

TABLE 1	
PART NUMBER	"B"
RPCE-XX-X-XX.XX-D-C5E	17.00 [.67]
RPCE-XX-X-XX.XX-BC-C5E	3.50 [.14]

DESIGNED & DIMENSIONED
IN MILLIMETERS[INCHES]

RPCE-XX-X-XX.XX-XX-C5E

CABLE STYLE
-01: OUTDOOR UL

PLATING SPECIFICATION
-E: .000050" GOLD ON CONTACT
AREAS, NICKEL ON SHELLS

END OPTION
-D: DOUBLE ENDED
-BC: BLUNT CUT
(SEE FIG. 2, SHEET 2)

CABLE LENGTH*
-XX.XX
(0.17M[6.69] MIN - 50.00M[1968.50] MAX)

DO NOT
SCALE FROM
THIS PRINT

* -00.25 AND -00.50 ARE CATALOG
STANDARD LENGTHS, FOR OTHER
LENGTHS CONTACT SAMTEC

**THIS PRODUCT MANUFACTURED
WITH LEAD-FREE PROCESSING**

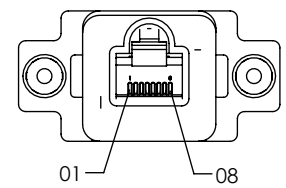
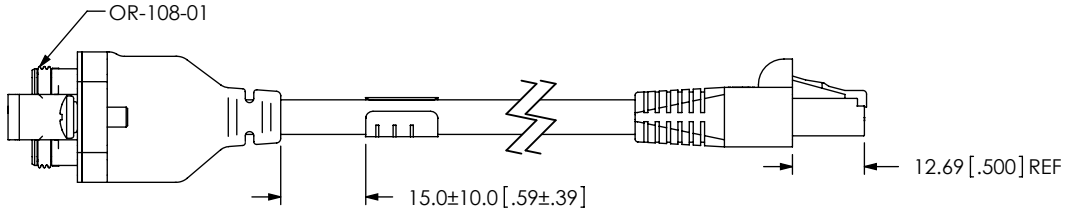
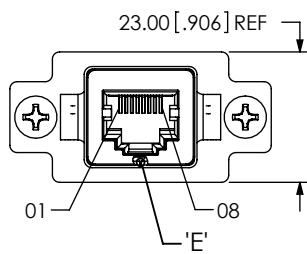
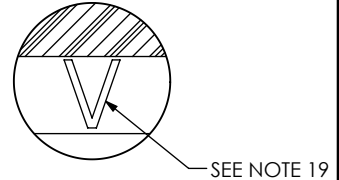
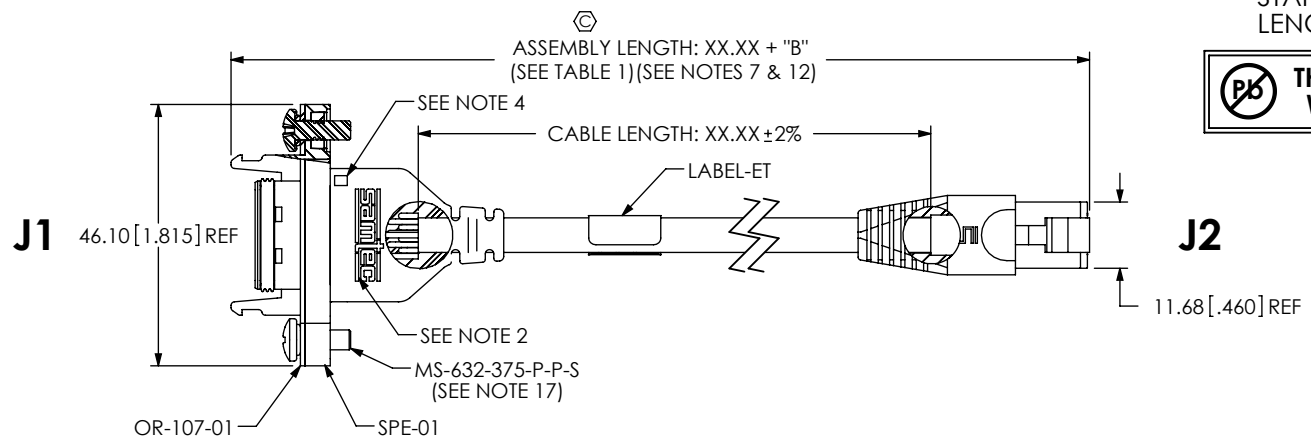


FIG. 1
RPCE-01-E-XX.XX-D-C5E SHOWN

NOTES:

- ⊗ REPRESENTS A CRITICAL DIMENSION.
- SAMTEC LOGO SHALL APPEAR AT ONE EQUALLY SPACED LOCATION ON SURFACE SHOWN, APPROXIMATELY 16.5[.724] x 5.0[.197].
- MOLDED SURFACES SHALL BE CONSISTENT AND SMOOTH. SURFACES TO BE FREE OF SCRATCHES, NICKS, SINK AREAS, VOIDS, OR OTHER BLEMISHES.
- ALL MULTIPLE CAVITY MOLDS SHALL IDENTIFY EACH CAVITY WITH A NUMBER DESIGNATION LOCATED WHERE SHOWN.
- ALL IDENTIFICATION MARKS SHALL NOT STAND GREATER THAN 0.05[.002] OFF THE SURFACE OF THE PART.
- MOLD TO BE INSERTED TO ACCEPT DIFFERENT CABLE DIAMETERS.
- ASSEMBLY TO BE 100% ELECTRICALLY TESTED TO CAT5CH USING FLUKE DTX-1800 CABLE ANALYZER. AFTER FINAL ELECTRICAL TEST, LABEL WITH 1 LABEL-ET.
- ALL EJECTION PIN AND GATE LOCATIONS MUST BE APPROVED BY SAMTEC PRODUCT ENGINEERING.
- ANY ADDITIONAL VOIDING AND/OR MODIFICATIONS TO VOIDING MUST BE APPROVED BY SAMTEC PRODUCT ENGINEERING.
- ALL DRAFT MUST BE WITHIN THE SPECIFIED TOLERANCES.
- ALL INSIDE/OUTSIDE RADII 0.13[.005] MAX UNLESS OTHERWISE STATED.
- TOLERANCE SHALL BE ±2% FOR ALL LENGTHS.
- PANEL THICKNESS: 0.08[.030] - 3.96[.156], RECOMMENDED PANEL CUT OUT ON SHEET 3.
- BURR ALLOWANCE: 0.038[.0015] MAX.
- MINIMUM PUSHOUT FORCE: 4.4N[1.00 LB].
- ASSEMBLY TO BE BULK PACKAGED.
- SEALING O-RING IS INCLUDED WITH MS-632-375-P-P-S.
- REQUIRED TORQUE ON MS-632-375-P-P-S: .32 ± .07 Nm [45 ± 10 IN-OZ].
- OR-108-XX POSITION INDICATOR.

UNLESS OTHERWISE SPECIFIED, DIMENSIONS ARE IN MILLIMETERS. TOLERANCES ARE: DECIMALS ANGLES X.X: ±0.3 [.01] 2° X.XX: ±0.13 [.005] X.XXX: ±0.051 [.0020]	PROPRIETARY NOTE THIS DOCUMENT CONTAINS INFORMATION CONFIDENTIAL AND PROPRIETARY TO SAMTEC, INC. AND SHALL NOT BE REPRODUCED OR TRANSFERRED TO OTHER DOCUMENTS OR DISCLOSED TO OTHERS OR USED FOR ANY PURPOSE OTHER THAN THAT WHICH IT WAS OBTAINED WITHOUT THE EXPRESSED WRITTEN CONSENT OF SAMTEC, INC.	samtec 520 PARK EAST BLVD., NEW ALBANY, IN 47150 PHONE: 812-944-6733 FAX: 812-948-5047 e-Mail: info@SAMTEC.com code 55322
MATERIAL: DO NOT SCALE DRAWING SHEET SCALE: 3:4 INSULATOR: GLASS FILLED THERMOPLASTIC CONTACT: PHOS BRONZE SHIELD: PHOS BRONZE OVERMOLD: RITE FLEX 640F SEAL: NBR NUT: STAINLESS STEEL SCREW: STAINLESS STEEL O-RING: SILICONE F:\DWG\MISC\MKTG\RPCE-XX-X-XX.XX-C5E-MKT.SLDDRW	DESCRIPTION: SEAL RECTANGULAR RECEPTACLE, ETHERNET DWG. NO. RPCE-XX-X-XX.XX-XX-C5E	BY: T NEWTON 12/10/2009 SHEET 1 OF 6

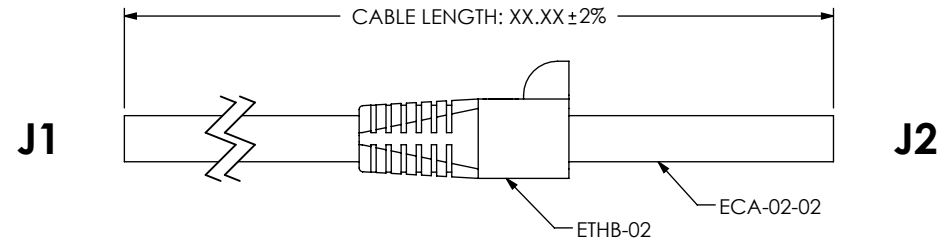
REVISION D

ASSEMBLY LENGTH: XX.XX + "B"
(SEE TABLE 1)(SEE NOTES 7 & 12)

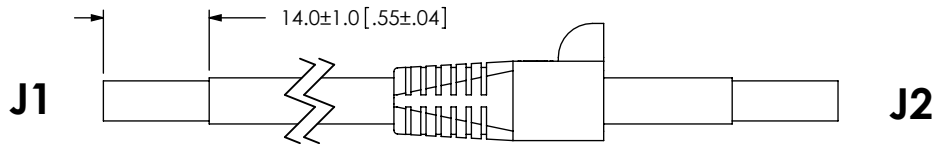


FIG. 2
RPCE-01-E-XX.XX-BC-C5E
(SAME AS FIG. 1, UNLESS OTHERWISE STATED)

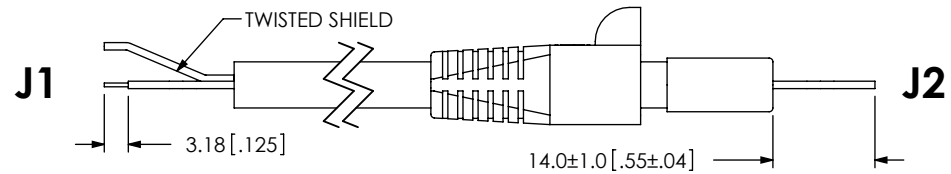
-D: IN-PROCESS 1
(CUT CABLE TO LENGTH AND ADD ETHB-02)



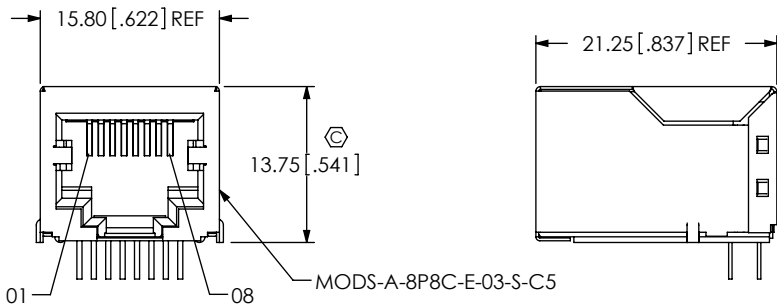
-D: IN-PROCESS 2
(STRIP OUTER JACKET)



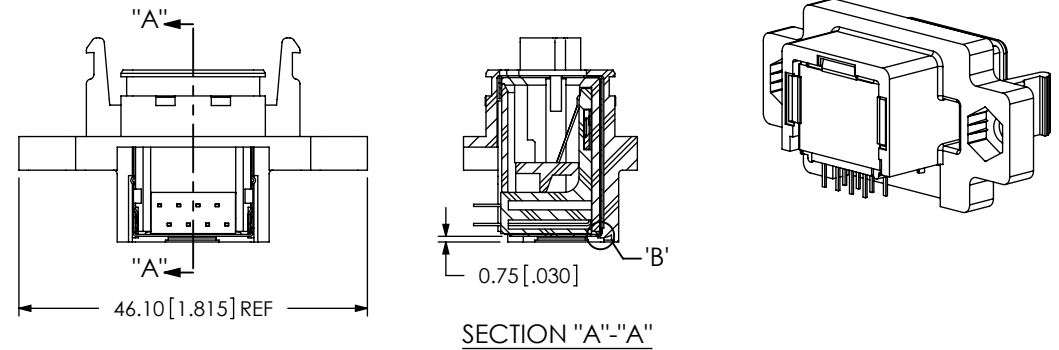
-D: IN-PROCESS 3
J1 END: TWIST SHIELD TO FORM SINGLE CONDUCTOR.
STRIP INDIVIDUAL WIRES TO DIMENSION SHOWN & TIN DIP
J2 END: FOLD BACK SHIELD



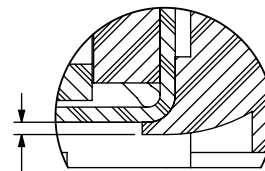
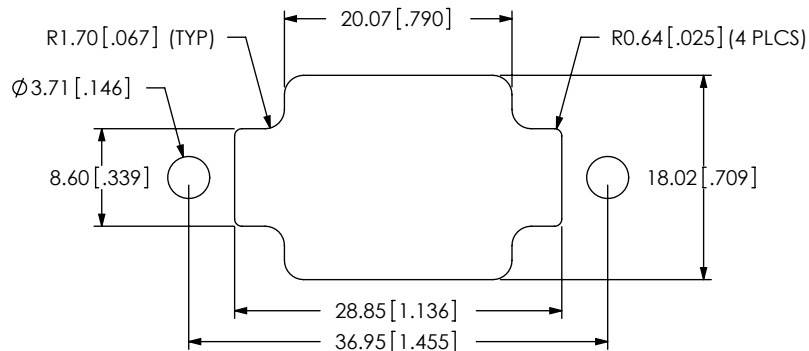
-D: IN-PROCESS 4
REMOVE SHIELD TAB FROM MODS-A-8P8C-E-03-S-C5



-D: IN-PROCESS 5
FILL SPE-01 & HEAT STAKE



RECOMMENDED PANEL CUT OUT
(SEE NOTE 13)



0.10 [0.004] MIN.
(AFTER HEAT STAKE)
(TYP)

DETAIL 'B'
SCALE 8:1

PROPRIETARY NOTE

THIS DOCUMENT CONTAINS INFORMATION CONFIDENTIAL AND PROPRIETARY TO SAMTEC, INC. AND SHALL NOT BE REPRODUCED OR TRANSFERRED TO OTHER DOCUMENTS OR DISCLOSED TO OTHERS OR USED FOR ANY PURPOSE OTHER THAN THAT WHICH IT WAS OBTAINED WITHOUT THE EXPRESSED WRITTEN CONSENT OF SAMTEC, INC.

DO NOT SCALE DRAWING

SHEET SCALE: 1:1

samtec

520 PARK EAST BLVD, NEW ALBANY, IN 47150
PHONE: 812-944-6733 FAX: 812-948-5047
e-Mail info@SAMTEC.com code 55322

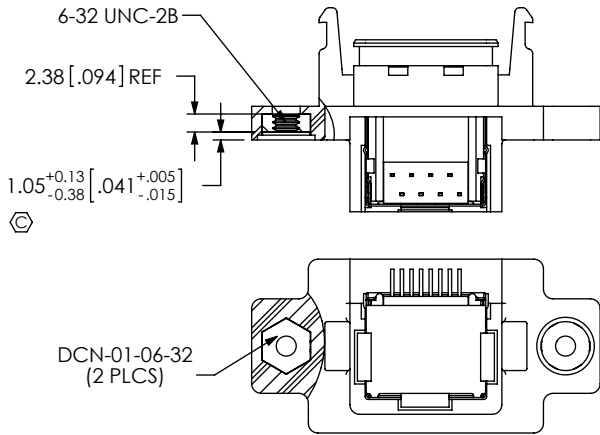
DESCRIPTION:
SEAL RECTANGULAR RECEPTACLE, ETHERNET

DWG. NO.
RPCE-XX-X-XX.XX-XX-C5E

BY: T NEWTON 12/10/2009 SHEET 2 OF 6

REVISION D

-D: IN-PROCESS 6
FILL DCN-01-06-32 & HEAT STAKE



-D: IN-PROCESS 7
SOLDER PCB-102392-01

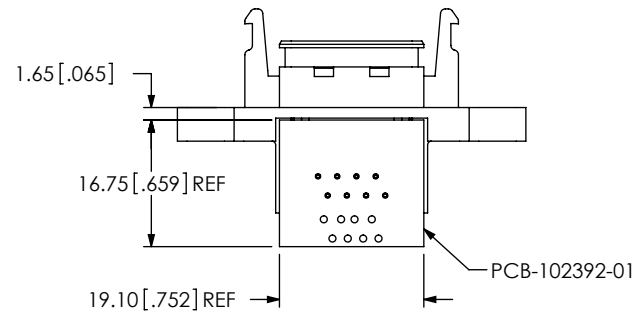
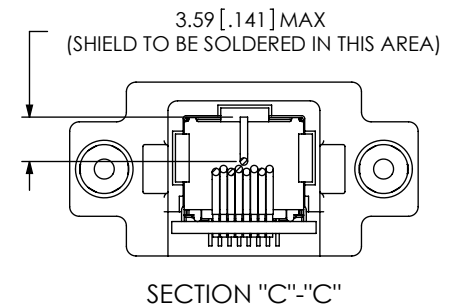
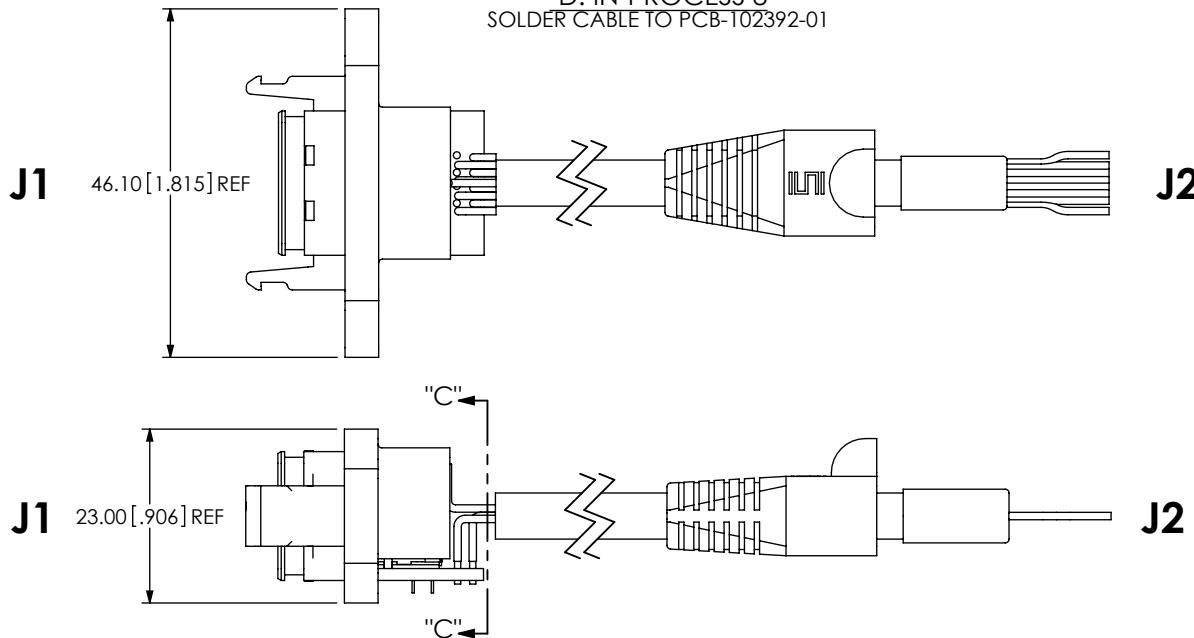


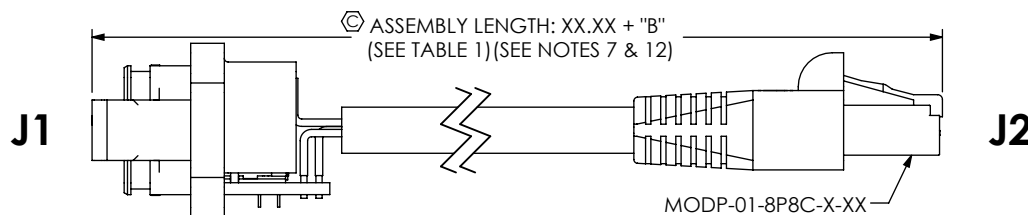
TABLE 2

J1 POS	COLOR	J2 POS
01	WHITE/ORANGE	01
02	ORANGE	02
03	WHITE/GREEN	03
04	BLUE	04
05	WHITE/BLUE	05
06	GREEN	06
07	WHITE/BROWN	07
08	BROWN	08
SHELL	BRAID	SHELL

-D: IN-PROCESS 8
SOLDER CABLE TO PCB-102392-01



-D: IN-PROCESS 9
TERMINATE J2 TO MODP-01-8P8C-X-XX



PROPRIETARY NOTE
THIS DOCUMENT CONTAINS INFORMATION CONFIDENTIAL AND PROPRIETARY TO SAMTEC, INC. AND SHALL NOT BE REPRODUCED OR TRANSFERRED TO OTHER DOCUMENTS OR DISCLOSED TO OTHERS OR USED FOR ANY PURPOSE OTHER THAN THAT WHICH IT WAS OBTAINED WITHOUT THE EXPRESSED WRITTEN CONSENT OF SAMTEC, INC.

DO NOT SCALE DRAWING

SHEET SCALE: 1:1

samtec

520 PARK EAST BLVD, NEW ALBANY, IN 47150
PHONE: 812-944-6733 FAX: 812-948-5047
e-Mail info@SAMTEC.com code 55322

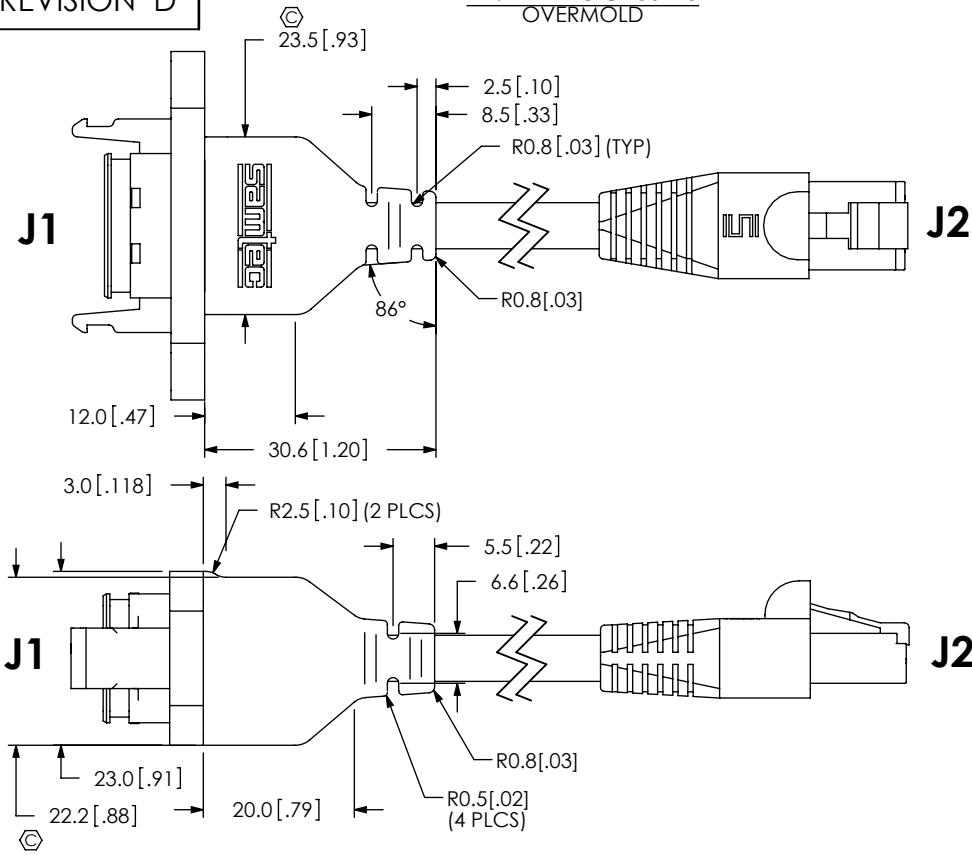
DESCRIPTION:
SEAL RECTANGULAR RECEPTACLE, ETHERNET

DWG. NO.
RPCE-XX-X-XX.XX-XX-C5E

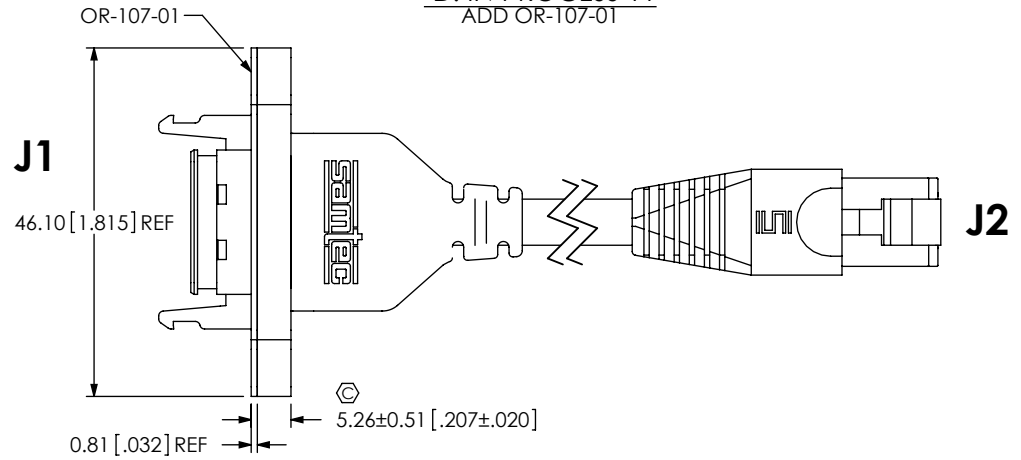
BY: T NEWTON 12/10/2009 SHEET 3 OF 6

REVISION D

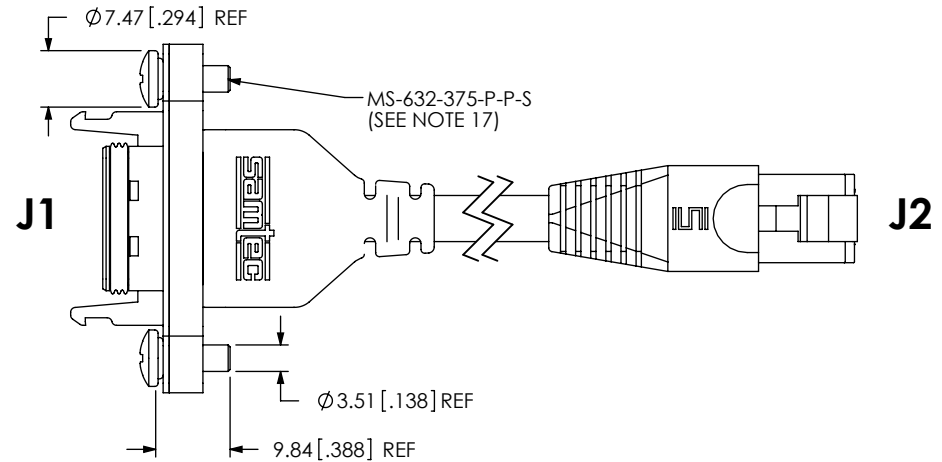
-D: IN-PROCESS 10
OVERMOLD



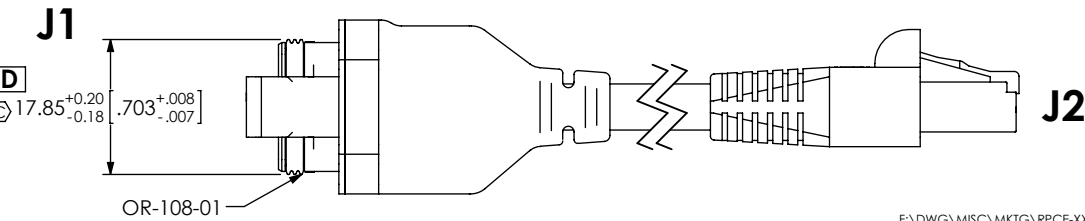
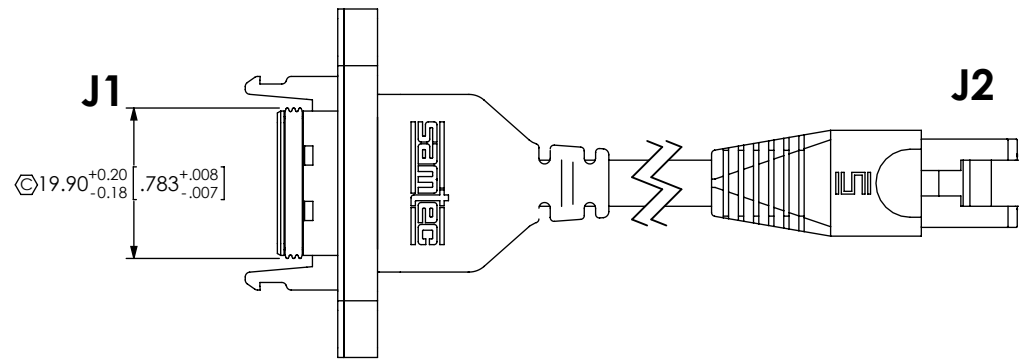
-D: IN-PROCESS 11
ADD OR-107-01



-D: IN-PROCESS 13
ADD MS-632-375-P-P-S



-D: IN-PROCESS 12
ADD OR-108-01



PROPRIETARY NOTE
THIS DOCUMENT CONTAINS INFORMATION
CONFIDENTIAL AND PROPRIETARY TO
SAMTEC, INC. AND SHALL NOT BE REPRODUCED
OR TRANSFERRED TO OTHER DOCUMENTS OR
DISCLOSED TO OTHERS OR USED FOR ANY
PURPOSE OTHER THAN THAT WHICH IT WAS
OBTAINED WITHOUT THE EXPRESSED WRITTEN
CONSENT OF SAMTEC, INC.

DO NOT SCALE DRAWING

SHEET SCALE: 1:1

samtec

520 PARK EAST BLVD, NEW ALBANY, IN 47150
PHONE: 812-944-6733 FAX: 812-948-5047
e-Mail info@SAMTEC.com code 55322

DESCRIPTION:
SEAL RECTANGULAR RECEPTACLE, ETHERNET

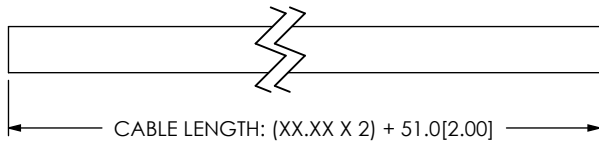
DWG. NO.
RPCE-XX-X-XX.XX-XX-C5E

BY: T NEWTON 12/10/2009 SHEET 4 OF 6

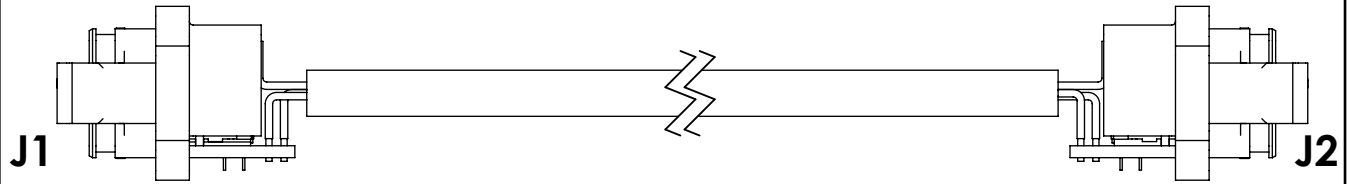
REVISION D

-BC: IN-PROCESS 1
CUT CABLE TO LENGTH

(SAME AS -D: IN-PROCESS 1, EXCEPT AS SHOWN)

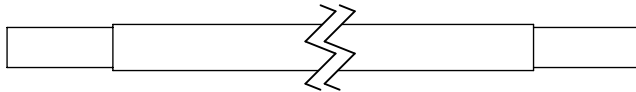


-BC: IN-PROCESS 8
TERMINATE CABLE TO PCB-T02392-01,
(SAME AS -D: IN-PROCESS 8, EXCEPT AS SHOWN)



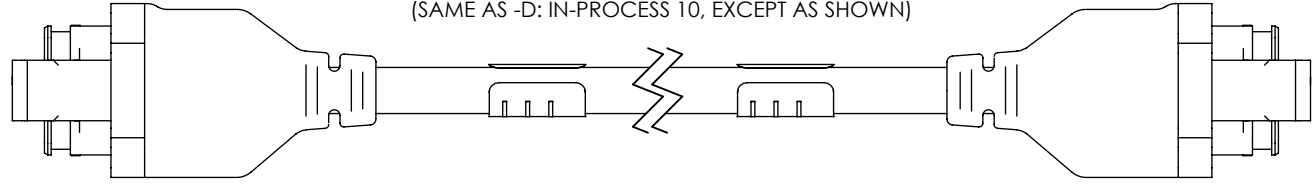
-BC: IN-PROCESS 2
STRIP OUTER JACKET

(SAME AS -D: IN-PROCESS 2, EXCEPT AS SHOWN)



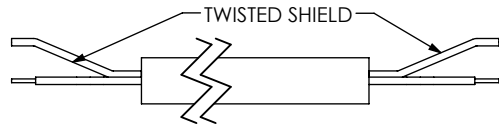
-BC: IN-PROCESS 9
OVERMOLD

(SAME AS -D: IN-PROCESS 10, EXCEPT AS SHOWN)



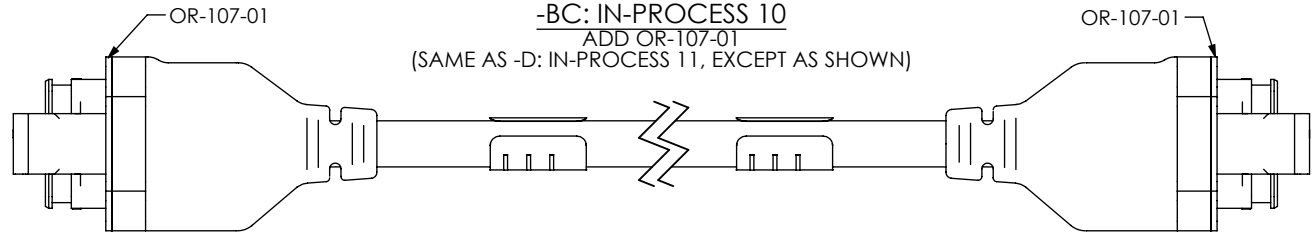
-BC: IN-PROCESS 3
STRIP INDIVIDUAL WIRE AND TIN DIP

(SAME AS -D: IN-PROCESS 3, EXCEPT AS SHOWN)

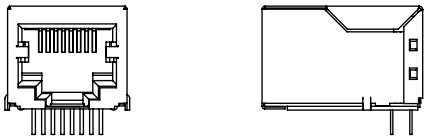


-BC: IN-PROCESS 10
ADD OR-107-01

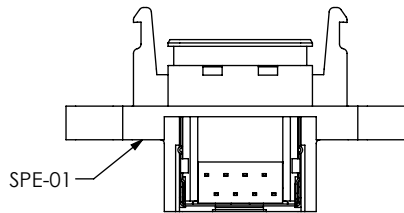
(SAME AS -D: IN-PROCESS 11, EXCEPT AS SHOWN)



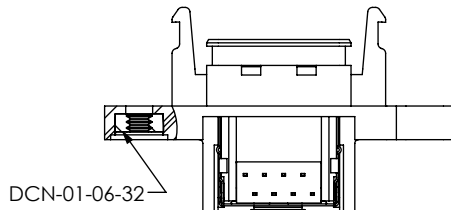
-BC: IN-PROCESS 4
REMOVE SHIELD TAB FROM MODS-A-8P8C-E-03-S-C5
(SAME AS -D: IN-PROCESS 4, EXCEPT AS SHOWN)



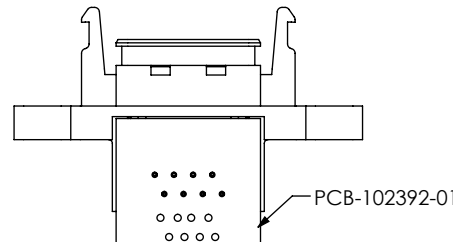
-BC: IN-PROCESS 5
FILL SPE-01 & HEAT STAKE
(SAME AS -D: IN-PROCESS 5, EXCEPT AS SHOWN)



-BC: IN-PROCESS 6
FILL DCN-01-06-32 & HEAT STAKE
(SAME AS -D: IN-PROCESS 6, EXCEPT AS SHOWN)



-BC: IN-PROCESS 7
SOLDER PCB-T02392-01
(SAME AS -D: IN-PROCESS 7, EXCEPT AS SHOWN)



F:\DWG\MISC\MKTG\RPCE-XX-X-XX-XX-XX-C5E-MKT.SLDDRW

PROPRIETARY NOTE
THIS DOCUMENT CONTAINS INFORMATION
CONFIDENTIAL AND PROPRIETARY TO
SAMTEC, INC. AND SHALL NOT BE REPRODUCED
OR TRANSFERRED TO OTHER DOCUMENTS OR
DISCLOSED TO OTHERS OR USED FOR ANY
PURPOSE OTHER THAN THAT WHICH IT WAS
OBTAINED WITHOUT THE EXPRESSED WRITTEN
CONSENT OF SAMTEC, INC.

DO NOT SCALE DRAWING

SHEET SCALE: 1:1

samtec

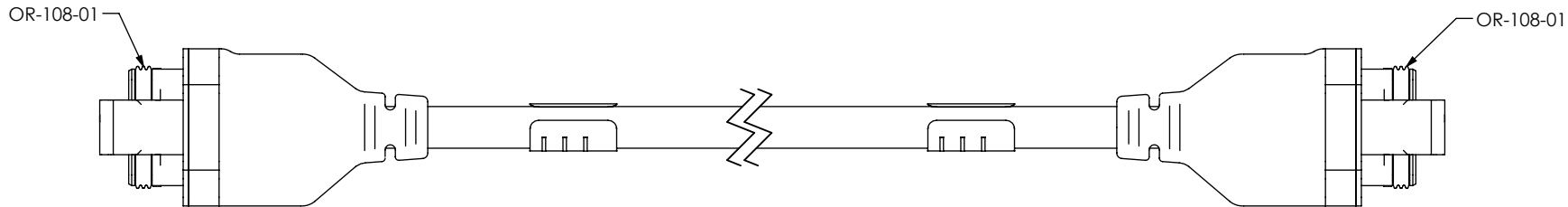
520 PARK EAST BLVD, NEW ALBANY, IN 47150
PHONE: 812-944-6733 FAX: 812-948-5047
e-Mail info@SAMTEC.com code 55322

DESCRIPTION:
SEAL RECTANGULAR RECEPTACLE, ETHERNET

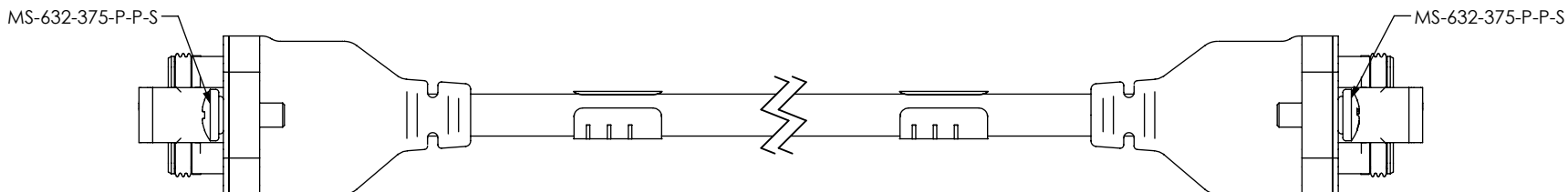
DWG. NO.
RPCE-XX-X-XX-XX-XX-C5E

BY: T NEWTON 12/10/2009 SHEET 5 OF 6

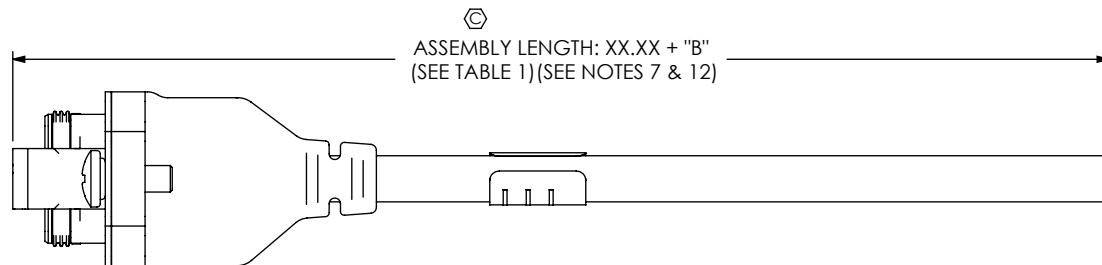
-BC: IN-PROCESS 11
 ADD OR-108-01
 (SAME AS -D: IN-PROCESS 12, EXCEPT AS SHOWN)



-BC: IN-PROCESS 12
 ADD MS-632-375-P-P-S
 (SAME AS -D: IN-PROCESS 13, EXCEPT AS SHOWN)



-BC: IN-PROCESS 13
 CUT CABLE IN HALF AND TRIM TO LENGTH



PROPRIETARY NOTE
 THIS DOCUMENT CONTAINS INFORMATION
 CONFIDENTIAL AND PROPRIETARY TO
 SAMTEC, INC. AND SHALL NOT BE REPRODUCED
 OR TRANSFERRED TO OTHER DOCUMENTS OR
 DISCLOSED TO OTHERS OR USED FOR ANY
 PURPOSE OTHER THAN THAT WHICH IT WAS
 OBTAINED WITHOUT THE EXPRESSED WRITTEN
 CONSENT OF SAMTEC, INC.

DO NOT SCALE DRAWING

SHEET SCALE: 1:1



520 PARK EAST BLVD, NEW ALBANY, IN 47150
 PHONE: 812-944-6733 FAX: 812-948-5047
 e-Mail info@SAMTEC.com code 55322

DESCRIPTION:
 SEAL RECTANGULAR RECEPTACLE, ETHERNET

DWG. NO.
RPCE-XX-X-XX.XX-XX-C5E

BY: T NEWTON 12/10/2009 SHEET 6 OF 6