

Optocoupler, Phototransistor Output, High Reliability, 5300 V_{RMS}

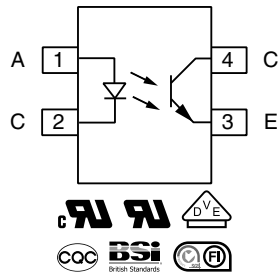

FEATURES

- Operating temperature from - 55 °C to + 110 °C
- Good CTR linearity depending on forward current
- Isolation test voltage, 5300 V_{RMS}
- High collector emitter voltage, V_{CEO} = 80 V
- Low saturation voltage
- Fast switching times
- Low CTR degradation
- Temperature stable
- Low coupling capacitance
- End stackable, 0.100" (2.54 mm) spacing
- High common mode interference immunity
- Material categorization: For definitions of compliance please see www.vishay.com/doc?99912

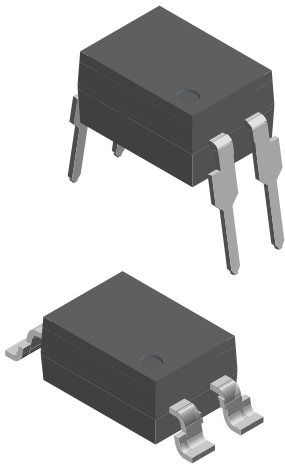

DESCRIPTION

The 110 °C rated VO618A feature a high current transfer ratio, low coupling capacitance and high isolation voltage. These couplers have a GaAs infrared diode emitter, which is optically coupled to a silicon planar phototransistor detector, and is incorporated in a plastic DIP-4 package.

The coupling devices are designed for signal transmission between two electrically separated circuits.

The couplers are end-stackable with 2.54 mm spacing.

Creepage and clearance distances of > 8.0 mm are achieved with option 6. This version complies with IEC 60950 (DIN VDE 0805) for reinforced insulation up to an operation voltage of 400 V_{RMS} or DC. Specifications subject to change.

APPLICATIONS

- AC adapters
- SMPS
- PLC
- Factory automation
- Game consoles

AGENCY APPROVALS

- UL1577, file no. E52744
- cUL tested to CSA 22.2 bulletin 5A
- DIN EN 60747-5-5 (VDE 0884-5), available with option 1
- BSI IEC 60950; IEC 60065
- FIMKO EN 60065, EN 60950-1
- CQC GB8898-2001

ORDERING INFORMATION

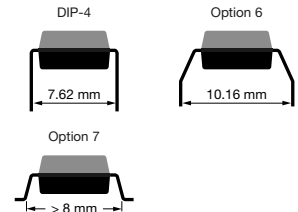
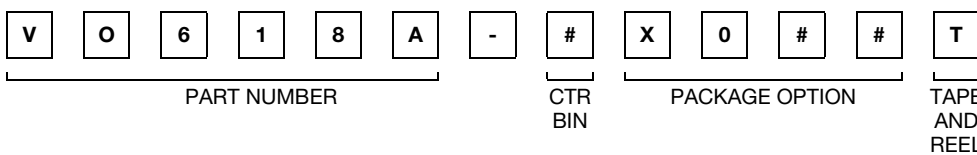

AGENCY CERTIFIED/PACKAGE	CTR (%)			
	1 mA			
UL, cUL, BSI, FIMKO	50 to 600	63 to 125	100 to 200	160 to 320
DIP-4	VO618A	VO618A-2	VO618A-3	VO618A-4
VDE, UL, cUL, BSI, FIMKO	50 to 600	63 to 125	100 to 200	160 to 320
DIP-4, 400 mil, option 6	-	-	-	VO618A-4X016
SMD-4, option 7	-	-	VO618A-3X017T	VO618A-4X017T

Note

- Additional options may be possible, please contact sales office.

ABSOLUTE MAXIMUM RATINGS ($T_{amb} = 25\text{ }^{\circ}\text{C}$, unless otherwise specified)				
PARAMETER	TEST CONDITION	SYMBOL	VALUE	UNIT
INPUT				
Reverse voltage		V_R	6	V
Forward current		I_F	60	mA
Forward surge current	$t_p \leq 10\text{ }\mu\text{s}$	I_{FSM}	2.5	A
LED power dissipation	at $25\text{ }^{\circ}\text{C}$	P_{diss}	70	mW
OUTPUT				
Collector emitter voltage		V_{CEO}	80	V
Emitter collector voltage		V_{ECO}	7	V
Collector current		I_C	50	mA
Collector peak current	$t_p/T = 0.5, t_p \leq 10\text{ ms}$	I_{CM}	100	mA
Output power dissipation	at $25\text{ }^{\circ}\text{C}$	P_{diss}	150	mW
COUPLER				
Isolation test voltage (RMS)	$t = 1\text{ min}$	V_{ISO}	5300	V_{RMS}
Total power dissipation		P_{tot}	200	mW
Operation temperature		T_{amb}	- 55 to + 110	$^{\circ}\text{C}$
Storage temperature range		T_{stg}	- 55 to + 150	$^{\circ}\text{C}$
Soldering temperature ⁽¹⁾	2 mm from case, $\leq 10\text{ s}$	T_{sld}	260	$^{\circ}\text{C}$

Notes

- Stresses in excess of the absolute maximum ratings can cause permanent damage to the device. Functional operation of the device is not implied at these or any other conditions in excess of those given in the operational sections of this document. Exposure to absolute maximum ratings for extended periods of the time can adversely affect reliability.

⁽¹⁾ Refer to reflow profile for soldering conditions for surface mounted devices (SMD), and wave profile for soldering conditions for through hole devices (DIP), please go to "Assembly Instructions" (www.vishay.com/doc?80054).

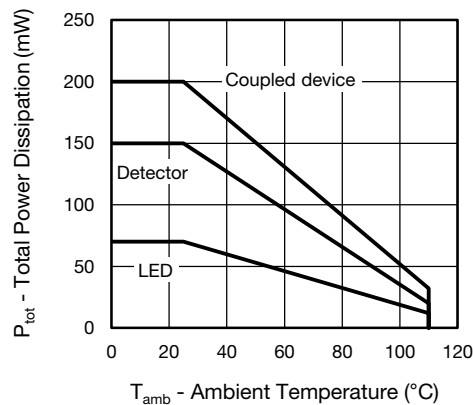

Fig. 1 - Total Power Dissipation vs. Ambient Temperature

**ELECTRICAL CHARACTERISTICS** ($T_{amb} = 25\text{ }^{\circ}\text{C}$, unless otherwise specified)

PARAMETER	TEST CONDITION	SYMBOL	MIN.	TYP.	MAX.	UNIT
INPUT						
Forward voltage	$I_F = 5\text{ mA}$	V_F	1	1.15	1.65	V
Reverse current	$V_R = 6\text{ V}$	I_R		0.01	10	μA
Junction capacitance	$V_R = 0\text{ V}, f = 1\text{ MHz}$	C_j		13		pF
OUTPUT						
Collector emitter leakage current	$V_{CE} = 10\text{ V}$	I_{CEO}		10	200	nA
Collector emitter capacitance	$V_{CE} = 5\text{ V}, f = 1\text{ MHz}$	C_{CE}		5.2		pF
Collector emitter breakdown voltage	$I_C = 1\text{ mA}$	BV_{CEO}	80			V
Emitter collector breakdown voltage	$I_E = 100\text{ }\mu\text{A}$	BV_{ECO}	7			V
COUPLER						
Collector emitter saturation voltage	$I_F = 1\text{ mA}, I_C = 2.5\text{ mA}$	V_{CEsat}		0.25	0.4	V
Coupling capacitance	$f = 1\text{ MHz}$	C_C		0.4		pF

Note

- Minimum and maximum values are testing requirements. Typical values are characteristics of the device and are the result of engineering evaluation. Typical values are for information only and are not part of the testing requirements.

CURRENT TRANSFER RATIO ($T_{amb} = 25\text{ }^{\circ}\text{C}$, unless otherwise specified)

PARAMETER	TEST CONDITION	PART	SYMBOL	MIN.	TYP.	MAX.	UNIT
I_C/I_F	$I_F = 1\text{ mA}, V_{CE} = 5\text{ V}$	VO618A	CTR	50		600	%
		VO618A-2	CTR	63		125	%
		VO618A-3	CTR	100		200	%
		VO618A-4	CTR	160		320	%

SWITCHING CHARACTERISTICS ($T_{amb} = 25\text{ }^{\circ}\text{C}$, unless otherwise specified)

PARAMETER	TEST CONDITION	CTR BIN	SYMBOL	MIN.	TYP.	MAX.	UNIT
NON-SATURATED							
Rise and fall time	$I_F = 1\text{ mA}, V_{CC} = 5\text{ V}, R_L = 75\text{ }\Omega$		t_r, t_f		2		μs
Turn-on time	$I_F = 1\text{ mA}, V_{CC} = 5\text{ V}, R_L = 75\text{ }\Omega$		t_{on}		3		μs
Turn-off time			t_{off}		2.3		μs
Cut-off frequency	$I_F = 1\text{ mA}, V_{CC} = 5\text{ V}, R_L = 75\text{ }\Omega$		f_{ctr}		100		kHz
SATURATED							
Turn-on time	$I_F = 1\text{ mA}$		t_{on}		4.2		μs
Turn-off time	$I_F = 1\text{ mA}$		t_{off}		23		μs
Rise time	$I_F = 1\text{ mA}$		t_r		3		μs
Fall time	$I_F = 1\text{ mA}$		t_f		14		μs

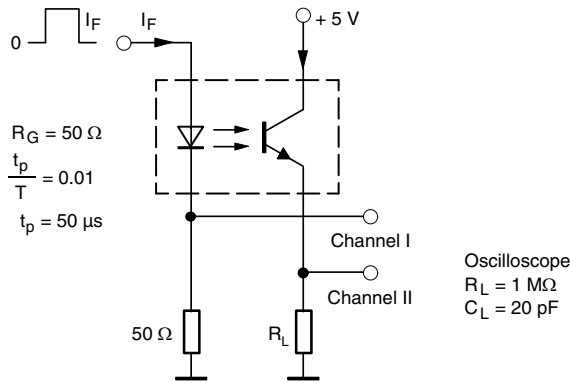

95 10804-3

Fig. 2 - Test Circuit, Non-Saturated Operation

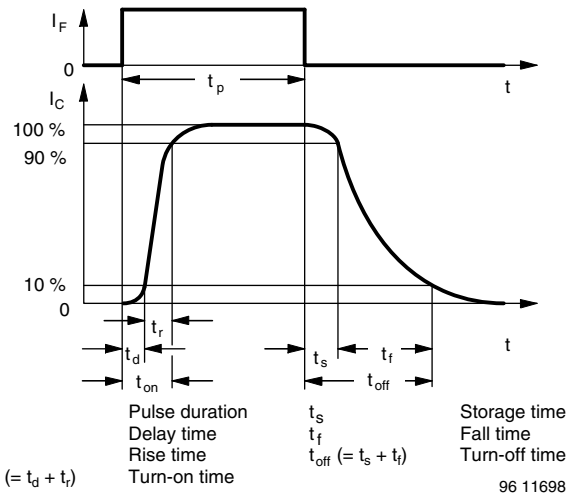
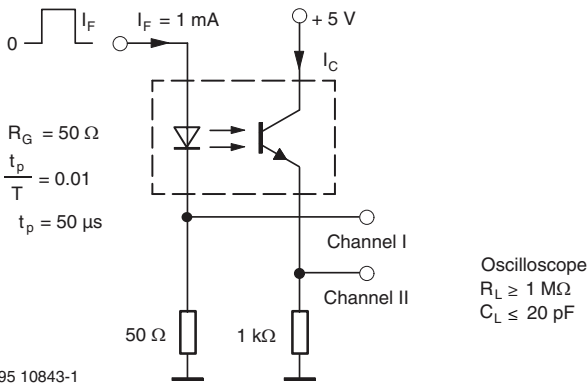

Fig. 4 - Switching Times



95 10843-1

Fig. 3 - Test Circuit, Saturated Operation

SAFETY AND INSULATION RATINGS				
PARAMETER		SYMBOL	VALUE	UNIT
MAXIMUM SAFETY RATINGS				
Output safety power		P _{SO}	265	mW
Input safety current		I _{si}	130	mA
Safety temperature		T _S	150	°C
Comparative tracking index		CTI	175	
INSULATION RATED PARAMETERS				
Maximum withstanding isolation voltage		V _{ISO}	5300	V _{RMS}
Maximum transient isolation voltage		V _{IOTM}	8000	V _{peak}
Maximum repetitive peak isolation voltage		V _{IORM}	890	V _{peak}
Insulation resistance	T _{amb} = 25 °C, V _{DC} = 500 V	R _{IO}	10 ¹²	Ω
Insulation resistance	T _{amb} = 100 °C, V _{DC} = 500 V	R _{IO}	10 ¹¹	Ω
Climatic classification (according to IEC 68 part 1)			55/110/21	
Environment (pollution degree in accordance to DIN VDE 0109)			2	
Internal and external creepage	Standard DIP-4		≥ 7	mm
	400 mil DIP-4		≥ 8	mm
Clearance	Standard DIP-4		≥ 7	mm
	400 mil DIP-4		≥ 8	mm
Insulation thickness			0.4	mm

Note

- As per DIN EN 60747-5-5, § 7.4.3.8.2, this optocoupler is suitable for “safe electrical insulation” only within the safety ratings. Compliance with the safety ratings shall be ensured by means of protective circuits.

TYPICAL CHARACTERISTICS ($T_{amb} = 25\text{ }^{\circ}\text{C}$, unless otherwise specified)

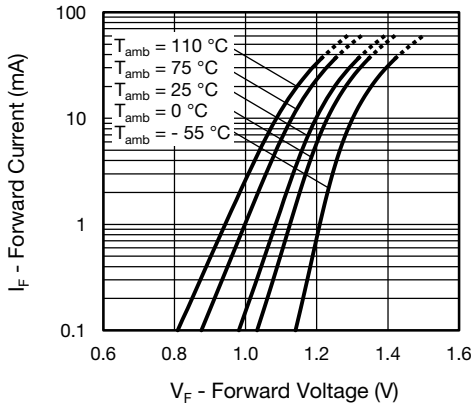

Fig. 5 - Forward Voltage vs. Forward Current

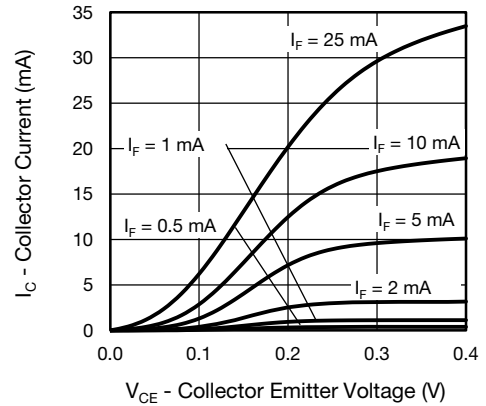

Fig. 8 - Collector Current vs. Collector Emitter Voltage (saturated)

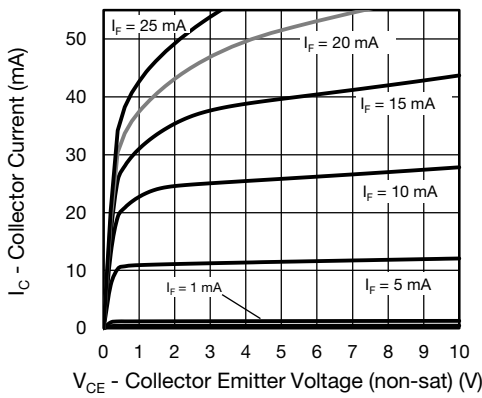

Fig. 6 - Collector Current vs. Collector Emitter Voltage (non-saturated)

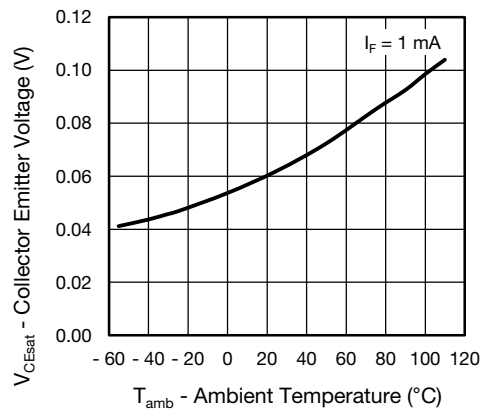

Fig. 9 - Collector Emitter Voltage vs. Ambient Temperature (saturated)

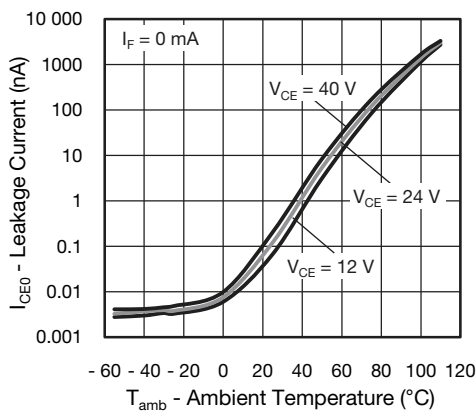

Fig. 7 - Collector Emitter Current vs. Ambient Temperature

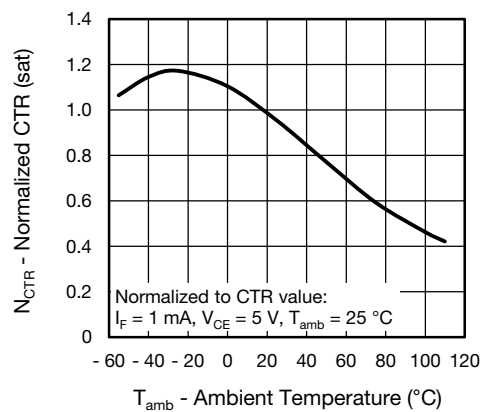

Fig. 10 - Normalized Current Transfer Ratio vs. Ambient Temperature (saturated)

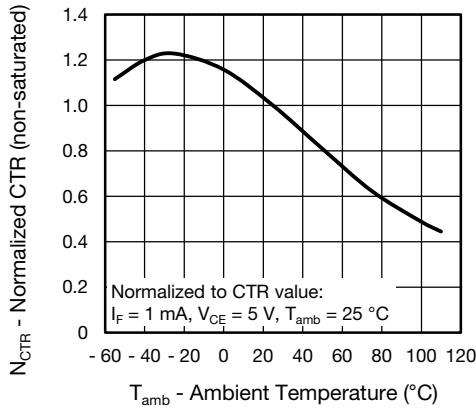

Fig. 11 - Normalized Current Transfer Ratio vs. Ambient Temperature (non-saturated)

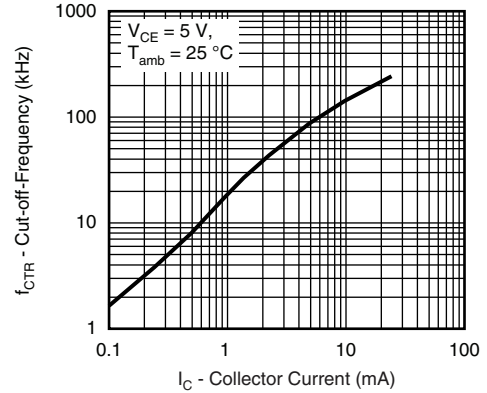

Fig. 14 - Cut-off Frequency (-3 dB) vs. Collector Current

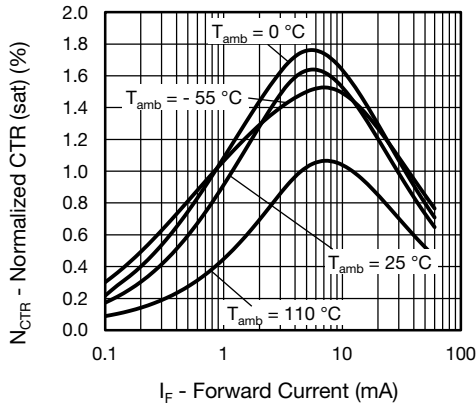

Fig. 12 - Current Transfer Ratio vs. Forward Current (saturated) normalized to 1 mA at 25 °C

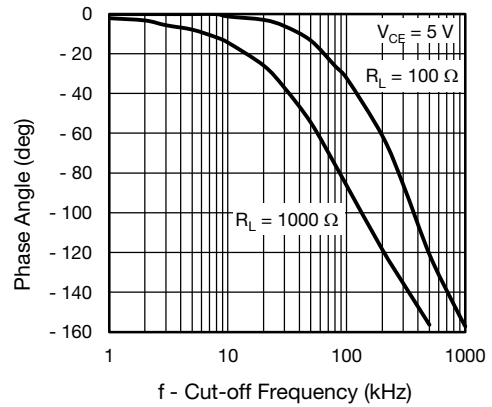

Fig. 15 - F_{CTR} vs. Phase Angle

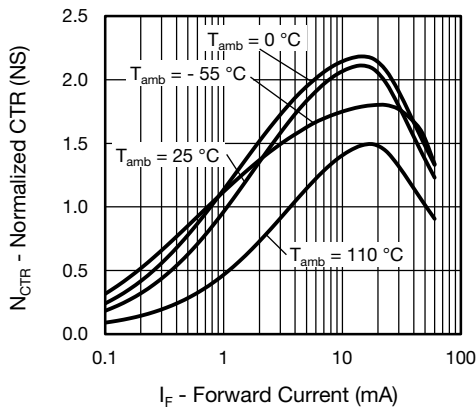

Fig. 13 - Current Transfer Ratio vs. Forward Current (non-saturated) normalized to 1 mA at 25 °C

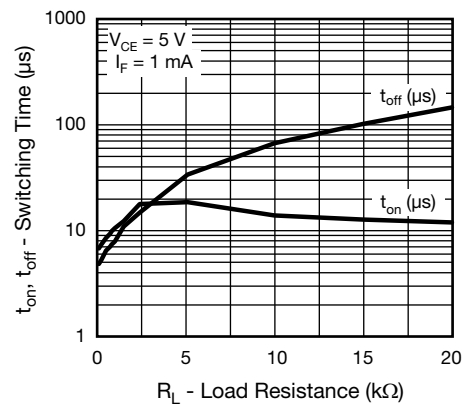

Fig. 16 - Switching Time vs. Load Resistance

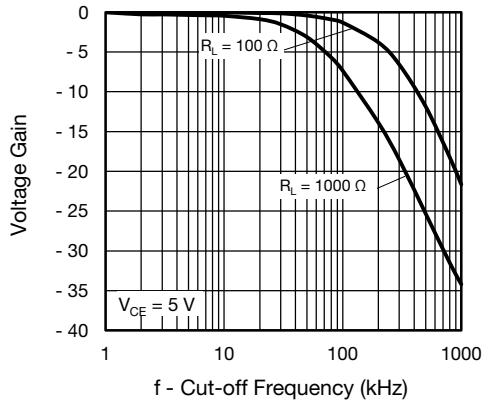
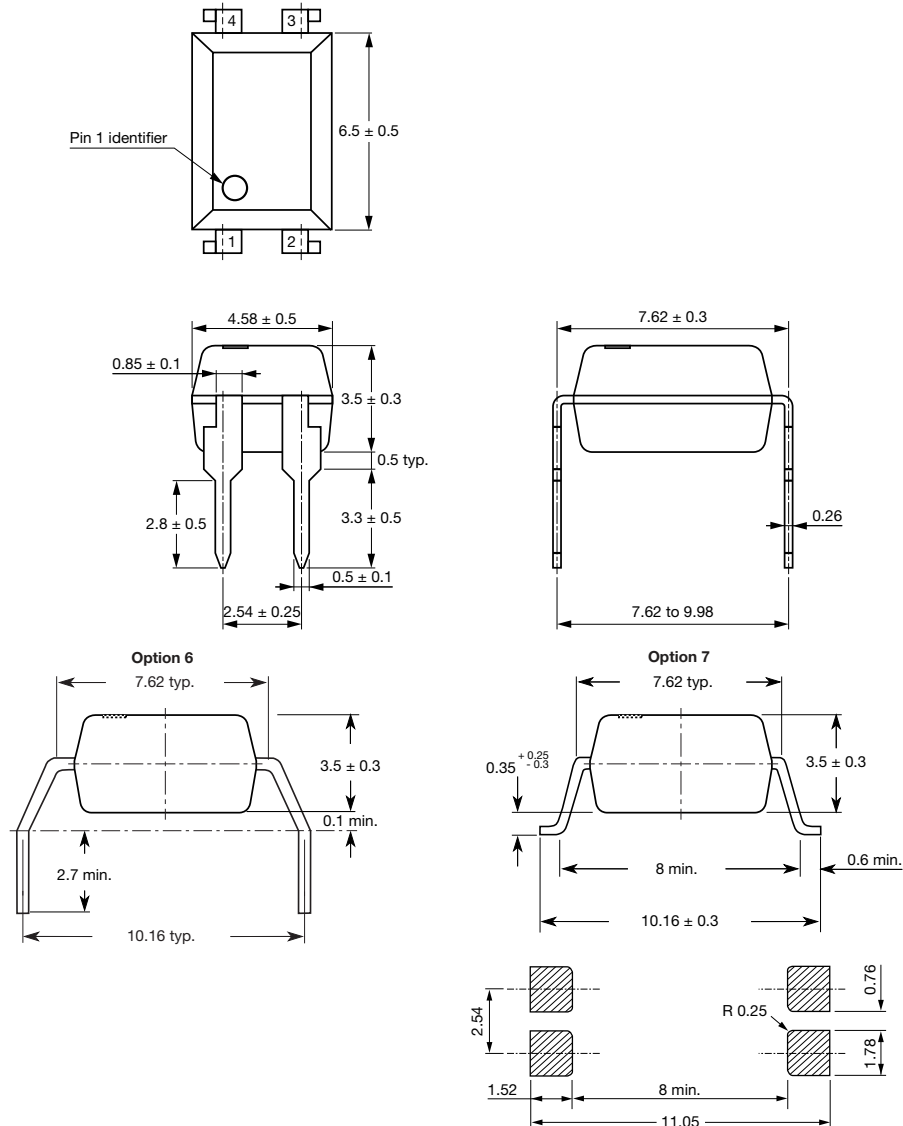
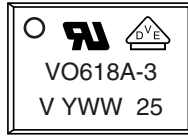

Fig. 17 - Voltage Gain vs. Cut-off Frequency

PACKAGE DIMENSIONS in millimeters



PACKAGE MARKING (example of VO618A-3X017T)



Notes

- The VDE logo is only marked on option 1 parts. Option information is not marked on the part.
- Tape and reel suffix (T) is not part of the package marking.

PACKING INFORMATION

DEVICE PER TUBE			
TYPE	UNITS/TUBE	TUBES/BOX	UNITS/BOX
DIP-4	100	40	4000

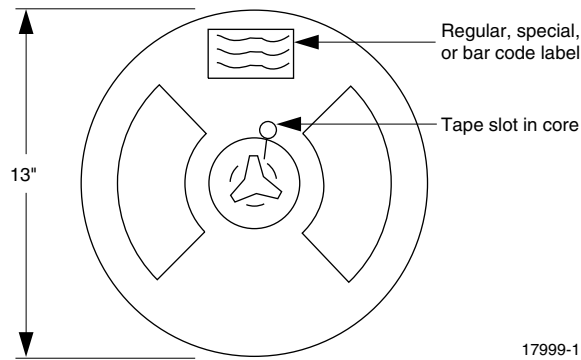

Fig. 18 - Tape and Reel Shipping Medium (1000 units per reel)

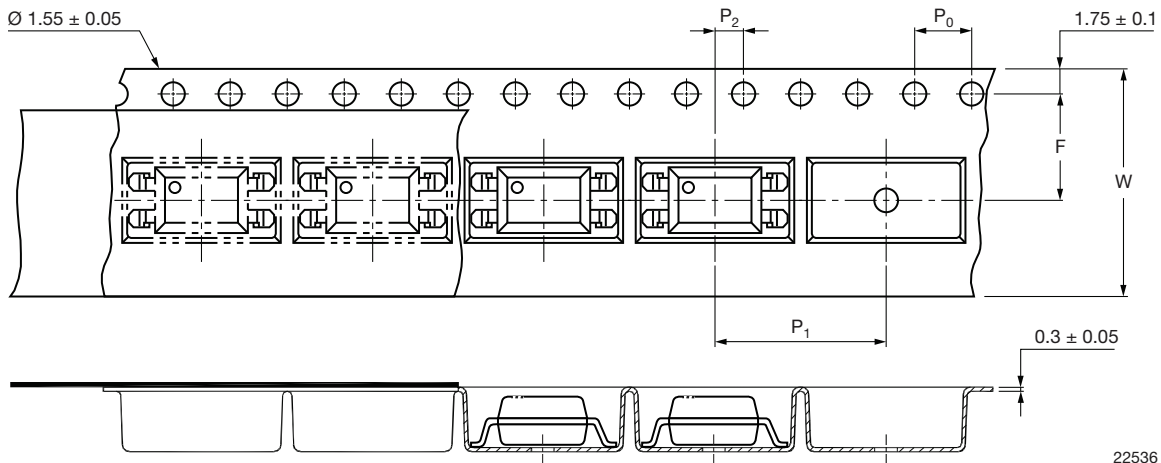

Fig. 19 - Tape and Packing for Option 7