



Inspired Wireless M2M Technology



ZEST Series

GPRS/UMTS Wireless Modem with
RS232 Interface

Hardware Reference Manual
Rev 1.9

Table of Contents

	Page		
Introduction	3	Power	29
About Siretta	4	ZEST-GPRS USB Power Connector	29
General Description	5	Power Connector (2-pin 3.5mm Pluggable Terminal Block)	30
Specifications	6	Power Supply Requirements	31
AT Commands	7	Current Consumption	33
ZEST Interface	8	Switching the Modem ON/OFF	34
System Diagram	10	Embedded Software Support	36
System Overview	11	Telit AppZone	36
Modes of Operation	12	Telit Easy Script in Python	37
Ordering Information	13	Siretta Recommends	38
Dimensions	14	Installation	40
DIN Rail Mount	16	Considerations for Installations Incorporating the ZEST	40
Mounting the ZEST	16	Power Supply Installation	41
Removing the ZEST	16	Securing the Modem	41
ZEST Series Images	17	Safety and Product Care	42
ZEST LED Indicator	18	General Precautions	42
Modem States	19	SIM Card Precautions	42
Interfaces	20	Antenna Precautions	43
RS232 Serial Port Interface	20	Exposure to RF Energy	43
RS485 Serial Port Interface (Optional)	22	Safety Recommendations	45
ZEST-UMTS USB Serial Port Interface	23	Conformity Assessment	46
USB Interface Drivers	24	Disclaimer	47
SIM Socket	26	Definitions	48
SIM Requirements	26		
Antenna Connector	27		
GSM/UMTS Antenna Connector	27		

Introduction

This document is intended to provide guidance when adding a modem from the ZEST Series to your system.

The ZEST series of GPRS/UMTS M2M modems are a low cost range of modems developed for easy integration into existing systems and for embedded application development.

The ZEST modem range is based on the Telit xL865 GPRS/UMTS module series without GPS. The modem manages the module power up sequence and can be programmed to perform additional custom tasks.

This document discusses the modems hardware and software states and modes of operation, in addition to the electrical characteristics of the modems interfaces.

About Siretta

Siretta, located in Reading, United Kingdom have been manufacturing antennas, cable assemblies and cellular modems for over 10 years. We supply our products globally to many of the world's leading organizations.

Whether you require an off the shelf or custom solution, Siretta has a wide portfolio of antenna, RF cable assemblies and modems to fit your application.

Our extensive knowledge and experience in the wireless market allows us to support a wide range of customer applications, focusing on frequencies typically within the 75MHz - 5.8GHz range. These encompass the HF, VHF, ISM, GSM/GPRS/3G/4G and GPS frequencies as well as industrial WLAN and VHF/UHF antenna/Wi-Fi antenna solutions.

With a heavy emphasis on design, we have a team of dedicated Application Engineers and Product Managers, backed up by Field Sales Engineers, who specialise in wireless applications.

We have made significant investments in R&D facilities which boast GPS hardware development equipment and a GSM Pico Cell on site, as well as development software and a comprehensive suite of Industrial, Scientific and Medical band, and non ISM band frequency products. We have many technology partners enabling us to keep at the forefront of the communications industry and offer class leading wireless solutions.

General Description

The ZEST range of wireless modems is a compact cellular modem with RS232 port (RS232 and USB on 3G model) and plastic housing, offering state-of-the-art 2G/3G connectivity for machine to machine (M2M) applications.

Features

- » Control via AT commands (Hayes 3GPP TS 27.007 and 27.005)
- » TCP/IP, SMS and CSD access via AT commands
- » 1 x RS232 serial port
- » 1 x mini USB 2.0 high speed interface (available on 3G model only)
- » Wide range input voltages
- » Extreme operating temperature
- » The plastic enclosure can be mounted on a DIN-rail or on the wall

Specifications

Table 1. Specifications of the ZEST modem

	ZEST-GPRS	ZEST-UMTS
Standards:	GSM/GPRS/EDGE	GSM/GPRS/EDGE/UMTS/HSDPA/HSPA+
2G frequency band:	900, 1800MHz (EU Version)	900, 1800MHz (EU Version)
3G frequency band:	-	900, 2100MHz (EU Version)
Dimensions:	75 x 84 x 31mm	75 x 84 x 31mm
Weight:	105g	105g
Input voltage:	6 - 18V	6 - 21V
Power consumption:	Idle: 50 - 60mA @ 12V	Idle: 50 - 60mA @ 12V
Operating environment:	-40 to +85°C 5 to 95% RH	-40 to +85°C 5 to 95% RH
GSM antenna connector:	SMA Female	SMA Female
USB interface:	Mini USB (Power only)	Mini USB 2.0 (Serial data and power)

AT Commands

The ZEST range of wireless modems has a GSM engine at its heart which can be controlled via the serial interface using standard AT commands.

The AT command is an ATTENTION command and is used as a prefix to other parameters in a formatted string. The AT command combined with other parameters can be sent to the modem with your preferred modem emulator package (TMSTerm/TeraTerm/HyperTerminal) and typed in manually as a command line instruction.

The wireless module is compliant with the following AT command formats:

- 1) Hayes standard AT command set, in order to maintain the compatibility with existing SW programs.
- 2) 3GPP 27.007 specific AT command and GPRS specific commands.
- 3) 3GPP 27.005 specific AT commands for SMS (Short Message Service) and CBS (Cell Broadcast Service)
- 4) FAX Class 1 compatible commands
- 5) Proprietary command set, the module family also supports a proprietary set of AT commands for special purposes outside of the standard AT specification.

To obtain the latest AT command reference guide* with a full list of supported AT commands, please contact your Siretta representative or alternatively visit:

www.siretta.co.uk

NOTE - This following document refers to useful AT commands throughout and offers descriptions of how to use the AT commands with the ZEST wireless modems.

*For GPRS modems refer to the GPRS AT Command Manual, for UMTS modems refer to the UMTS AT Command Manual.

ZEST Interface

Standard Hardware Interfaces

The ZEST series modem comes with the following interfaces:

- » 1 x RS232 serial port interface for direct serial connection to module
- » ZEST-GPRS: 1 x mini USB (Power only)
ZEST-UMTS: 1 x mini USB 2.0 (Serial data and power)
- » 1 x power connector (2-pin 3.5mm pluggable terminal block)
- » 1 x SMA female GSM antenna connector
- » 1 x SIM card reader (push-push)
- » 1 x external LED status indicator (Green)

Cellular Interface

The ZEST series modem comes with the following cellular interfaces:

- » GPRS: Max 6.8kbps (DL & UL), Class 10
- » EDGE: Max 236.8kbps (DL & UL), Class 12
- » UMTS: Max 384kbps (DL & UL)
- » HSDPA: Max 3.6Mbps / 384kbps (DL / UL)
- » HSPA+: Max 7.2 / 5.76Mbps (DL / UL)
- » CSD: Up to 9.6kbps

RS232 Serial Interface

The ZEST series modem comes with the following RS232 port interfaces:

- » ESD protection: 15KV
- » Parameters: 1200bps to 115200bps
- » RS232: DCD, RxD, TxD, DTR, GND, DSR, RTS, CTS, RI

USB Port Interface

The ZEST series modem comes with the following USB port interfaces:

- » ESD protection: 15KV
- » 5V power supply for modem

Optional Modem Features*

Optional Hardware

The ZEST series modems have the following optional hardware features:

- » RS485 serial port (serial interface: Data+ (A), Data- (B), GND)

Optional Technologies

The ZEST series modems have the following optional technologies available:

- » European GPRS (2G)
- » European UMTS (3G)

Optional Coverage

The ZEST series modems have the following coverage options available:

- » (EU) European Union
- » (NA) North America

*To add optional features on your modem, see ordering Information on [page 13](#)

System Diagram

The ZEST is the latest in the Siretta range of cellular modems. It is the lowest cost of the range and is ideal if all you need is straightforward GPRS connectivity - simply. It competes strongly on its robust and industrial spec using Telit technology and with RS232 and USB interfaces*.

Figure 1. ZEST system diagram

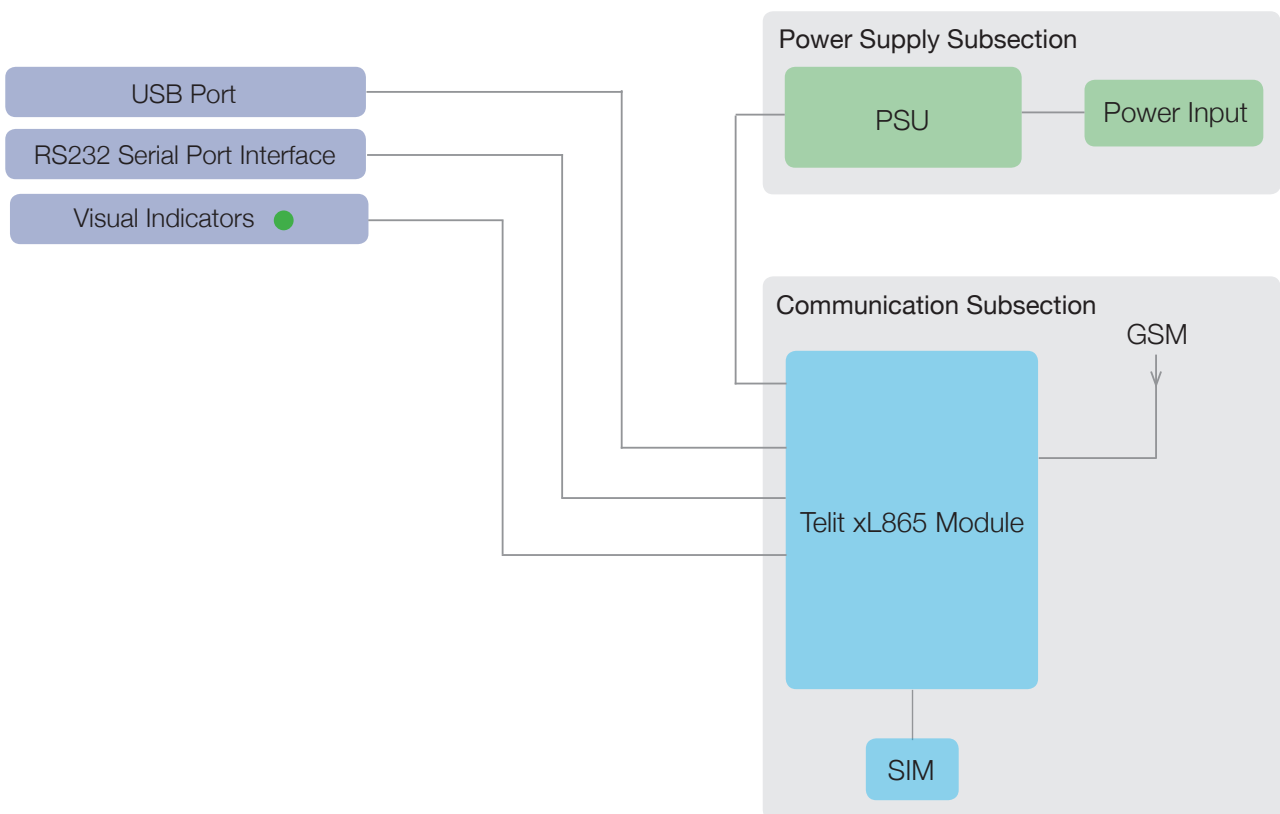

* USB interface only provides power for ZEST-GPRS and provides serial data and power for ZEST-UMTS.

System Overview

This ZEST can be used in a number of applications, some examples are shown below:

- » GPIO Monitor (Monitor/Set and report on GPIO status)
- » Standard RS232 modem attached to existing equipment (PC/MAC/Server etc.)

Typically connected devices are:

- » PC/MAC/Linux platforms for use as modem
- » Embedded (connected directly to remote equipment without a PC attached)

Operating System Connected Modem

- » Internet enable a remote device with RS232 connectivity over 2.5G/3G. Internet connectivity can be retrofitted to end equipment without changing the software or configuration of the remote device.
- » Used in countries or places where broadband and WiFi is a less common method to connect to the internet or where services are unavailable. The ZEST modem can overcome this restriction by providing a mobile internet solution over the GPRS/3G network.

Examples:

- » Vending machine where the head office would poll for drinks remaining/money taken etc. This would be an on-demand pull to obtain results in real time.
- » Monitoring AMR/temperature/equipment in a home, i.e. Interrogate lights etc.*
- » Monitoring GPIO, i.e. Open doors/windows*
- » Remote entry system, i.e. Send a message to the modem to open a gate/door to allow access.*
- » Streaming live data from remote system to a central location
- » Remote printing applications (remotely print over the GPRS network)
- » Polling remote devices for information to prevent an engineer callout

Modes of Operation

USB Interface

This is a USB standard Communication Device Class (CDC) device. This is provided with a driving for the OS, i.e. a standard OS supported driver.

***NOTE:** Requires additional hardware not supplied with the ZEST. Please speak to your Siretta representative for more information.

Ordering Information

ZEST - X - XXXX

Modem Identifier

ZEST = Wireless Modem with RS232 and USB Serial Port Interfaces

Module Type

N = Without GPS

Product Module Version

GPRS (EU) = European Coverage of GPRS Technology
 GPRS (NA) = North American Coverage of GPRS Technology
 UMTS (EU) = European Coverage UMTS Technology
 UMTS (NA) = North American Coverage of UMTS Technology

Part Numbering Examples

- » ZEST-N-GPRS (EU) = EU Coverage GPRS Wireless Modem with RS232 Interface, without GPS

Dimensions

All dimensions are shown in mm. The mounting holes are suitable for a M3 fixing screwing. These drawings are relevant for the entire ZEST series modems.

Figure 2. ZEST modem front view - dimensions

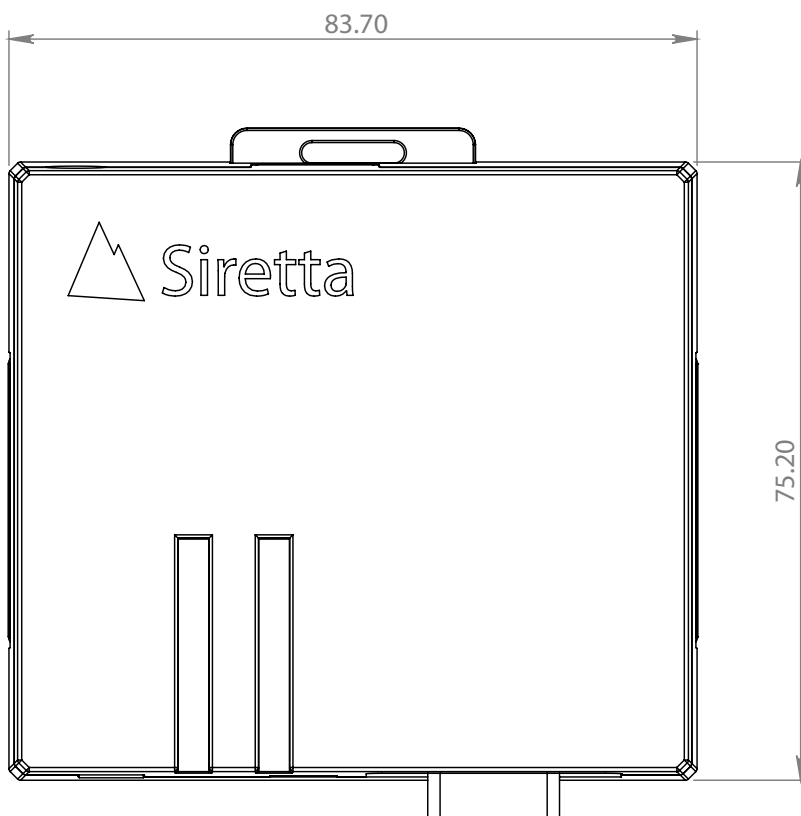
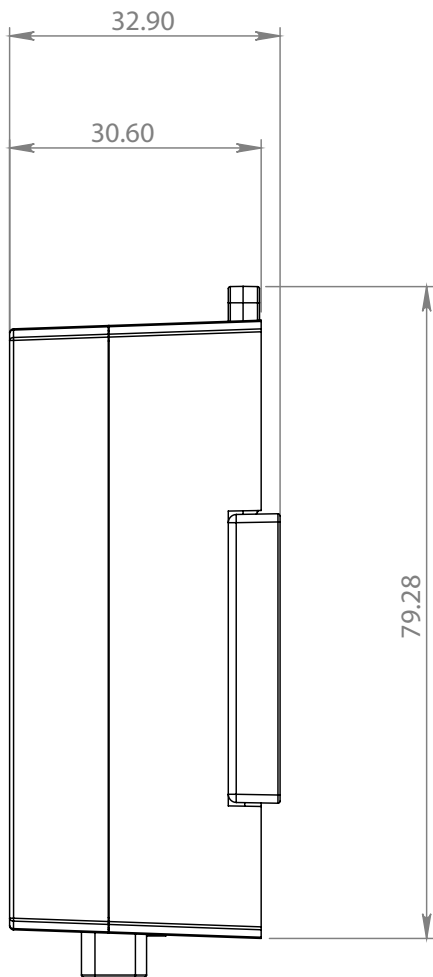

Figure 3. ZEST modem side view - dimensions



DIN Rail Mount

The ZEST has an integrated DIN rail mount housing which allows the unit to connect on to the standard rail widely used for mounting industrial control equipment inside equipment racks. This has been adopted as a European (EN) and International (ISO) Standard.

Mounting the ZEST

Figure 4. Mounting ZEST to DIN rail

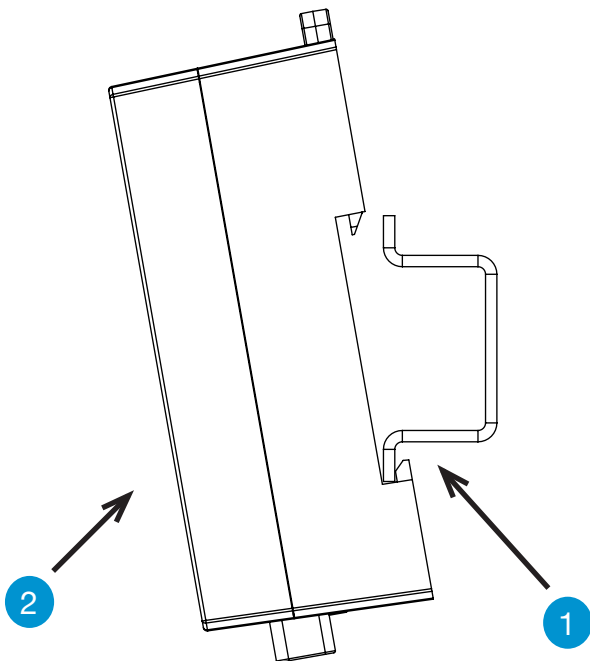

- 1 Hook the bottom modem DIN rail clip onto the bottom of the DIN rail
- 2 Push modem 45° until the top DIN rail clip locks onto the top of DIN rail

Removing the ZEST

Figure 5. Removing ZEST from DIN rail

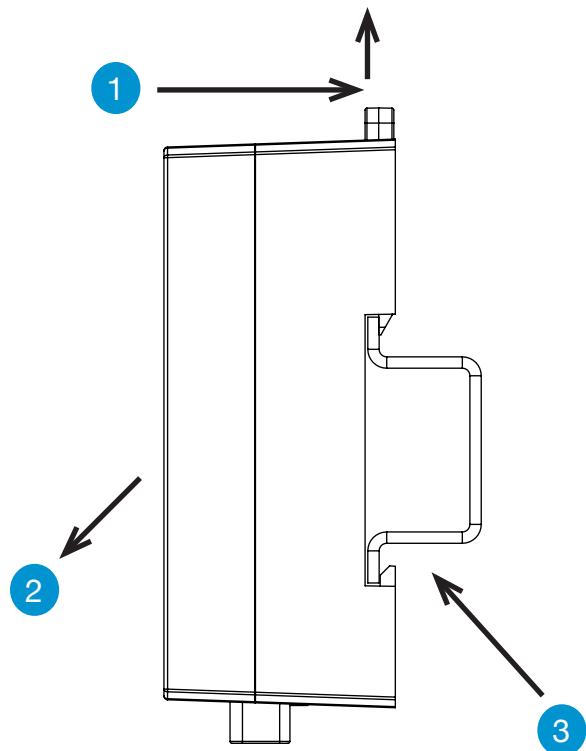

- 1 Slide DIN rail clip upwards
- 2 Pull modem 45° until the top DIN rail clip unlocks from the top of DIN rail
- 3 Slide modem down, until bottom DIN rail clip unlocks from the bottom of the DIN rail

ZEST Series Images

Figure 6. 3D view of the ZEST



Figure 7. ZEST power, USB & RS232 interfaces

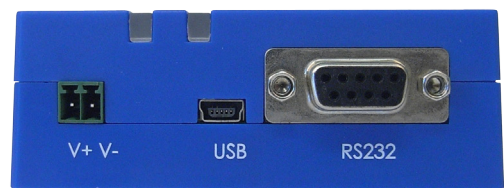

Figure 8. ZEST - DIN rail mounted



ZEST LED Indicator

The ZEST has 1 LED output that easily indicates the functional/operational state of the modem.

Figure 9. LED

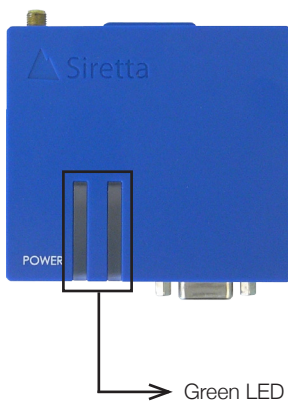

Table 2. LED status

Name	Colour	Status	Description
POWER	Green	ON	ZEST is powered on
POWER	Green	OFF	ZEST is powered off

Modem States

The current modem state and function is shown below in **table 3**.

Table 3. Modem states (assume AT#SLED=2*)

Current Modem State	Input	Next state	Indication of new state
Power Off	Connect power	Run Mode	Green LED will be on continuously
Run Mode	Insert a valid SIM card	On Network	Green LED will be on continuously
On Network	Remove power	Power off	No activity on LED
Run Mode	Remove power	Power off	No activity on LED
Power Off	Connect power	Run Mode	Green LED will be on continuously
Run Mode	Insert a valid SIM card	On Network	Green LED will be on continuously

NOTE - Normal Operation: When the modem is first switched on with a valid SIM card, the green LED will be on continuously. The modem will attempt to join a network and should take about 10-15 seconds (this may vary considerably) whilst the modem searches for the network. During this period you can determine the registration status of the network using the AT command 'AT+CREG?' which will return one of 4 states as shown below:

- +CREG: 0,1 – Indicates that the modem is registered to the home network
- +CREG: 0,2 – Indicates that the modem is searching for a network
- +CREG: 0,3 – Indicates that the modem has been denied network access
- +CREG: 0,4 – Indicates that the modem has a network problem
- +CREG: 0,5 – Indicates that the modem is registered to a roaming network

If the response '+CREG:0,2' is returned for a long period of time (more than 5 minutes) then this suggests that there may be a problem with the SIM setup, the network signal or the antenna connection.

Interfaces

RS232 Serial Port Interface

This connector provides a serial RS232 communication between the ZEST modem and the connected equipment. The modem can be configured via the RS232 connection using AT commands as specified in the AT command manual.

Figure 10. RS232 serial port

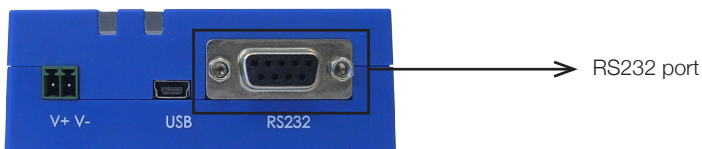

Figure 11. Pin numbering

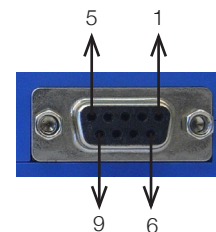

Table 4. Pin usage

Key:

NC = Not Connected

C = Connected

Pin	Name	Direction	Status GPRS	Status UMTS	Direction
1	DCD	Output from UART that indicates the carrier is present	NC	C	OUT
2	RXD	Output transmit line of UART	C	C	OUT
3	TXD	Input receive line of UART	C	C	IN
4	DTR	Input to UART and controls DTE ready condition	NC	C	IN
5	GND	Ground	C	C	IN
6	DSR	Output from UART that indicates the module is ready	NC	C	OUT
7	RTS	Request to Send - Input line of UART that controls hardware flow control	C	C	IN
8	CTS	Clear to Send - Output line of UART that controls hardware flow control	C	C	OUT
9	RI	Ring Indicator - Output line of UART that indicates the incoming call condition	NC	C	OUT

RS232 Male to RS232 Female Cable

The RS232 serial cable is the standard cable used for connecting the ZEST modem to other devices such as a PC or industrial control equipment. The RS232 serial cable allows a serial connection to the modem which you can use to setup and change the modem configuration as well as providing a communication channel for connected equipment over the GSM/UMTS network. Please turn to **page 38** for ordering details.

Figure 12. RS232 Male to RS232 Female Cable

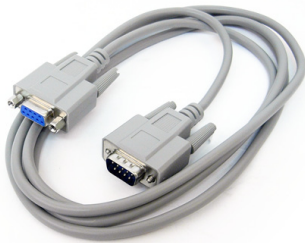

RS232 Male to USB Cable

The RS232 Male to USB cable allows you to connect to the RS232 serial port which is the standard cable used for connecting the ZEST modem to other devices such as a PC or industrial control equipment. The USB to RS232 Male serial cable allows a serial connection to the modem via USB which you can use to setup and change the modem configuration as well as providing a communication channel for connected equipment over the GSM/UMTS network. Please turn to **page 38** for ordering details.

Figure 13. RS232 Male to USB Cable



RS485 Serial Port Interface (Optional)

This connector provides a serial RS485 communication between the ZEST modem and the connected equipment. The modem can be configured via the Rs485 connection using AT commands as specified in the AT command manual.

Figure 14. RS485 serial port

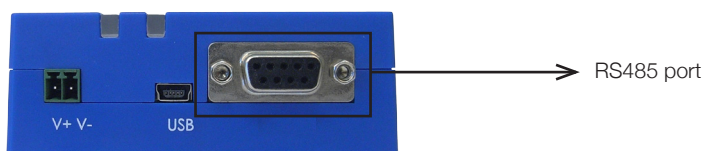

Figure 15. Pin numbering

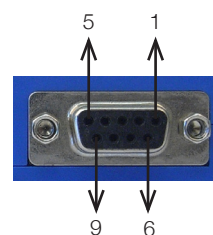

Table 5. Pin usage

Pin	Name	Direction	Status	Direction
1	Data+ (A)	RS485 Differential Data Positive	Connected	IN/OUT
2			Not Connected	
3			Not Connected	
4			Not Connected	
5			Not Connected	
6	Data- (B)	RS485 Differential Data Negative	Connected	IN/OUT
7			Not Connected	
8			Not Connected	
9			Not Connected	

For more information about the optional ZEST RS485 interface, please contact your Siretta representative or call us on +44(0)118 976 9014.

ZEST-UMTS USB Serial Port Interface

A mini USB type B connector is provided for USB serial connection*. When the ZEST-UMTS USB interface is used for sending/receiving data as well as power supply, the current/voltage output of the USB interface can reach at least 1A/5V. Pins on this connector are shown in **table 6** below.

Figure 16. ZEST-UMTS USB Connector

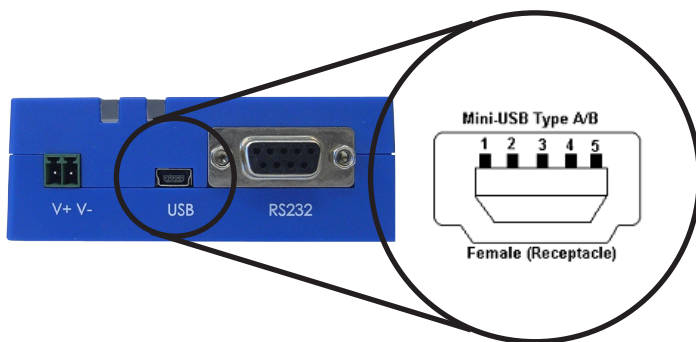

Table 6. Mini USB Connectors

Pin	Name	Direction	Description	Low Level	Nominal	High Level
1	VBUS	Input	USB Power VBUS	4.75V	5V	5.25V
2	D-	Differential	Data Minus	4.75V	5V	5.25V
3	D+	Differential	Data Plus	4.75V	5V	5.25V
4	-	-	-	-	-	-
5	GND	Input	Signal Ground	-	0V	-

*Serial connection is only available with the ZEST-UMTS. To see functionality of the USB port on the ZEST-GPRS, see [page 29 ZEST-GPRS USB Power Connector](#).

ZEST-UMTS USB to Mini USB Cable

The USB to Mini USB cable allows you to connect to the ZEST-UMTS modem via the standard USB port. The Mini USB cable connects the modem to other devices such as a PC or industrial control equipment. The USB to Mini USB serial cable allows a serial connection to the modem via USB which you can use to setup and change the modem configuration as well as providing a communication channel for connected equipment over the GSM/UMTS network. Please turn to **page 38** for ordering details.

Figure 17. USB to Mini USB Cable



ZEST-UMTS USB Interface Drivers

The ZEST-UMTS series modems support a standard USB 2.0 device interface compatible with USB 2.0 specifications and supporting the USB low-speed [1.5 Mb/s] and full-Speed (12 Mb/s) modes. The USB port can be used to send AT-commands, reprogram the modems and view debug output. The maximum baud rate available to communicate with the ZEST-UMTS series modems is up to 12 Mbit/s.

Drivers are required to use the USB port and are available for several operating systems including Windows/Linux. Please contact Siretta for more information.

In HSDPA (High Speed Downlink Packet Access) mode, the downlink data speed rates can be up to 7.2Mbps. To achieve this network data rate using the ZEST-UMTS, integrators need to interface the ZEST to their applications in full-speed (12 Mb/s) mode.

The device driver creates 6 virtual COM ports on the system for access to the module. 4 of these ports can be configured for use as general purpose AT command communication ports or as GPS NMEA communication ports depending on the module version.*

USB0 → AT Command Interface 1

USB1 → Trace Port

USB2 → Unused

USB3 → AT Command Interfaces 2

USB4 → Unused

USB5 → Unused

The ZEST-UMTS series modems do not support autobauding. Integrators have to set the correct speed for serial communication before device initialization. If the right speed is set, the device responds with OK. The default baudrate is 115200.

To change the baudrate:

- » Send command AT+IPR=<rate><cr>
- » Wait for 'OK' response

*Please see the following command 'AT#PORTCFG' to configure these ports on your modem.

Supported baudrates	<CR>
» 2400	Carriage return
» 4800	
» 9600	
» 19200	
» 38400	
» 57600	
» 115200	
» 230400	

SIM Socket

The ZEST modem supports fixed SIMs locked to a network and roaming SIMs which can operate on more than one network within the home country. This allows for least cost routing for roaming mobile data and machine to machine applications where signal strength is variable in any given area and network selection is required.

The ZEST also supports global roaming SIMs which will work with any network it can detect, at home or abroad and can be chosen for best performance.

Figure 18. SIM holder

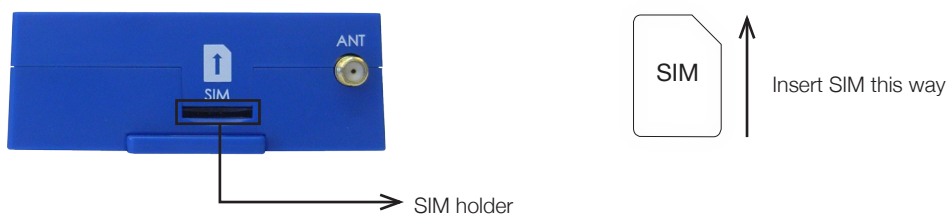

SIM Requirements

1.8V/3.3V Mini SIM (2FF) supported on the ZEST modem.

SIM services available for the ZEST GPRS series include:

- » 2G GSM (900/1800MHz)
- » SMS,
- » GPRS
- » CSD

SIM services available for the ZEST UMTS series include:

- » 2G GSM (900/1800MHz)
- » 3G UMTS (900/2100MHz)
- » SMS
- » GPRS
- » CSD

Figure 19. SIM card dimensions

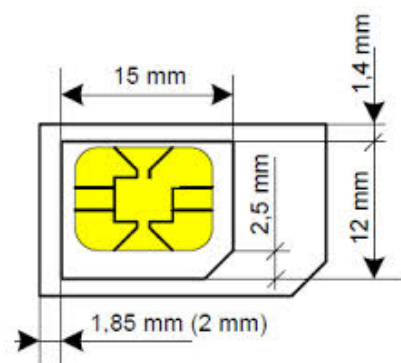

NOTE - 3G only SIM will not be supported on 2G GSM only modem. Please ensure SIM is 2G and 3G capable for greatest compatibility.

Antenna Connector

Figure 20. Antenna connector

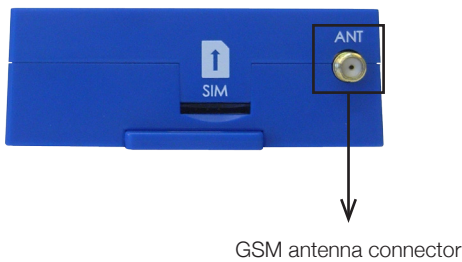

Antenna Placement

When in service the antenna should be placed away from electronic devices or other antennas. The recommended minimum distance between adjacent antennas, operating on a similar radio band, is at least 50cm.

Antenna Connection Cable

If a cable is used to connect the modem to the antenna this cable must be a high quality low loss cable. The cable and any connectors used should have 50 ohms impedance.

GSM/UMTS Antenna Connector

A female SMA connector is provided to allow connection of a passive antenna. For optimum performance the antenna assembly connected to this modem is required to have the following characteristics:

- » For 2G GSM operation specified operation in the following bands: GSM 900/1800MHz
- » For 3G UMTS operation specified operation in the following bands: GSM 900/2100MHz
- » The characteristic impedance on any antenna or cable assembly attached to this modem should be 50 ohms
- » The antenna must be capable of handling a minimum of 2W output power
- » The VSWR should be less than 3:1 to avoid damage to the modem

GSM Antenna

The GSM antennas we recommend to use for the ZEST series is the Mike 1A SMA male magnetic mount antenna and the Delta 1A SMA male stubby antenna, (Most other Siretta styles of GSM antennas are usable depending on customer preference). Please turn to **page 38** for ordering details for the Mike 1A, alternatively visit www.siretta.co.uk/mike1a-p-339.html for more information about this antenna. Please turn to **page 38** for ordering details for the Delta 1A, alternatively visit <http://www.siretta.co.uk/delta-gsmgprs-right-angle-stubby-antenna-p-255.html> for more information about this antenna.

Figure 21. Mike 1A GSM antenna



Figure 22. Delta 1A GSM antenna



Power

ZEST USB Power Connector

The mini USB type B connector is provided for power connection to the modem. the current/voltage output of the USB interface can reach at least 1A/5V. Pins on this connector are shown in **table 7** below.

Figure 23. ZEST-GPRS USB Connector

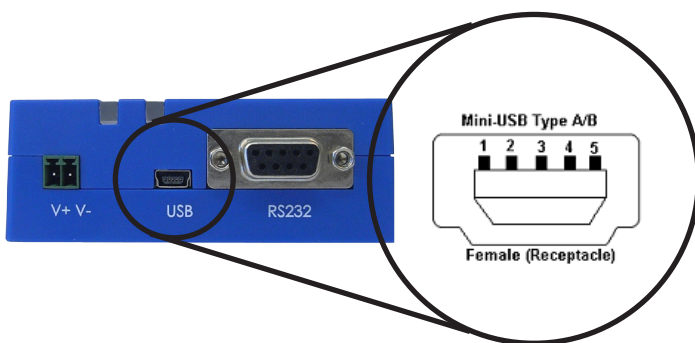

Table 7. Mini USB Connectors

Pin	Name	Direction	Description	Low Level	Nominal	High Level
1	VBUS	Input	USB Power VBUS	4.75V	5V	5.25V
2	-	-	-	-	-	-
3	-	-	-	-	-	-
4	-	-	-	-	-	-
5	GND	Input	Signal Ground	-	0V	-

Power Connector (2-pin 3.5mm Pluggable Terminal Block)

A 2-pin 3.5mm pluggable terminal block is used for supplying DC power to the modem.

Figure 24. Terminal block power connector

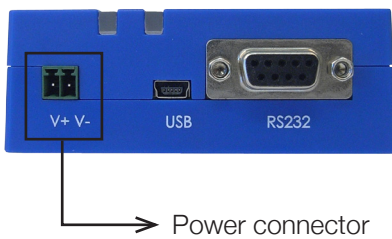

Figure 25. Pin numbering

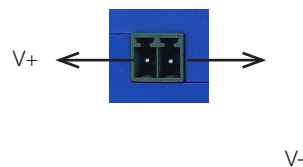

Table 8. ZEST-N-GPRS (EU) in usage

Pin	Name	Direction	Description	Low Level	Nominal	High Level
1	Vin	Input	Input power	6V	12V	18V
2	GND	Input	Signal ground	-	0V	-

Table 9. ZEST-N-UMTS (EU) in usage

Pin	Name	Direction	Description	Low Level	Nominal	High Level
1	Vin	Input	Input power	6V	12V	21V
2	GND	Input	Signal ground	-	0V	-

The modem ON/OFF state is activated by applying power to the power inputs.

Power Supply Requirements

A DC power supply must be connected to the power input.

Table 10. Characteristics of power input

	ZEST GPRS	ZEST UMTS
DC input voltage	6 to 18V	6 - 21V
Recommended input voltage	12V DC	12V DC
Supply current @ 12V:		
Peak (20ms at registration)	2A	2A
Average standby	25mA	25mA
Call in progress	250mA	250mA
Ringing	250mA	250mA

The ZEST modem has a wide operating voltage and can be powered from 6V to 26V (depending on ZEST version). Powering the modem can be done via:

- » Modem Power Supply - Standard multi region power supply provides constant 12V at 2A (see overpage)

The ZEST modem has the following input power supply protection:

- » On board voltage reverse polarity protection
- » Over voltage spike protection to 70V for 1mS.
- » ESD protection to +/-4KV contact discharge and +/-8KV air discharge.

NOTE - The current requirements of the ZEST modem will scale with input voltage. The higher the input voltage the lower the current consumption, the power consumption will remain constant. Recommended input voltage is 12V.

Table 11. ZEST modem states

ZEST	Pin-4 (ON)	Pin-3 (OFF)	Modem ON/OFF
OFF	ACTIVE	ACTIVE	OFF
ON	ACTIVE	ACTIVE	ON
ON	NOT-ACTIVE	ACTIVE	Switches OFF
OFF	NOT-ACTIVE	ACTIVE	OFF
OFF	ACTIVE	NOT-ACTIVE	Switches ON
ON	ACTIVE	NOT-ACTIVE	ON

Modem Power Supply

The Siretta power supply for the range of modems provides an industry standard output which is compatible across the range of Siretta modems. With a stable 12V output voltage, the Modem PSU offers a wide input voltage as well as being highly efficient. Please turn to [page 38](#) for ordering details.

Figure 26. Siretta Modem PSU



Current Consumption

The measurement was taken with 2 Voltages (5V, 12V).

The modem was connected via RS232 to a PC in order to send/receive AT commands. The temperature was maintained in a temperature chamber. The voice call with power level 5 in GSM 900 was established with a GSM signal generator test set.

Table 12. ZEST modem current consumption

	5V	12V
Modem switched off	0.01 mA	0.67 mA
On, network connection (Idle mode)	71 mA	25 mA
On, network connection voice call (power level 5) GSM 900	235 mA	98 mA

Table 13. ZEST module current consumption

Function	State	Current
Modem on (Not registered)	Idle	39mA
Modem on (Registered)	Idle	36mA
Modem on (Registered with IP address)	Idle	40mA
Modem on (Registered with socket connected)	Idle	41mA
Modem On (Registered with socket connected) - Peak	Transmitting	109mA
Modem on (Registered with socket connected) - Average	Transmitting	98mA

Switching the Modem ON/OFF

Power on the ZEST

The ZEST modems are designed to auto power up using a built in power controller. This process is controlled by default within the modem to control the module functionality and allows for automatic power up when power is supplied. The auto power on control will automatically power up the modem as required and manage its status whilst it is online.

NOTE - The modem is fully operational after it has powered on and able to send AT commands. This may take anything from 2 to 6 seconds depending on the startup procedure. Once the modem is powered up it will automatically attempt to logon to the GSM network and may take anything from 10 seconds to 4 minutes depending on the network. This is outside the control of the modem and is network and frequency dependant.

Power off the ZEST

The ZEST modems have several options to power off. The 2 main options are shown below:

- 1) Manually power down the modem using the AT command AT#SHDN. This command will safely disconnect from the network and power down the module.
- 2) Manually power down the modem removing power from the input power supply on the 3.5mm power connector. When power is removed the modem will power off.

NOTE - This process does not safely disconnect from the network and immediately powers down the modem. If used continuously you may find that the network will block the modem IMEI and prevent network access.

Considerations when manually powering the ZEST on and off

The power supply required to successfully power the ZEST should provide a fast, positive transition from 0V (GND) up to Vcc (max 18V GPRS version, max 21V UMTS version), or at least a large fraction of that voltage range (>6V). Very slow transitions (significantly slower than many milliseconds) or very small transitions (e.g. only a few millivolts instead of 6V to 18V GPRS version, 6V to 21V UMTS version) will not turn on the modem (since they are not considered to be a “positive edge”).

Although this will not be an issue in almost all typical applications of the modem, under the following condition special design care has to be taken:
Large capacitors in your power supply which will lead to slow leading and falling edges

The case above might prevent the modem from recognizing the power-up signal. This is no failure of the modem itself, the same would apply to almost any electronic device that provides a separate “power-on” signal.

If you are in doubt, please use the following recommendations:

- » Use the Vcc power supply signal from the main supply to test the power on signal function..
- » Make sure that your signal and system design adheres to the recommendations mentioned above.
- » Consult our support team and we will be more than happy to assist you.

Disaster recovery power down reset procedure

The ZEST modems can be powered off in the event of disaster recovery and modem system failures.

This procedure should only be used in the event of the standard power down function using the software shutdown AT command failing to operate correctly.

NOTE - Misuse of this function causes the modem to detach abruptly from the GSM network and may cause the modem to become blacklisted.

Embedded Software Support

When developing your application you may decide to use an external micro controller to manage your applications functionality. Depending on your exact requirements you may need to have the added flexibility of using an external microprocessor to manage power constraints or enable high performance functionality. If you do not have very specific requirements then you may have the option to use the embedded software package included within the GSM/UMTS engine. All the modules used within the ZEST modems support 2 embedded software platforms which are available for use and can be chosen to suit your exact design requirements.

The available platforms for the ZEST modem are shown below:

- » Telit AppZone
- » Telit Easy Script in Python

NOTE - Contact your Siretta representative for information about these 2 programming environments.

Telit AppZone

Telit AppZone is a high-level optimized standard C development environment that has been developed as an integrated platform to run within the GSM module and provides an advantageous “all-in-one” solution. This allows you to save time and money because the M2M module can perform all the key tasks normally associated with an external microprocessor.

The development environment offers a flexible platform whether you are planning on developing a new tracking application, an innovative healthcare device, a trend-setting Automatic Meter Reading component or any other M2M application. The Telit AppZone could meet your needs whilst minimizing your development effort and design costs. The end result is a much faster TTM (Time to Market).

Some of the key distinguishing features of AppZone include:

- » Fast Interrupt Latency (130µsec)
- » AT command tunneling
- » Multi-tasking with IPC feature and application priority
- » Over-The-Air (OTA) updates
- » Low power consumption (Deep Sleep mode 75µA)
- » File System and memory (FS NVM, Flash and RAM)

Telit Easy Script in Python

Telit Easy Script in Python is a high-level Python programming language script interpreter. Python is often characterized as minimalist, although this applies mainly to the language's core syntax and semantics. The standard library provided within the development environment offers a large number of additional extensions to perform many complex tasks to enable fast application development.



The ZEST modems offer the Python script interpreter engine with around 3MB of nonvolatile memory for the user application scripts and data storage. There is an additional 1.2MB of RAM reserved for Python engine usage and integrated TCP/IP stack. There are many benefits of the Python programming language and it is already being used in a wide variety of applications.

Some of the key distinguishing features of Python include:

- » Extremely clear, readable syntax
- » Strong introspection capabilities
- » Intuitive object orientation
- » Natural expression of procedural code
- » Full modularity, supporting hierarchical packages
- » Exception-based error handling
- » High level dynamic data types
- » Extensive standard libraries and third party modules

Siretta Recommends

All ZEST series modems will require extra product which are all available from Siretta. Below are some of the products we recommend for your modem:

Product	Part No.	Description
Interface Cables		
RS232 Male to Female Cable	29284	The RS232 serial cable is the standard cable used for connecting the ZEST modem to other devices such as a PC or industrial control equipment. The RS232 serial cable allows a serial connection to the modem which you can use to setup and change the modem configuration as well as providing a communication channel for connected equipment over the GSM/UMTS network.
		29284 - Cable length: 1m
USB to RS232 Male Cable	29891	The USB to RS232 Male serial cable allows a serial connection to the modem via USB which you can use to setup and change the modem configuration as well as providing a communication channel for connected equipment over the GSM/UMTS network.
		29891 - Cable length: 1.5m
USB to Mini USB Cable	31578	The USB to Mini USB cable allows you to connect to the ZEST-UMTS modem via the standard USB port. The Mini USB cable connects the modem to other devices such as a PC or industrial control equipment. The USB to Mini USB serial cable allows a serial connection to the modem via USB which you can use to setup and change the modem configuration as well as providing a communication channel for connected equipment over the GSM/UMTS network.
		31578 - Cable length: 500mm

Antennas

Mike 1A



**33529 /
33530**

The Mike 1A is a versatile ¼ wave magnetic mount antenna, and is very popular being used by many users of GSM / GPRS and 3G equipment. Of rigid construction with a unity gain whip, the magnetic mount base ensures a solid connection to metallic surfaces.

33529 - Cable length: 1.2m
Connector: SMA Male

33530 - Cable length: 2.5m
Connector: SMA Male

Delta 1A



34368

The Delta 1A is a direct connect, stubby antenna tuned to the quad band GSM / GPRS and 3G frequencies and built with a straight connector. Despite its small size of 56mm in length, it still performs at a high level that most stubby antennas cannot compete with.

The Delta 1A offers a small and compact, cable-free antenna solution that is ideal for use with wireless modems within the M2M industry.

Power

Siretta Modem PSU



34677

The Siretta power supply for the range of modems provides an industry standard output which is compatible across the range of Siretta modems. With a stable 12V output voltage, the Modem PSU offers a wide input voltage as well as being highly efficient.

32889 - Cable length: 1m

Installation

Considerations for Installations Incorporating the ZEST

There are several conditions which need to be taken into consideration when designing your application as they might affect the modem and its functionality. These are:

Environmental conditions: The modem must be installed so that the environmental conditions stated such as temperature, humidity and vibration are satisfied. Additionally, the electrical specifications must not be exceeded.

GSM signal strength: The modem/antenna has to be placed in a position that ensures sufficient GSM signal strength. To improve signal strength, the antenna can be moved to a more elevated position. Signal strength usually depends on how close the modem is to GSM base station. You must ensure that the location at which you intend to use the modem is within the network coverage area. Degradation in signal strength can be the result of a disturbance from another source, for example an electronic device in the immediate vicinity.

Please see the SNYPER range of signal strength testers at www.siretta.co.uk

When the application is operational, you can verify signal strength by issuing the AT command:

AT+CSQ

See “AT+CSQ Signal Strength” in the AT command manual

*Tip: Before installing the modem you can use an ordinary mobile telephone to check the signal strength in each possible installation location. Siretta can also provide a GSM signal tester which provides a full breakdown of the GSM signal received.**

When considering the location for the modem and antenna placement, you must consider received signal strength as well as cable length as long cable runs can attenuate the received signal strength.

Connections of components to ZEST Series modems: The system integrator is responsible for the final system solution. If external components are incorrectly designed or installed it may cause radiation limits to be exceeded. For instance, improper cable connections or incorrectly installed antennas can disturb the network and lead to modem malfunction.

*Please contact your Siretta representative for more information

Network and subscription: Before your application is used, you must ensure that your chosen network provides the necessary telecommunication services. Contact your service provider to obtain the necessary information.

- » If you intend to use SMS in the application, ensure this is included in your subscription.
- » Consider the choice of the supplementary services such as GPRS and CSD.

Power Supply Installation

- » Use a high-quality power supply with short leads. This ensures that the voltages at the connector pins are within the specified range, especially during the maximum peak current of approximately 2A.
- » When the modem is powered from a battery or a high current supply, connect a fast 1.25A fuse in line with the positive supply. This protects the power cabling and modem from damage.

Securing the Modem

Before securing the modem please take into account the amount of additional space required for the mating connectors and cables that will be used with the modem in the application.

- » Where access is restricted, it may be easier to connect all the cables to the modem prior to placing it in the application on the headers.
- » Securely attach the ZEST series modem to the host application using 2 M3 3mm diameter pan-head screws or use DIN rail mount.

Safety and Product Care

Please read the information on this page and **page 40** 'Installation' before you begin your system integration.

General Precautions

- » The ZEST series modems are a standalone item designed for indoor use only. For use outside it must be installed in a weatherproof enclosure.
- » Do not exceed the environmental and electrical limits as specified.
- » Avoid exposing the modem to lit cigarettes, naked flames or to extreme hot or cold temperatures.
- » Never try to dismantle the modem. There are no components inside the modem that can be serviced by the user. If you attempt to dismantle the modem, you will invalidate the warranty.
- » The ZEST series modems must not be installed or located where the surface temperature of the enclosure may exceed 85°C.
- » All cables connected to the ZEST series modems must be secured or clamped, immediately adjacent to the modems connectors, to provide strain relief and to avoid transmitting excessive vibration to the modem in the installation.
- » To protect power supply and to meet the fire safety requirements when the modem is powered from a battery or a high current supply, connect a fast 1.25A fuse in line with the positive supply.
- » Do not connect any incompatible component or product to the ZEST series modem.

SIM Card Precautions

Before handling the SIM card in your application, ensure that you have discharged any static electricity. Use standard precautions to avoid electrostatic discharges.

- » When designing a ZEST series modem into your application, the accessibility of the SIM card should be taken into account so that it can be removed or changed.
- » We always recommend that you have the SIM card protected by a PIN code. This will ensure that the SIM card cannot be used by an unauthorized person.

Antenna Precautions

If the antenna is to be mounted outside, always consider the risk of a lightning strike. Follow the instructions provided by the antenna manufacturer. In addition please observe the following:

- » Never connect more than one modem to a single antenna. The modem can be damaged by radio frequency energy from the transmitter of another modem.
- » With all mobile station equipment, the antenna of the modem emits radio frequency energy. To avoid EMI (electromagnetic interference) you must determine if the application or equipment in the application's proximity, needs further protection against radio emission and the disturbances it might cause. Protection is secured either by shielding the surrounding electronics or by moving the antenna away from the electronics and external signal cables.
- » The modem and antenna may be damaged if either come into contact with ground potentials other than the ground potential used in your application. Beware, ground potentials can vary significantly between hardware platforms.

Exposure to RF Energy

There has been some public concern about possible health effects of using GSM equipment in close proximity to a person or body. Although research on health effects from RF energy has focused for many years on the current RF technology, research has begun on new radio technologies, such as GSM and UMTS. After existing research had been reviewed, and after compliance to all applicable safety standards has been tested, it has been concluded that the ZEST series modem is fit for use.

If you are concerned about exposure to RF energy, there are a number of things you can do to minimize exposure. Obviously, limiting the duration of time near a device will reduce your exposure to RF energy. In addition, you can reduce RF exposure by operating your modem efficiently by adhering to the following guidelines:

Electronic devices: Most electronic equipment, for example in hospitals and motor vehicles is shielded from RF energy. However, RF energy may affect some malfunctioning or improperly shielded electronic equipment.

Vehicle electronic equipment: Check your vehicle manufacturer's representative to determine if any on board electronic equipment is adequately shielded from external RF energy.

Medical electronic equipment: Consult the manufacturer of any personal medical devices (such as pacemakers, hearing aids, etc.) to determine if they are adequately shielded from external RF energy.

Turn your modem OFF in health care facilities when any regulations posted in the area instruct you to do so. Hospitals or health care facilities may be using RF monitoring equipment.

Aircraft: Turn your modem OFF before boarding any aircraft. To prevent possible interference with aircraft systems, Federal Aviation Administration (FAA) regulations require you to have permission from a crewmember to use your modem equipment whilst the plane is on the ground. To prevent interference with cellular systems, local RF regulations prohibit using your modem whilst in the air.

Blasting areas: To avoid interfering with blasting operations, turn your modem OFF when in a "blasting area" or in areas posted: "turn off two-way radio". Construction crew often uses remote control RF devices to set off explosives.

Potentially explosive atmospheres: Turn your modem OFF when in any area with a potentially explosive atmosphere. It is rare, but your modems or their accessories could generate sparks. Sparks in such areas could cause an explosion or fire resulting in bodily injury or even death.

Areas with a potentially explosive atmosphere are often, but not always, clearly marked. They include fuelling areas such as petrol stations, below deck on boats, fuel or chemical transfer or storage facilities and areas where the air contains chemicals or particles, such as grain, dust or metal powders. Do not transport or store flammable gas, liquid or explosives, in the compartment of your vehicle, which contains your modem or accessories. Before using your modem in a vehicle powered by liquefied petroleum gas (such as propane or butane) ensure that the vehicle complies with the relevant fire and safety regulations of the country in which the vehicle is to be used.

Safety Recommendations

PLEASE READ CAREFULLY

Be sure the use of this product is allowed in the country intended and the environment required. The use of this product may be dangerous and has to be used with caution in the following areas:

- » Where it can interfere with other electronic devices in environments such as hospitals, airports, aircrafts, etc
- » Where there is risk of explosion such as gasoline stations, oil refineries, gas works etc

It is responsibility of the user to enforce the country regulation and the specific environment regulation.

Do not disassemble the product, any mark of tampering will compromise the warranty.

We recommend following the instructions of this hardware user guide for the correct wiring of the product. The product has to be supplied with a stabilized voltage source and the wiring has to conform to the security and fire prevention regulations.

The product has to be handled with care, avoid any direct contact with the pins because electrostatic discharge may damage the product. The same precautions have to be observed for the SIM card installation. Do not insert or remove the SIM when the product is in power saving mode. (AT+CFUN=5).

The system integrator is responsible for the complete functionality of the final product. Therefore, care has to be taken with the external components used with the module, as well as any installation issue.

Should there be any doubt, please refer to the technical documentation and the regulations in force. Every module has to be equipped with a suitable antenna with characteristics which match the product requirements.

The antenna has to be installed with care in order to avoid any interference with other electronic devices and has to guarantee a minimum distance from the body (20 cm). In case this requirement cannot be satisfied, the system integrator has to assess the final product against the SAR regulation EN 50360.

Conformity Assessment

The ZEST series of modems conform to the R&TTE Directive for use as a stand-alone product. If the modem is installed in compliance with the telecoms installation instructions then no further evaluation is required under Article 3.2 of the R&TTE Directive and no further involvement of an R&TTE Directive Notified Body is required for the final application.

The ZEST series of modems conform to the following European Union Directives:

- » R&TTE Directive 1999/5/EC (Radio Equipment & Telecommunications Terminal Equipment)
- » LVD (Low Voltage Directive) 73/23/EEC and product safety
- » Directive 89/336/EEC for conformity for EMC

In order to satisfy the essential requisite of the R&TTE 99/5/EC directive, the ZEST series modems are compliant with the following standards:

- » GSM (Radio Spectrum). Standard: EN 301 511 and 3GPP 51.010-1
- » EMC (Electromagnetic Compatibility). Standards: EN 301 489-1 and EN 301 489-7
- » Include stand-alone spurious emissions to Clause 8.2 of EN 301 489-1.
- » LVD (Low Voltage Directive) Standards: EN 60 950

Disclaimer

The information contained in this document is proprietary to Siretta. Siretta has made every effort to ensure that the accuracy of the information contained within this document is accurate. Siretta does not make any warranty as to the information contained within this document and does not accept any liability for any injury, loss or damage of any kind incurred by the use of this information.

Siretta does not take responsibility for any application developed using the modem characterized in this document and notes that any application of this modem must comply with the safety standards of the applicable country and comply with the relevant wiring rules. Siretta reserves the right to make modifications, additions and deletions to this document due to typographical errors, inaccurate information, or improvements to equipment at any time and without notice. Such changes will be incorporated into new editions of this document.

All rights reserved.

© 2017 Siretta Ltd

Definitions

Term	Definition
2G	2nd Generation Mobile Telecommunications
3G	3rd Generation Mobile Telecommunications
AMR	Automatic Meter Reading
AT	Attention
CBS	Cell Broadcasting Service
CSD	Circuit Switched Data
CTS	Clear to Send
DC	Direct Current
ESD	Electrostatic Discharge
GND	Ground
GPIO	General Purpose Input Output
GPRS	General Packet Radio Service
GPS	Global Positioning System
GSM	Global System for Mobile Communications
LED	Light Emitting Diode
M2M	Machine to Machine
RI	Ring Indicator
RS232	Radio Sector 232
RS485	Radio Sector 485
RTS	Request to Send
RXD	Receive Signal
SIM	Subscriber Identity Module
SMA	Sub Miniature Version A
SMS	Short Message Service
TCP/IP	Internet Protocol Suite
TXD	Transmit Signal
UART	Universal Asynchronous Receiver/Transmitter
UMTS	Universal Mobile Telecommunications System (Same as 3G)
USB	Universal Serial Bus
VBUS	Virtual BUS
Vcc	Power supply pin
Vin	Input voltage
VSWR	Voltage Standing Wave Ratio



sales +44 (0)118 976 9014
fax +44 (0)118 976 9020
accounts +44 (0)118 976 9069
email sales@siretta.co.uk

www.siretta.co.uk

Siretta Ltd
Basingstoke Road
Spencers Wood
Reading
Berkshire
RG7 1PW
United Kingdom

Company No. 08405712
VAT Registration No. GB163 04 0349

A member of the Olanca Group Ltd



Rev 1.9 - April 2017