

1-A Linear Li-Ion/Polymer Battery Charger with 28V Over-Voltage Protection

General Description

The AAT3783 BatteryManager™ is a single-cell Lithium-Ion (Li-Ion)/Li-Polymer battery charger IC, designed to operate from USB ports, AC adapter inputs, or from a charger adapter up to an input voltage of 6.5V. For increased safety, the AAT3783 also includes over-voltage input protection (OVP) up to 28V.

The AAT3783 precisely regulates battery charge voltage and current for 4.2V Li-Ion/Polymer battery cells through an extremely low $R_{DS(ON)}$ switch. When charged from an adapter or a USB port, the battery charging current can be set by an external resistor up to 1A. In the case of an over-voltage condition in excess of 6.5V, a series switch opens preventing damage to the battery and charging circuitry. With the addition of an external resistor the OVP trip point can be programmed to a level other than the factory set value of 6.5V. In the case of an OVP condition a fault flag is activated.

Battery charge state is continuously monitored for fault conditions. In the event of an over-current, battery over-voltage, short-circuit or over-temperature failure, the device will automatically shut down, thus protecting the charging device, control system and the battery under charge. A status monitor output pin is provided to indicate the battery charge status by directly driving an external LED. An open-drain power-source detection output (ADPP) is provided to report the power supply status.

The AAT3783 comes in a thermally enhanced, space-saving, Pb-free 16-pin 3x4 mm TDFN package and is specified for operation over the -40°C to $+85^{\circ}\text{C}$ temperature range.

Features

- USB or AC Adapter System Power Charger
- Programmable from 100mA to 1A Max
- 4.0V ~ 7.5V Input Voltage Range
 - Over-Voltage Input Protection up to 28V
- High Level of Integration with Internal:
 - Charging Device
 - Reverse Blocking Diode
 - Current Sensing
- Digital Thermal Regulation
- Charge Current Programming (ISET)
- Charge Termination Current Programming (TERM)
- Charge Timer (CT)
- Battery Temperature Sensing (TS)
- TS Pin Open Detection
- Automatic Recharge Sequencing
- No Trickle Charge Option Available
- Full Battery Charge Auto Turn Off / Sleep State / Charge Termination
- Automatic Trickle Charge for Battery Pre-conditioning
- Battery Over-Voltage and Over-Current Protection
- Emergency Thermal Protection
- Power On Reset
- 16-pin 3x4mm TDFN Package

Applications

- Bluetooth™ Headsets, Headphones, Accessories
- Digital Still Cameras
- Mobile Phones
- MP3 Players
- Personal Data Assistants (PDAs)
- Other Li-Ion/Polymer Battery Powered Devices

Typical Application

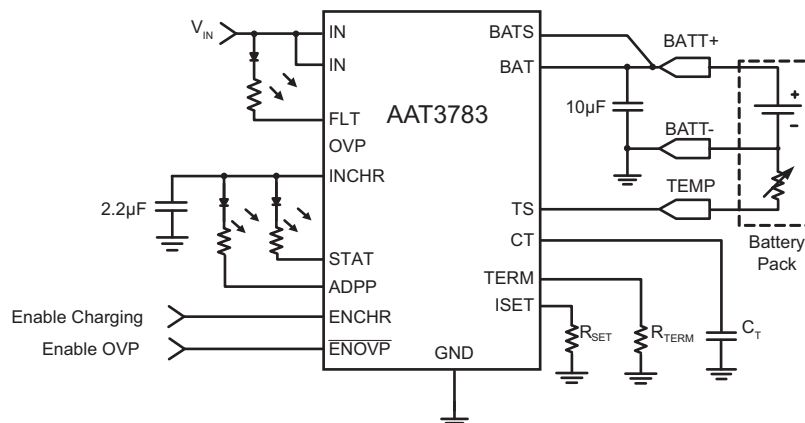

AAT3783

I-A Linear Li-Ion/Polymer Battery Charger with 28V Over-Voltage Protection

Pin Descriptions

Pin Number	Name	Type	Function
1	INCHR	I/O	Internal connection between the output of the OVP stage and the input of the battery charger. Decouple with 2.2μF capacitor.
2	BATS	I	Battery sense pin. Connect directly to the battery's + terminal. If not used, BATS must be connected to BAT.
3	BAT	O	Connect to Lithium-Ion battery.
4	TS	I/O	Battery temperature sense pin.
5	ENOVV	I	Active low enable for OVP stage.
6	OVP	I	Over-voltage protection threshold pin. Leave open for the default 6.5V setting; connect to a resistor to adjust the OVP setting (see Application Information).
7	FLT	O	Over-voltage fault flag, open drain.
8	STAT	O	Charge status pin, open drain.
9	ADPP	O	Input power-good (USB port/adaptor present indicator) pin, open-drain.
10	CT	I	Charge timer programming input pin (no timer if grounded).
11	ENCHR	I	Active high enable pin (with internal pull-down) for charging circuitry.
12	TERM	I	Charge termination current programming input pin (internal default 10% termination current if TERM is open).
13	GND	I/O	Connect to power ground.
14	ISET	I	Charge current programming input pin.
15, 16	IN	I	Input from USB port/ adapter connector.

Pin Configuration

**TDFN34-16
(Top View)**

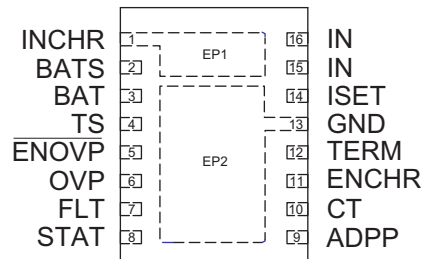

I-A Linear Li-Ion/Polymer Battery Charger with 28V Over-Voltage Protection**Absolute Maximum Ratings¹**

Symbol	Description	Value	Units
V_{IN}	IN continuous	30	V
V_{INCHR}	Charger IN continuous	-0.3 to 7.5	
V_{FLT}	Fault flag continuous	-0.3 to +30	
V_N	BAT, STAT, ADPP, EN, ISET, TS, ENOVP, OVP	-0.3 to $V_{INCHR} + 0.3$	
T_J	Operating Junction Temperature Range	-40 to 150	°C
T_{LEAD}	Maximum Soldering Temperature (at Leads)	300	

Thermal Information²

Symbol	Description	Value	Units
θ_{JA}	Maximum Thermal Resistance (TDFN 3x4)	50	°C/W
P_D	Maximum Power Dissipation	2	W

1. Stresses above those listed in Absolute Maximum Ratings may cause permanent damage to the device. Functional operation at conditions other than the operating conditions specified is not implied. Only one Absolute Maximum Rating should be applied at any one time.
2. Mounted on a FR4 board.

DATA SHEET

AAT3783

I-A Linear Li-Ion/Polymer Battery Charger with 28V Over-Voltage Protection

Electrical Characteristics¹

$V_{IN} = 5V$, $T_A = -40^\circ C$ to $+85^\circ C$; unless otherwise noted, typical values are at $T_A = 25^\circ C$.

Symbol	Description	Conditions	Min	Typ	Max	Units
Operation						
V_{IN_MAX}	Input Over-Voltage Protection Range				28	V
V_{IN}	Normal Operating Input Voltage Range		4.0		7.5	V
Over-Voltage Protection						
V_{UVLO}	Under-Voltage Lockout Threshold	Rising Edge		3		V
	UVLO Hysteresis			60		mV
I_Q	Operating Quiescent Current	$V_{IN} = 5V$, $\overline{ENOV\overline{P}} = 0V$, $I_{OUT} = 0$, $ENCHG = 0V$		30	50	μA
$I_{SD(OFF)}$	Shutdown Supply Current	$\overline{ENOV\overline{P}} = V_{IN} = 5.5V$, $V_{OUT} = 0V$, $ENCHG = 0V$		4	8	μA
V_{OVPT}	Over-Voltage Protection Trip Voltage	Rising Edge, OVP = Not Connected		6.5		V
Battery Charger						
V_{UVLO}	Under-Voltage Lockout Threshold	Rising Edge	3		4	V
	UVLO Hysteresis			150		mV
V_{ADPP_TH}	Adapter Present Indicator Threshold Voltage, $V_{IN} - V_{BAT}$	$V_{IN} > V_{UVLO}$		60	150	mV
I_{OP}	Operating Current	Charge Current = 100mA, $\overline{ENOV\overline{P}} = 0V$, $ENCHG = V_{IN}$		0.5	1	mA
$I_{SHUTDOWN}$	Shutdown Mode Current	$V_{BAT} = 4.25V$, $\overline{ENOV\overline{P}} = ENCHG = 0V^2$		0.4	1	μA
I_{BAT}	Leakage Current from BAT Pin	$V_{BAT} = 4V$, $\overline{ENOV\overline{P}} = V_{IN}$		0.4	2	μA
Voltage Regulation						
V_{BAT_EOC}	Output Charge Voltage Regulation		4.158	4.20	4.242	V
$\Delta V_{CH}/V_{CH}$	Output Charge Voltage Tolerance			0.5		%
V_{MIN}	Preconditioning Voltage Threshold	(Option available for no trickle charge)	2.5	2.6	2.7	V
V_{RCH}	Battery Recharge Voltage Threshold			$V_{BAT_EOC} - 0.1$		V
Current Regulation						
I_{CC_RANGE}	Charge Current Programmable Range		100		1000	mA
I_{CH_CC}	Constant-Current Mode Charge Current	$V_{BAT} = 3.6V$	-10		10	%
V_{ISET}	ISET Pin Voltage			2		V
K_{ISET}	Charge Current Set Factor: I_{CH_CC}/I_{ISET}	Constant Current Mode, $V_{BAT} = 3.6V$		800		
V_{TERM}	TERM Pin Voltage	$R_{TERM} = 13.3k\Omega$		0.2		V
I_{CH_TRK}	Trickle Charge Current		5	10	15	% I_{CH_CC}
I_{CH_TERM}	Charge Termination Threshold Current	TERM Pin Open	5	10	15	% I_{CH_CC}
		$R_{TERM} = 13.3 k\Omega$, $I_{CH_CC} \geq 800mA$	8	10	12	% I_{CH_CC}
Battery Charging Device						
$R_{DS(ON)}$	Total ON Resistance (IN to BAT)	$V_{IN} = 5V$, $I_{OUT} = 1A$		550		m Ω

- The AAT3783 is guaranteed to meet performance specifications over the $-40^\circ C$ to $+85^\circ C$ operating temperature range and is assured by design, characterization and correlation with statistical process controls.
- Current into charge.

DATA SHEET

AAT3783

I-A Linear Li-Ion/Polymer Battery Charger with 28V Over-Voltage Protection

Electrical Characteristics¹

$V_{IN} = 5V$, $T_A = -40^{\circ}C$ to $+85^{\circ}C$; unless otherwise noted, typical values are at $T_A = 25^{\circ}C$.

Symbol	Description	Conditions	Min	Typ	Max	Units
Logic Control						
$V_{EN(H)}$	Input High Threshold		1.6			V
$V_{EN(L)}$	Input Low Threshold				0.4	V
V_{STAT}	Output Low Voltage	STAT Pin Sinks 4mA			0.4	V
I_{STAT}	STAT Pin Current Sink Capability				8	mA
V_{ADPP}	Output Low Voltage	ADPP Pin Sinks 4mA			0.4	V
I_{ADPP}	ADPP Pin Current Sink Capability				8	mA
V_{FLT}	Output Low Voltage	FLT Pin Sinks 1mA			0.4	V
I_{FLT}	FLT Pin Current Sink Capability				5	mA
T_{BLK_FLT}	FLT Blanking Time	From De-assertion of OV	5	10	15	ms
T_{D_FLT}	FLT Assertion Delay Time from Over-Voltage	From Assertion of OV		1		μs
T_{RESP_OV}	Over-Voltage Response Time	V_{IN} Rise to 7V from 5V in 1ns		1		μs
T_{OVPON}	OVP Turn-On Delay Time	Charging current = 500mA, $C_{INCHR} = 1\mu F$		10		ms
T_{OVPR}	OVP Turn-On Rise Time	Charging current = 500mA, $C_{INCHR} = 1\mu F$		1		ms
T_{OVPOFF}	OVP Turn-Off Delay Time	Charging current = 500mA, $C_{INCHR} = 1\mu F$		6		μs
Battery Protection						
V_{BOVP}	Battery Over-Voltage Protection Threshold			4.4		V
I_{BOCP}	Battery Over-Current Protection Threshold			105		% I_{CH_CC}
TC	Trickle Plus Constant Current Mode Timeout	$C_{CT} = 100nF$, $V_{IN} = 5V$		3		Hour
TK	Trickle Timeout	$C_{CT} = 100nF$, $V_{IN} = 5V$		25		Minute
TV	Constant Voltage Mode Time Out	$C_{CT} = 100nF$, $V_{IN} = 5V$		3		Hour
I_{TS}	Current Source from TS Pin		69	75	81	μA
TS1	TS Hot Temperature Fault	Threshold	316	331	346	mV
		Hysteresis		25		
TS2	TS Cold Temperature Fault	Threshold	2.30	2.39	2.48	V
		Hysteresis		25		
T_{LOOP_IN}	Thermal Loop Entering Threshold			115		$^{\circ}C$
T_{LOOP_OUT}	Thermal Loop Exiting Threshold			85		$^{\circ}C$
T_{REG}	Thermal Loop Regulation			100		$^{\circ}C$
T_{SHDN}	Chip Thermal Shutdown Temperature	Threshold		140		$^{\circ}C$
		Hysteresis		15		

1. The AAT3783 is guaranteed to meet performance specifications over the $-40^{\circ}C$ to $+85^{\circ}C$ operating temperature range and is assured by design, characterization and correlation with statistical process controls.

I-A Linear Li-Ion/Polymer Battery Charger with 28V Over-Voltage Protection

Typical Characteristics

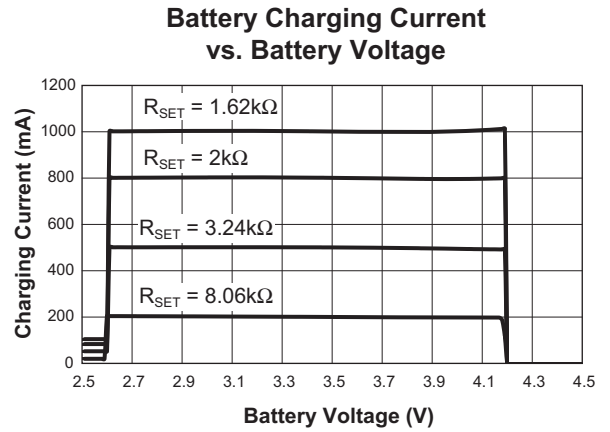
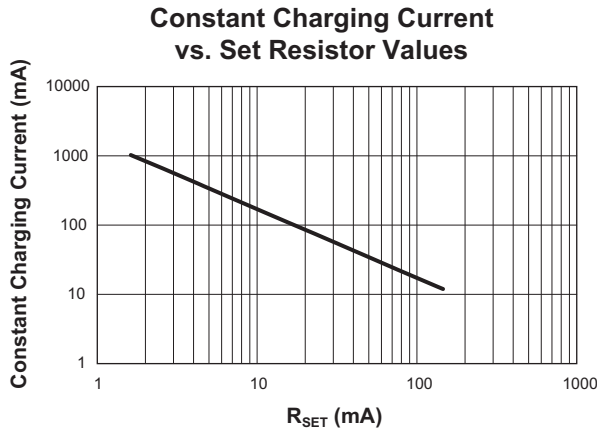

End of Charge Regulation Tolerance vs. Input Voltage
($V_{BAT_EOC} = 4.2V$)

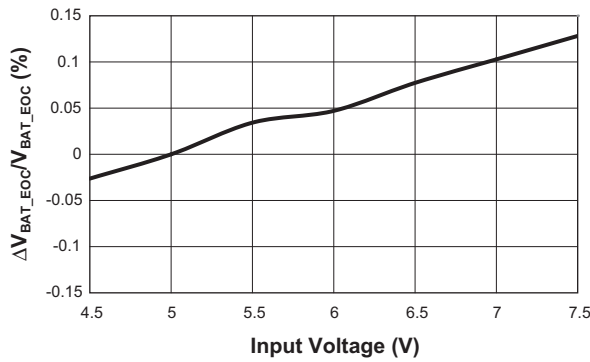

End of Charge Voltage vs. Temperature

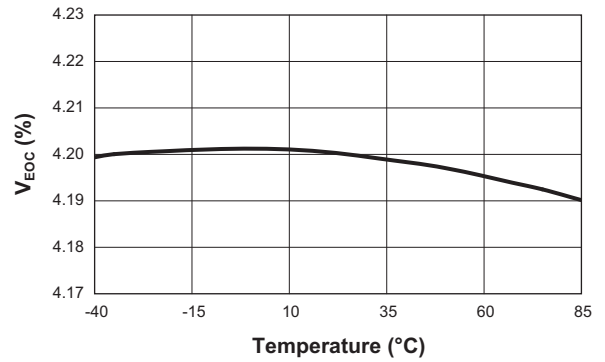

Battery Recharge Voltage Threshold vs. Temperature

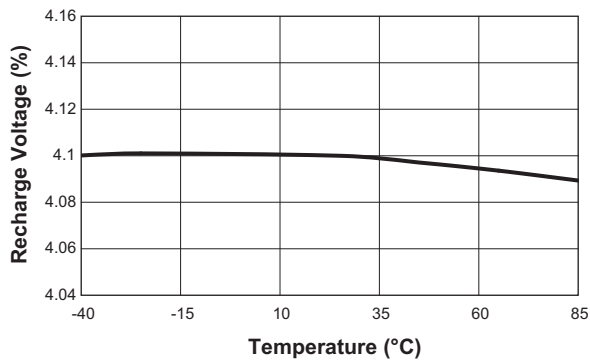

Preconditioning Charge Current vs. Input Voltage

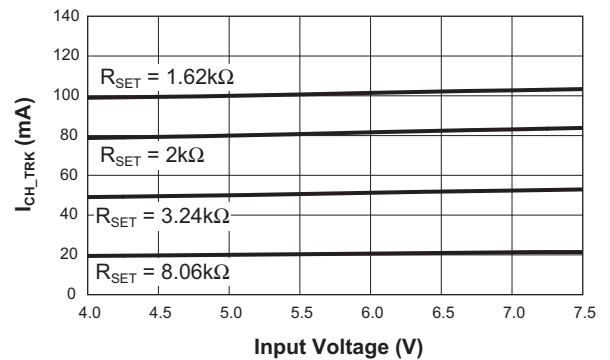

I-A Linear Li-Ion/Polymer Battery Charger with 28V Over-Voltage Protection

Typical Characteristics

Preconditioning Charge Current vs. Temperature
 ($R_{SET} = 8.06k\Omega$; $I_{CH_CC} = 200mA$)

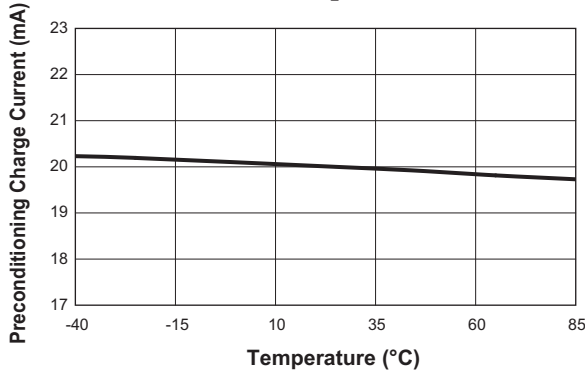

Preconditioning Voltage Threshold vs. Temperature

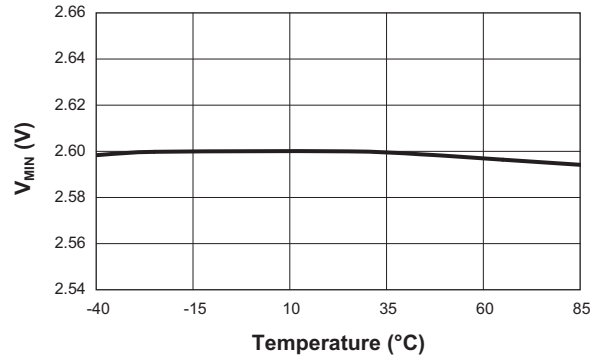

Constant Charging Current vs. Input Voltage
 ($R_{SET} = 1.62k\Omega$)

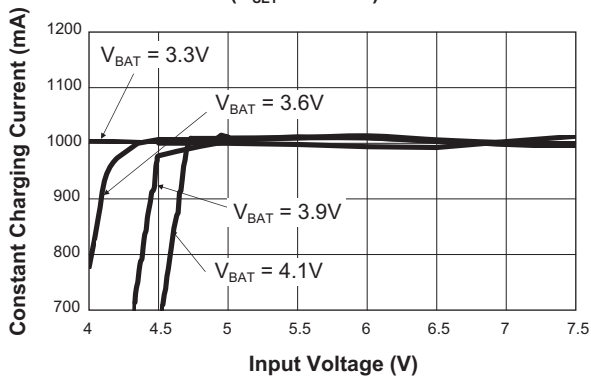

Total Resistance vs. Input Voltage
 (IN to BAT)

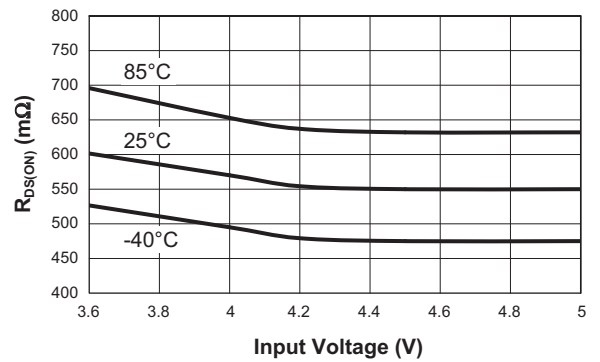

Temperature Sense Too Hot Threshold vs. Temperature

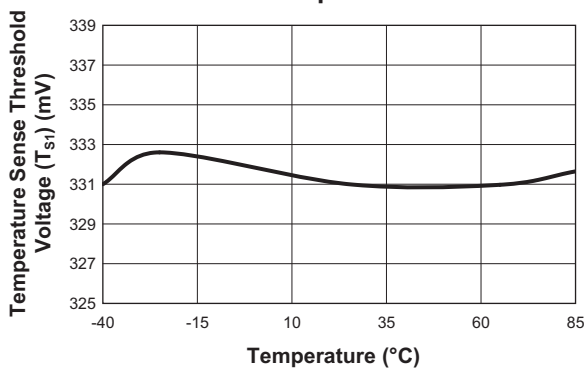

Temperature Sense Too Cold Threshold vs. Temperature

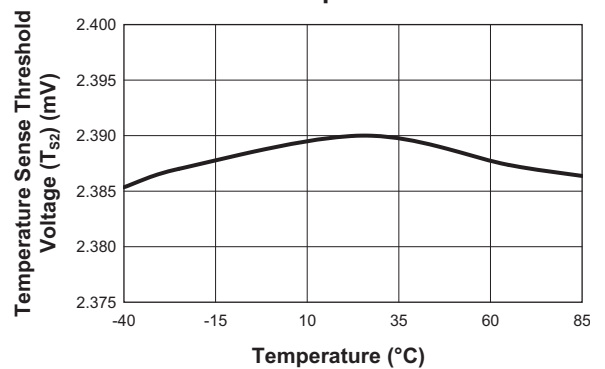

I-A Linear Li-Ion/Polymer Battery Charger with 28V Over-Voltage Protection

Typical Characteristics

Temperature Sense Output Current vs. Temperature

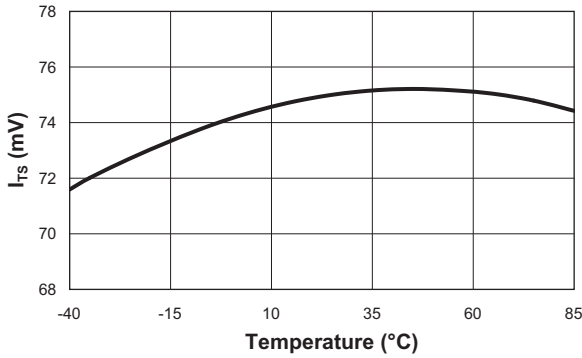

CT Pin Capacitance vs. Counter Timeout

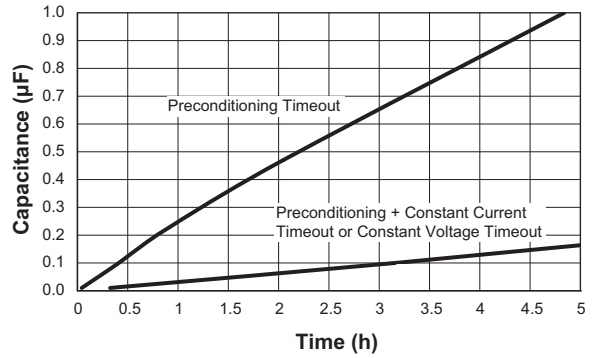

Operating Current vs. I_{SET} Resistor

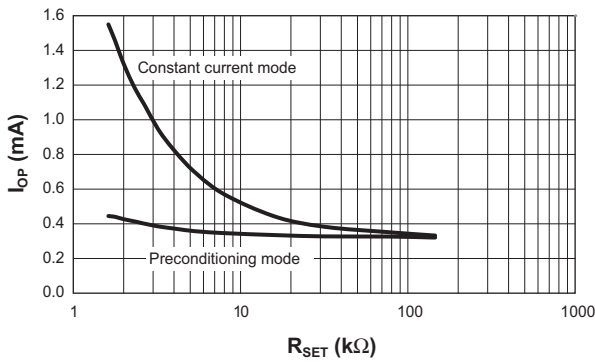

Termination Current to Constant Current Ratio vs. Termination Resistance

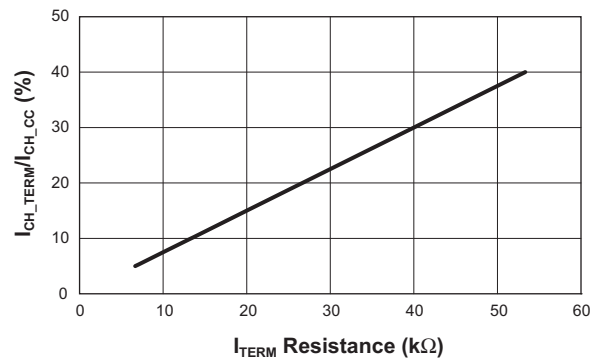

Input Low Threshold vs. Input Voltage

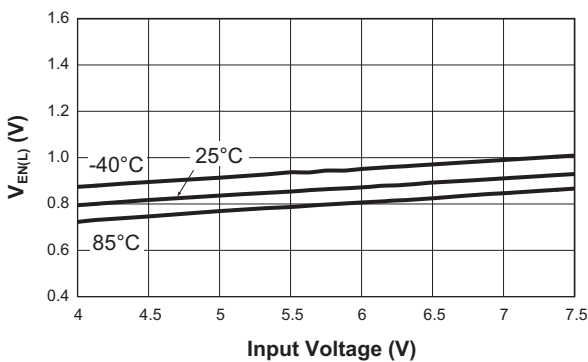

Input High Threshold vs. Input Voltage

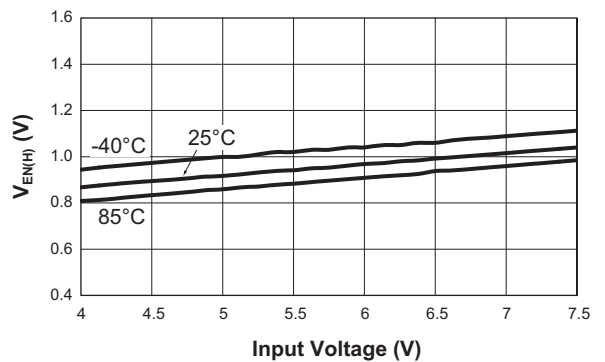

AAT3783

I-A Linear Li-Ion/Polymer Battery Charger with 28V Over-Voltage Protection

Typical Characteristics

FLT Blanking Time

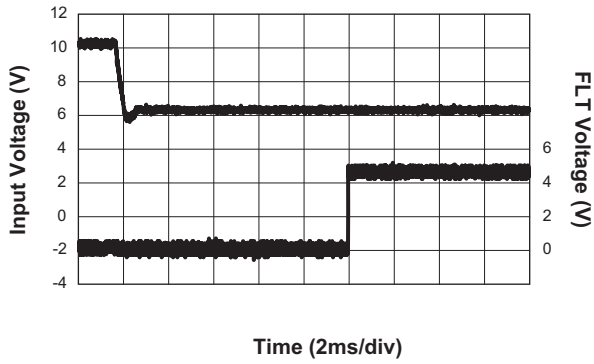

OVP Trip Point vs. Temperature

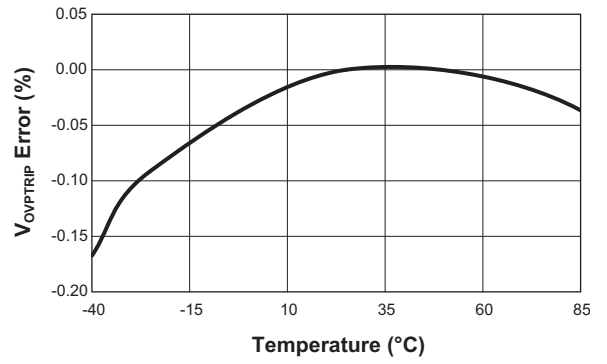

I-A Linear Li-Ion/Polymer Battery Charger with 28V Over-Voltage Protection

Functional Block Diagram

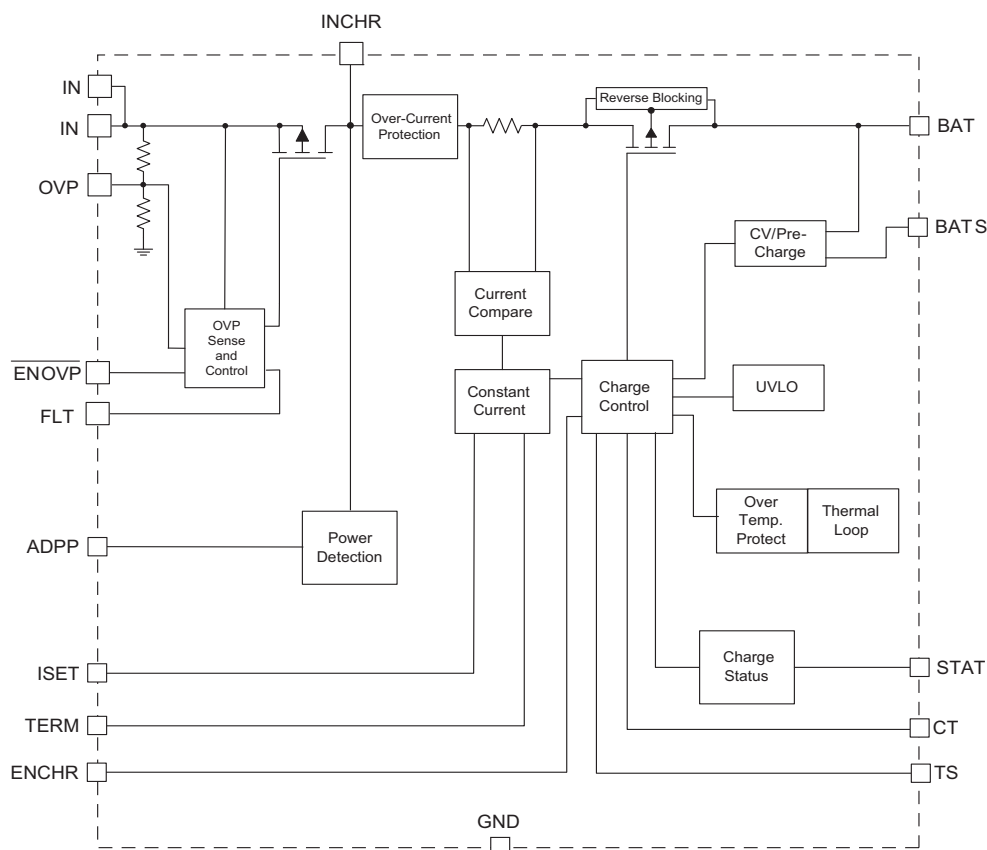

Functional Description

The AAT3783 is a high performance battery charger designed to charge single cell Lithium-Ion or Polymer batteries with up to 1000mA of current from an external power source. It is a stand-alone charging solution, with just one external component required (two more for options) for complete functionality. Also included is input voltage protection (OVP) to up to +28V. OVP consists of a low resistance P-channel MOSFET in series with the charge control MOSFET, and also consists of under-voltage lockout protection, over-voltage monitor, and fast shut-down circuitry with a fault output flag.

Battery Charging Operation

Figure 1 illustrates the entire battery charging profile or operation, which consists of three phases:

1. Preconditioning (Trickle) Charge
2. Constant Current Charge
3. Constant Voltage Charge

Battery Preconditioning

Battery charging commences only after the AAT3783 checks several conditions in order to maintain a safe charging environment. The input supply must be above the minimum operating voltage (V_{UVLO}) and the enable pin must be high. When the battery is connected to the BAT pin, the AAT3783 checks the condition of the battery and determines which charging mode to apply. If the battery voltage is below the preconditioning voltage threshold, V_{MIN} , then the AAT3783 begins preconditioning the battery cell (trickle charging) by charging at 10% of the programmed constant current. For example, if the programmed current is 500mA, then the preconditioning mode (trickle charge) current is 50mA. Battery cell preconditioning (trickle charging) is a safety precaution for deeply discharged cells and will also reduce the power dissipation in the internal series pass MOSFET when the input-output voltage differential is at the greatest potential.

I-A Linear Li-Ion/Polymer Battery Charger with 28V Over-Voltage Protection

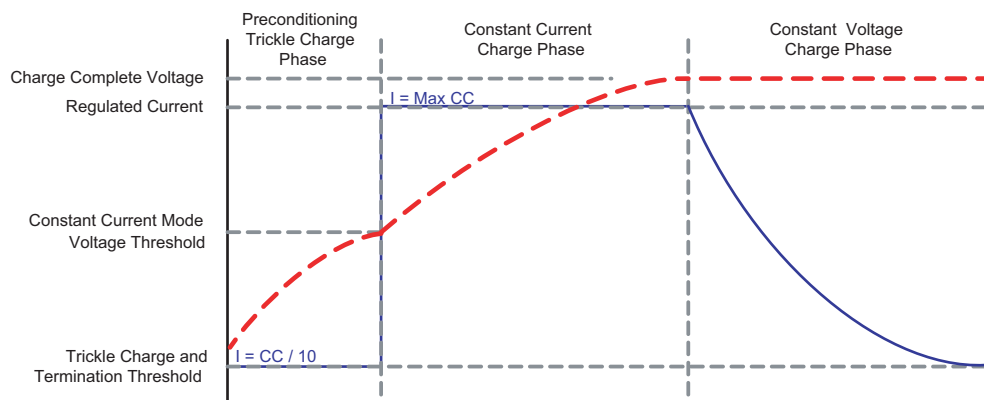

Figure 1: Current vs. Voltage Profile during Charging Phases.

Constant Current Charging

Battery cell preconditioning continues until the battery voltage reaches the preconditioning voltage threshold, V_{MIN} . At this point, the AAT3783 begins constant current charging. The current level for this mode is programmed using a single resistor from the ISET pin to ground. The programmed current can be set at a minimum 100mA up to a maximum of 1A.

Constant Voltage Charging

Constant current charging will continue until such time that the battery voltage reaches the voltage regulation point, V_{BAT_EOC} . When the battery voltage reaches V_{BAT_EOC} , the AAT3783 will transition to constant voltage mode. The regulation voltage is factory programmed to a nominal 4.2V and will continue charging until the charge termination current is reached.

Charge Status Output

The AAT3783 provides battery charge status via a status pin. This pin is internally connected to an N-channel open-drain MOSFET, which can be used drive an external LED. The status pin can indicate the following conditions:

Event Description	STATUS
No battery charging activity	OFF
Battery charging via adapter or USB port	ON
Charging completed	OFF

Table 1: LED Status Indicator.

Thermal Considerations

The actual maximum charging current is a function of the charge adapter input voltage, the battery charge state at the moment of charge, the ambient temperature, and the thermal impedance of the package. The maximum programmable current may not be achievable under all operating parameters.

Over-Voltage Protection

In normal operation, a P-channel MOSFET acts as a slew-rate controlled load switch, connecting and disconnecting the power supply from IN to INCHR. A low resistance MOSFET is used to minimize the voltage drop between the voltage source and the charger and to reduce the power dissipation. When the voltage on the input exceeds the over-voltage trip point (internally set by the factory or externally programmed by a resistor connected to the OVP pin), the device immediately turns off the internal P-channel FET which disconnects the charger from the abnormal input voltage, therefore preventing any damage to the charger. Simultaneously, the fault flag is raised, alerting the system.

If an over-voltage condition is applied at the time of the device enable, then the switch will remain OFF.

OVP Under-Voltage Lockout (UVLO)

The AAT3783 OVP circuitry has a fixed 3V under-voltage lockout level (UVLO). When the input voltage is less than the UVLO level, the MOSFET is turned off. 100mV of hysteresis is included to ensure circuit stability.

1-A Linear Li-Ion/Polymer Battery Charger with 28V Over-Voltage Protection**Over-Current Protection**

The AAT3783 over-current protection provides fault-condition protection that limits the charge current to approximately 1.6A under all conditions, even if the ISET pin gets shorted to ground.

FLT Blanking Time

The FLT output is an active-low open-drain fault (OV) reporting output. A pull-up resistor should be connected from FLT to the logic I/O voltage of the host system. FLT will be asserted immediately an over-voltage fault occurs (only about a 1 μ s inherited internal circuit delay). A 10ms blanking is applied to the FLT signal prior to de-assertion.

Enable / Disable

The AAT3783 provides an enable function to control the OVP stage and charger on and off independently.

$\overline{\text{ENOV}}P$ is an active-low enable input. $\overline{\text{ENOV}}P$ is driven low, connected to ground, or left floating for normal device operation. Taking $\overline{\text{ENOV}}P$ high turns off the MOSFET of the OVP stage. In the case of an over-voltage or UVLO condition, toggling $\overline{\text{ENOV}}P$ will not override the fault condition and the switch will remain off.

OVP Turn-On Delay Time

On initial power-up, if $V_{\text{IN}} < \text{UVLO}$ or if $V_{\text{OVP}} > 6.5\text{V}$ the PMOS is held off. If $\text{UVLO} < V_{\text{IN}}$, $V_{\text{OVP}} < 6.5\text{V}$, and $\overline{\text{ENOV}}P$ is low, the device enters startup after a 10ms internal delay.

I-A Linear Li-Ion/Polymer Battery Charger with 28V Over-Voltage Protection

System Operation Flow Chart

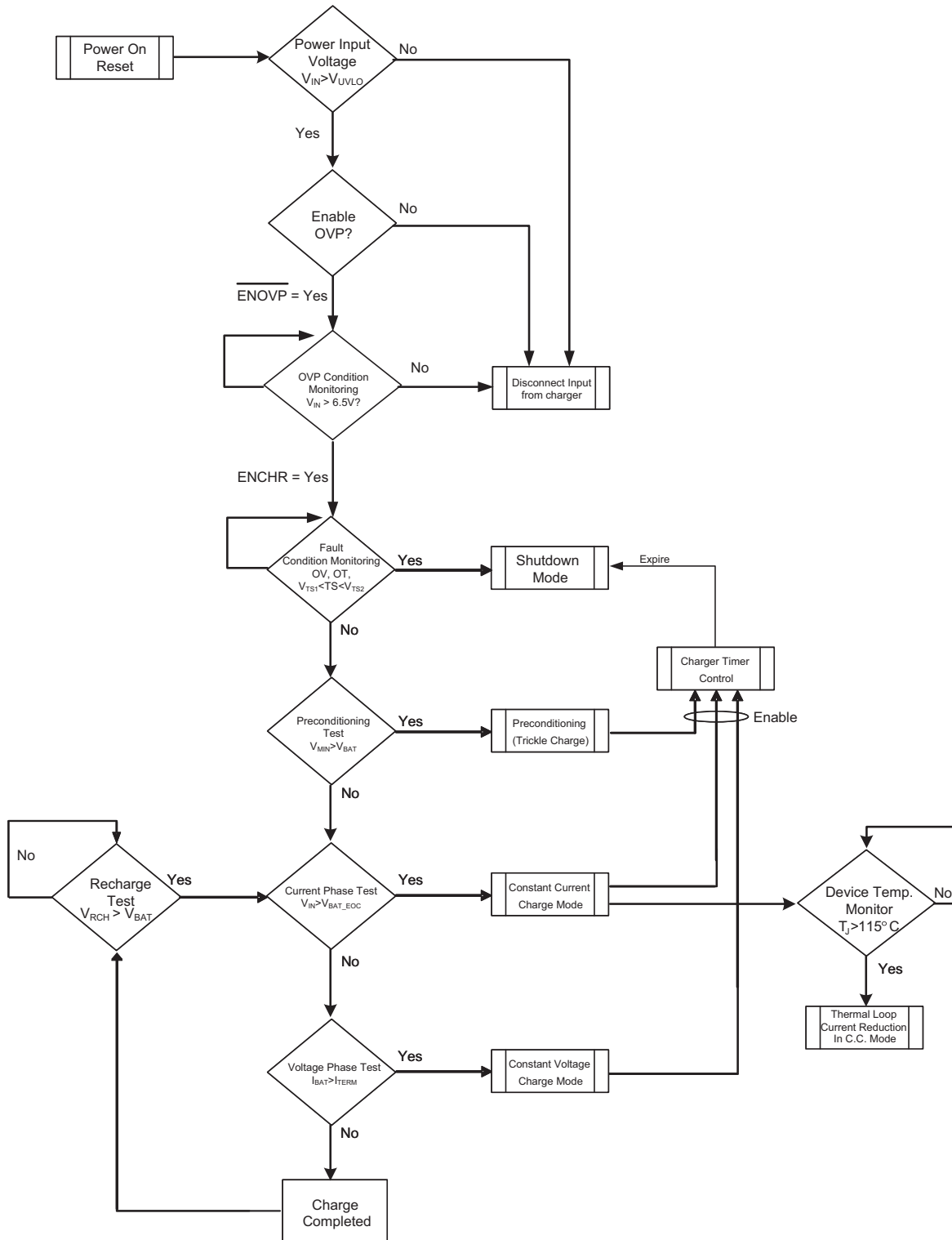

I-A Linear Li-Ion/Polymer Battery Charger with 28V Over-Voltage Protection

Application Information

Programming the Over-Voltage Protection Trip Point

The default over-voltage protection trip point of the AAT3783 is set to 6.5V by the factory. However, the over-voltage protection trip point can be programmed from 3.8V to 7.5V by the user with one external resistor, either R5 or R6. The placement of R5 is between IN and OVP. The placement of R6 is between OVP and GND. Table 2 summarizes resistor values for various over-voltage protection trip points. Use 1% tolerance metal film resistors for programming the desired OVP trip point.

R6 (kΩ)	R5 (kΩ)	V _{OVP_TRIP POINT} (V)
short	open	7.5
0.499	open	7.25
1.3	open	7.0
3.01	open	6.75
open	open	6.5
open	4.99	5.5
open	2.49	5.0
open	1.0	4.5
open	short	3.87

Table 2: Programming OVP Trip Point for AAT3783 with One Resistor.

Battery Connection and Battery Voltage Sensing

Battery Connection (BAT)

A single cell Li-Ion/Polymer battery should be connected between the BAT pin and ground.

Battery Voltage Sensing (BATS)

The BATS pin is provided to employ an accurate voltage sensing capability to measure the positive terminal voltage at the battery cell being charged. This function reduces measured battery cell voltage error between the battery terminal and the charge control IC. The AAT3783 charge control circuit will base charging mode states upon the voltage sensed at the BATS pin. The BATS pin must be connected to the battery terminal for correct operation. If the battery voltage sense function is not needed, the BATS pin should be terminated directly to the BAT pin. If there is concern of the battery sense function inadvertently becoming an open circuit, the

BATS pin may be terminated to the BAT pin using a 10kΩ resistor. Under normal operation, the connection to the battery terminal will be close to 0Ω; if the BATS connection becomes an open circuit, the 10kΩ resistor will provide feedback to the BATS pin from the BAT connection with a voltage sensing accuracy loss of 1mV or less.

Constant Charge Current

The constant current mode charge level is user programmed with a set resistor placed between the ISET pin and ground. The accuracy of the constant charge current, as well as the preconditioning trickle charge current, is dominated by the tolerance of the set resistor used. For this reason, a 1% tolerance metal film resistor is recommended for the set resistor function. The constant charge current levels from 100mA to 1A may be set by selecting the appropriate resistor value from Table 3.

Constant Charging Current (mA)	Set Resistor Value (kΩ)
10	162
20	80.6
50	32.4
100	16
200	8.06
300	5.36
400	4.02
500	3.24
600	2.67
700	2.26
800	2
900	1.78
1000	1.62

Table 3: R_{SET} Values.

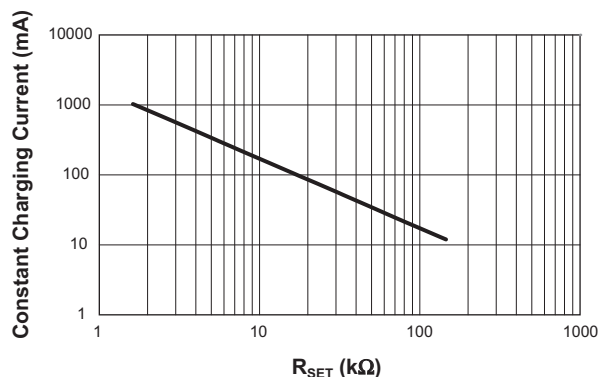

Figure 2: Constant Charging Current vs. Set Resistor Values.

I-A Linear Li-Ion/Polymer Battery Charger with 28V Over-Voltage Protection**Charge Termination Current**

The charge termination current I_{CH_TERM} can be programmed by connecting a resistor from TERM to GND:

$$I_{CH_TERM} = \frac{15\mu A \cdot R_{TERM}}{2V} \cdot I_{CH_CC}$$

Where:

I_{CH_TERM} = Charge termination current level

I_{CH_CC} = Programmed fast charge constant current level

R_{TERM} = TERM resistor value

If the TERM pin is left open, the termination current will set to 10% of the constant charging current as the default value.

When the charge current drops to the defaulted 10% of the programmed charge current level or programmed terminated current in the constant voltage mode, the device terminates charging and goes into a sleep state. The charger will remain in this sleep state until the battery voltage decreases to a level below the battery recharge voltage threshold (V_{RCH}).

Consuming very low current in sleep state, the AAT3783 minimizes battery drain when it is not charging. This feature is particularly useful in applications where the input supply level may fall below the battery charge or under-voltage lockout level. In such cases where the AAT3783 input voltage drops, the device will enter sleep state and automatically resume charging once the input supply has recovered from the fault condition.

Protection Circuitry**Programmable Watchdog Timer**

The AAT3783 contains a watchdog timing circuit to shut down charging functions in the event of a defective battery cell not accepting a charge over a preset period of time. Typically, a 0.1 μ F ceramic capacitor is connected between the CT pin and ground. When a 0.1 μ F ceramic capacitor is used, the device will time out a shutdown condition if the trickle charge mode exceeds 25 minutes and a combined trickle charge plus constant current mode of 3 hours. When the device transitions to the constant voltage mode, the timing counter is reset and will time out after an additional 3 hours if the charge current does not drop to the charge termination level.

Mode	Time
Trickle Charge (TC) Time Out	25 minutes
Trickle Charge (TC) + Constant Current (CC) Mode Time Out	3 hours
Constant Voltage (CV) Mode Time Out	3 hours

Table 4: Summary for a 0.1 μ F Ceramic Capacitor Used for the Timing Capacitor.

The CT pin is driven by a constant current source and will provide a linear response to increase in the timing capacitor value. Thus, if the timing capacitor were to be doubled from the nominal 0.1 μ F value, the time-out periods would be doubled. If the programmable watchdog timer function is not needed, it can be disabled by terminating the CT pin to ground. The CT pin should not be left floating or un-terminated, as this will cause errors in the internal timing control circuit.

The constant current provided to charge the timing capacitor is very small, and this pin is susceptible to noise and changes in capacitance value. Therefore, the timing capacitor should be physically located on the printed circuit board layout as close as possible to the CT pin. Since the accuracy of the internal timer is dominated by the capacitance value, a 10% tolerance or better ceramic capacitor is recommended. Ceramic capacitor materials, such as X7R and X5R types, are a good choice for this application.

Battery Over-Voltage Protection

An over-voltage event is defined as a condition where the voltage on the BAT pin exceeds the maximum battery charge voltage and is set by the over-voltage protection threshold (V_{BOVP}). If an over-voltage condition occurs, the AAT3783 charge control will shut down the device until the voltage on the BAT pin drops below V_{OVP} . The AAT3783 will resume normal charging operation after the over-voltage condition is removed.

Battery Temperature Monitoring

In the event of a battery over-temperature condition, the charge control will turn off the internal pass device. After the system recovers from a temperature fault, the device will resume charging operation. The AAT3783 checks battery temperature before starting the charge cycle, as well as during all stages of charging. This is accomplished by monitoring the voltage at the TS pin. This system is intended for use with negative temperature coefficient thermistors (NTC) which are typically integrated into the battery package. Most of the commonly used NTC therm-

I-A Linear Li-Ion/Polymer Battery Charger with 28V Over-Voltage Protection

istors in battery packs are approximately 10kΩ at room temperature (25°C). The TS pin has been specifically designed to source 75μA of current to the thermistor. The voltage on the TS pin resulting from the resistive load should stay within a window of 331mV to 2.39V. If the battery becomes too hot during charging due to an internal fault or excessive constant charge current, the thermistor will heat up and reduce in value, pulling the TS pin voltage lower than the TS1 threshold, and the AAT3783 will stop charging until the condition is removed, when charging will be resumed. If the use of the TS pin function is not required by the system, it should be terminated to ground using a 10kΩ resistor. Alternatively, on the AAT3783, the TS pin may be left open.

Over-Temperature Shutdown

The AAT3783 has a thermal protection control circuit which will shut down charging functions should the internal die temperature exceed the preset thermal limit threshold. Once the internal die temperature falls below the thermal limit, normal operation will resume the previous charging state.

Digital Thermal Loop Control

Due to the integrated nature of the linear charging control pass device for the adapter mode, a special thermal loop control system has been employed to maximize charging current under all operation conditions. The thermal management system measures the internal circuit die temperature and reduces the fast charge current when the device exceeds a preset internal temperature control threshold. Once the thermal loop control becomes active, the fast charge current is initially reduced by a factor of 0.44.

The initial thermal loop current can be estimated by the following equation:

$$I_{TLOOP} = I_{CH_CC} \cdot 0.44$$

The thermal loop control re-evaluates the circuit die temperature every three seconds and adjusts the fast charge current back up in small steps to the full fast charge current level or until an equilibrium current is discovered and maximized for the given ambient temperature condition. The thermal loop controls the system charge level; therefore, the AAT3783 will always provide the highest level of constant current in the fast charge mode possible for any given ambient temperature condition.

Thermal Considerations

and High Output Current Applications

The AAT3783 is designed to deliver a continuous charging current. The limiting characteristic for maximum safe operating charging current is its package power dissipation. Many considerations should be taken into account when designing the printed circuit board layout, as well as the placement of the IC package in proximity to other heat generating devices in a given application design. The ambient temperature around the IC will also have an effect on the thermal limits of a battery charging application.

The maximum limits that can be expected for a given ambient condition can be estimated by the following discussion. First, the maximum power dissipation for a given situation should be calculated:

$$P_{D(MAX)} = \frac{(T_{J(MAX)} - T_A)}{\theta_{JA}}$$

Where:

- $P_{D(MAX)}$ = Maximum Power Dissipation (W)
- θ_{JA} = Package Thermal Resistance (°C/W)
- T_J = Thermal Loop Entering Threshold (°C) [115°C]
- T_A = Ambient Temperature (°C)

Figure 3 shows the relationship of maximum power dissipation and ambient temperature of AAT3783.

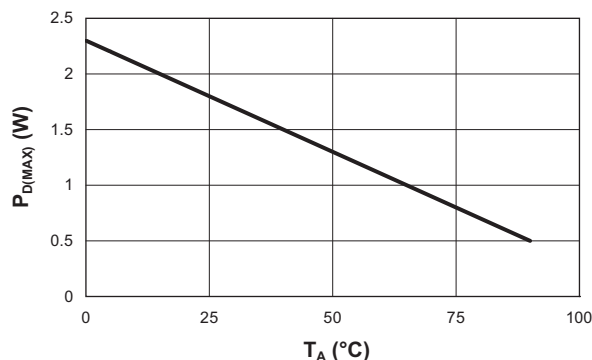

Figure 3: Maximum Power Dissipation Before Entering Digital Thermal Loop.

Next, the power dissipation can be calculated by the following equation:

$$P_D = [(V_{IN} - V_{BAT}) \cdot I_{CH} + (V_{IN} \cdot I_{OP})]$$

I-A Linear Li-Ion/Polymer Battery Charger with 28V Over-Voltage Protection

Where:

P_D = Total Power Dissipation by the Device

V_{IN} = Input Voltage

V_{BAT} = Battery Voltage as Seen at the BAT Pin

I_{CH} = Constant Charge Current Programmed for the Application

I_{OP} = Quiescent Current Consumed by the Charger IC for Normal Operation [0.4mA]

By substitution, we can derive the maximum charge current before reaching the thermal limit condition (thermal loop). The maximum charge current is the key factor when designing battery charger applications.

$$I_{CH(MAX)} = \frac{(P_{D(MAX)} - V_{IN} \cdot I_{OP})}{V_{IN} - V_{BAT}}$$

$$I_{CH(MAX)} = \frac{\frac{(T_{J(MAX)} - T_A)}{\theta_{JA}} - V_{IN} \cdot I_{OP}}{V_{IN} - V_{BAT}}$$

In general, the worst condition is the greatest voltage drop across the charger IC, when battery voltage is charged up to the preconditioning voltage threshold and before entering thermal loop regulation. Figure 4 shows the maximum charge current in different ambient temperatures.

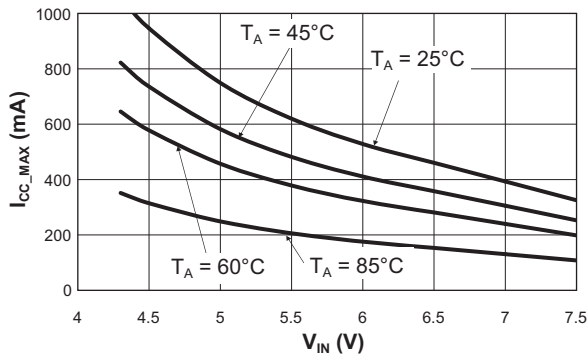

Figure 4: Maximum Charging Current Before the Digital Thermal Loop Becomes Active.

Input Capacitor

A 1 μ F or larger capacitor is typically recommended for C_{IN} . C_{IN} should be located as close to the device V_{IN} pin as practically possible. Ceramic, tantalum, or aluminum electrolytic capacitors may be selected for C_{IN} . There is

no specific capacitor equivalent series resistance (ESR) requirement for C_{IN} . However, for higher current operation, ceramic capacitors are recommended for C_{IN} due to their inherent capability over tantalum capacitors to withstand input current surges from low impedance sources such as batteries in portable devices.

Typically, 50V rated capacitors are required for most of the application to prevent any surge voltage. Ceramic capacitors selected as small as 1210 are available which can meet these requirements. Other voltage rating capacitor can also be used for the known input voltage application.

Charger Input Capacitor

A 2.2 μ F decoupling capacitor is recommended to be placed between INCHR and GND.

Charger Output Capacitor

The AAT3783 only requires a 1 μ F ceramic capacitor on the BAT pin to maintain circuit stability. This value should be increased to 10 μ F or more if the battery connection is made any distance from the charger output. If the AAT3783 is used in applications where the battery can be removed from the charger, such as with desktop charging cradles, an output capacitor greater than 10 μ F may be required to prevent the device from cycling on and off when no battery is present.

Printed Circuit Board Layout Recommendations

For proper thermal management and to take advantage of the low $R_{DS(ON)}$ of the AAT3783, a few circuit board layout rules should be followed: V_{IN} and V_{OUT} should be routed using wider than normal traces, and GND should be connected to a ground plane. To maximize package thermal dissipation and power handling capacity of the AAT3783 DFN34 package, solder the exposed paddle of the IC onto the thermal landing of the PCB, where the thermal landing is connected to the ground plane. This AAT3783 has two exposed paddles (EP1 and EP2). EP1 is connected to INCHR (pin 1) and EP2 is connected to GND (pin 13). DO NOT make one whole thermal landing! If heat is still an issue, multi-layer boards with dedicated ground planes are recommended. Also, adding more thermal vias on the thermal landing would help the heat being transferred to the PCB effectively.

DATA SHEET

AAT3783

1-A Linear Li-Ion/Polymer Battery Charger with 28V Over-Voltage Protection

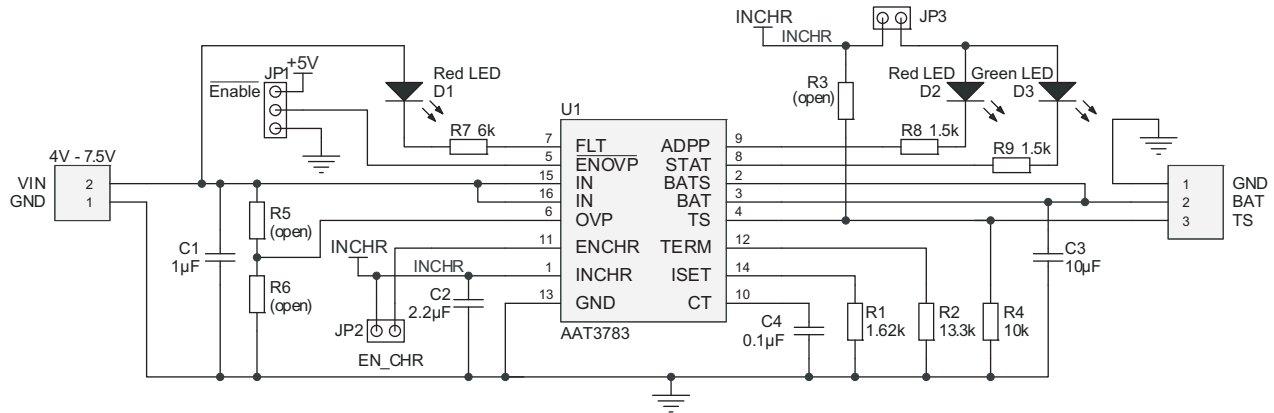

C1 1206 X7R 1µF 50V GRM31MR71H105KA88
 (C1 1206 X7R 2.2µF 50V GRM31CR71H225KA88L)
 (C1 1210 X7R 4.7µF 50V GRM32ER71H475KA88L)
 C2 0805 X5R 2.2µF 10V GRM188R61A225KE34
 C3 0805 X7R 10µF 10V GRM21BR71A106KE51L

Figure 5: AAT3783 Evaluation Board Schematic.

Component	Part#	Description	Manufacturer
U1	AAT3783IRN	1A Linear Li-Ion/Polymer Battery Charger with 28V Over-Voltage Protection; TDFN Package	Skyworks
R1	Chip Resistor	1.62KΩ, 1%, 1/4W; 0603	Vishay
R2	Chip Resistor	13.3KΩ, 1%, 1/4W; 0603	Vishay
R4	Chip Resistor	10KΩ, 5%, 1/4W; 0603	Vishay
R7	Chip Resistor	6KΩ, 5%, 1/4W; 0603	Vishay
R8, R9	Chip Resistor	1.5KΩ, 5%, 1/4W; 0603	Vishay
C1	GRM31MR71H105KA88	CER 1µF 50V 10% X7R 1206	Murata
C2	GRM188R61A225KE34	CER 2.2µF 10V 10% X5R 0805	Murata
C3	GRM21BR71A106KE51L	CER 10µF 10V 10% X7R 0805	Murata
C4	GRM188R71E104KA01	CER 0.1µF 25V 10% X7R 0603	Murata
JP1, JP2, JP3	PRPN401PAEN	Conn. Header, 2mm zip	Sullins Electronics
D1, D2	CMD15-21SRC/TR8	Red LED; 1206	Chicago Miniature Lamp
D3	CMD15-21VGC/TR8	Green LED; 1206	Chicago Miniature Lamp

Table 5: AAT3783 Evaluation Board Bill of Materials.

AAT3783

I-A Linear Li-Ion/Polymer Battery Charger with 28V Over-Voltage Protection

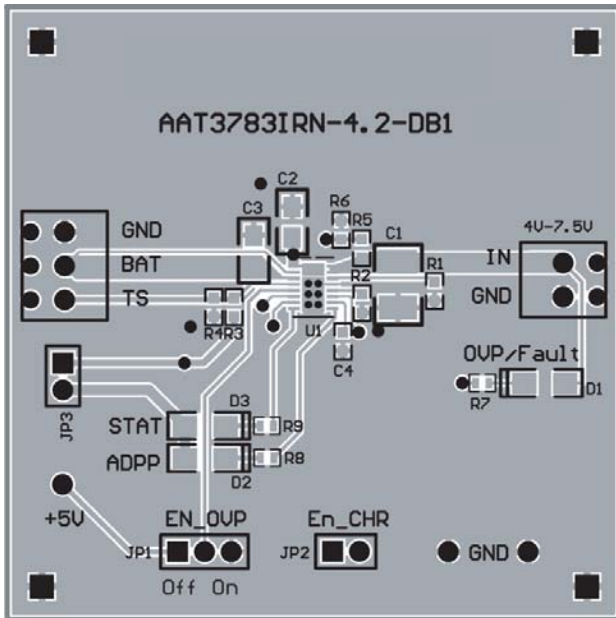

Figure 5: AAT3783 Evaluation Board Top Layer.

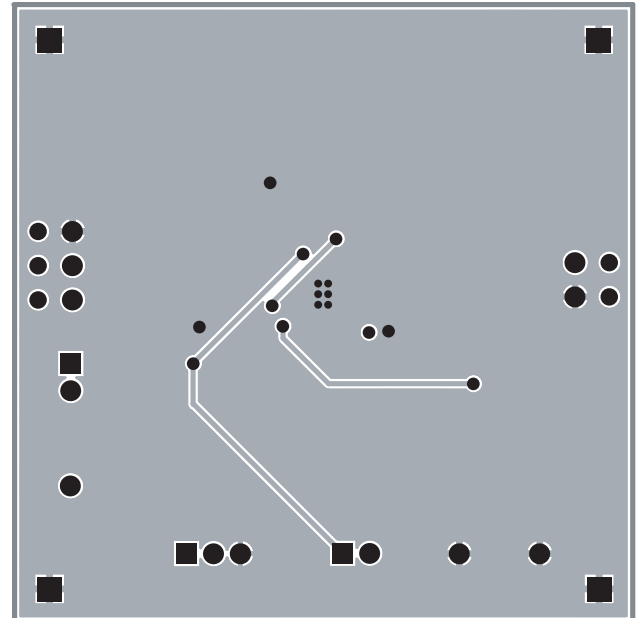

Figure 6: AAT3783 Evaluation Board Middle Layer.

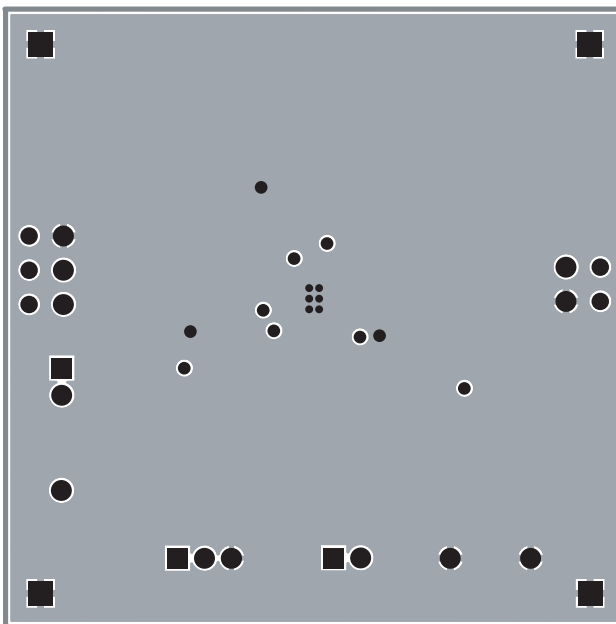

Figure 7: AAT3783 Evaluation Board Bottom Layer.

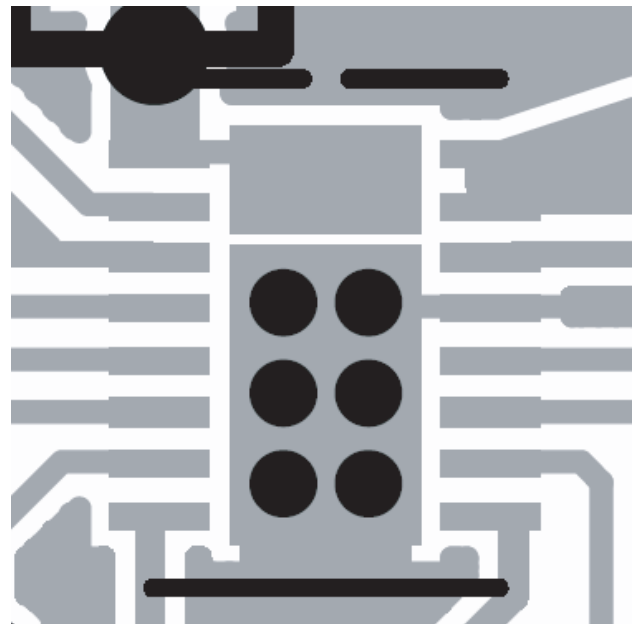

Figure 8: Magnified View of Exposed Paddles on AAT3783 Evaluation Board Top Layer.

I-A Linear Li-Ion/Polymer Battery Charger with 28V Over-Voltage Protection**Ordering Information**

Package	Marking ¹	Part Number (Tape and Reel) ²
TDFN34-16	XQXY	AAT3783IRN-4.2-T1



Skyworks Green™ products are compliant with all applicable legislation and are halogen-free.

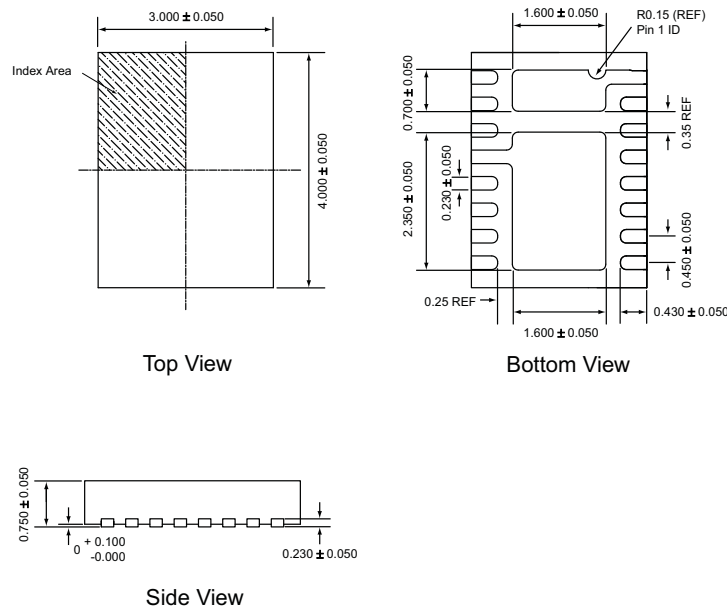

For additional information, refer to *Skyworks Definition of Green™*, document number SQ04-0074.

Package Information**TDFN34-16**

All dimensions in millimeters.

1. XYY = assembly and date code.
2. Sample stock is generally held on part numbers listed in **BOLD**.
3. The leadless package family, which includes QFN, TQFN, DFN, TDFN and STDFN, has exposed copper (unplated) at the end of the lead terminals due to the manufacturing process. A solder fillet at the exposed copper edge cannot be guaranteed and is not required to ensure a proper bottom solder connection.

Information in this document is provided in connection with Skyworks Solutions, Inc. ("Skyworks") products or services. These materials, including the information contained herein, are provided by Skyworks as a service to its customers and may be used for informational purposes only by the customer. Skyworks assumes no responsibility for errors or omissions in these materials or the information contained herein. Skyworks may change its documentation, products, services, specifications or product descriptions at any time, without notice. Skyworks makes no commitment to update the materials or information and shall have no responsibility whatsoever for conflicts, incompatibilities, or other difficulties arising from any future changes.

No license, whether express, implied, by estoppel or otherwise, is granted to any intellectual property rights by this document. Skyworks assumes no liability for any materials, products or information provided hereunder, including the sale, distribution, reproduction or use of Skyworks products, information or materials, except as may be provided in Skyworks Terms and Conditions of Sale.

THE MATERIALS, PRODUCTS AND INFORMATION ARE PROVIDED "AS IS" WITHOUT WARRANTY OF ANY KIND, WHETHER EXPRESS, IMPLIED, STATUTORY, OR OTHERWISE, INCLUDING FITNESS FOR A PARTICULAR PURPOSE OR USE, MERCHANTABILITY, PERFORMANCE, QUALITY OR NON-INFRINGEMENT OF ANY INTELLECTUAL PROPERTY RIGHT; ALL SUCH WARRANTIES ARE HEREBY EXPRESSLY DISCLAIMED. SKYWORKS DOES NOT WARRANT THE ACCURACY OR COMPLETENESS OF THE INFORMATION, TEXT, GRAPHICS OR OTHER ITEMS CONTAINED WITHIN THESE MATERIALS. SKYWORKS SHALL NOT BE LIABLE FOR ANY DAMAGES, INCLUDING BUT NOT LIMITED TO ANY SPECIAL, INDIRECT, INCIDENTAL, STATUTORY, OR CONSEQUENTIAL DAMAGES, INCLUDING WITHOUT LIMITATION, LOST REVENUES OR LOST PROFITS THAT MAY RESULT FROM THE USE OF THE MATERIALS OR INFORMATION, WHETHER OR NOT THE RECIPIENT OF MATERIALS HAS BEEN ADVISED OF THE POSSIBILITY OF SUCH DAMAGE.

Skyworks products are not intended for use in medical, lifesaving or life-sustaining applications, or other equipment in which the failure of the Skyworks products could lead to personal injury, death, physical or environmental damage. Skyworks customers using or selling Skyworks products for use in such applications do so at their own risk and agree to fully indemnify Skyworks for any damages resulting from such improper use or sale.

Customers are responsible for their products and applications using Skyworks products, which may deviate from published specifications as a result of design defects, errors, or operation of products outside of published parameters or design specifications. Customers should include design and operating safeguards to minimize these and other risks. Skyworks assumes no liability for applications assistance, customer product design, or damage to any equipment resulting from the use of Skyworks products outside of stated published specifications or parameters.

Skyworks, the Skyworks symbol, and "Breakthrough Simplicity" are trademarks or registered trademarks of Skyworks Solutions, Inc., in the United States and other countries. Third-party brands and names are for identification purposes only, and are the property of their respective owners. Additional information, including relevant terms and conditions, posted at www.skyworksinc.com, are incorporated by reference.