





molex®







**IMPACT™ Backplane and DaughterCard
Installation and Repair Tooling
Operation Manual
Order No. 62201-8799**

- Description
- Operation
- Maintenance

Safety Warnings and Information

	<p>Read and understand all of the instructions and safety information in this manual before operating or servicing this tool.</p> <p style="text-align: center;"><u>Keep this manual available when using this tool.</u></p> <p>Replacement manuals are available for download at no charge at www.molex.com.</p>
---	---

SAFETY ALERT SYMBOL	
This symbol is used to call your attention to hazards or unsafe practices which could result in an injury or property damage. The signal word, defined below, indicates the severity of the hazard. The message after the signal word provides information for preventing or avoiding the hazard.	
 DANGER	<p>DANGER: Indicates an imminently hazardous situation which, if not avoided, could result in death or serious injury.</p>
 WARNING	<p>WARNING: Indicates a potentially hazardous situation which, if not avoided, could result in death or serious injury.</p>
 CAUTION	<p>CAUTION: Indicates a potentially hazardous situation which, if not avoided, may result in minor or moderate injury. CAUTION may also be used to alert against unsafe practices associated with events that could lead to personal injury.</p>

	<p> WARNING</p> <p>Always wear proper eye protection when Operating or servicing these tools.</p> <p>Failure to wear eye protection could result in serious eye injury from flying debris.</p>		<p> WARNING</p> <p>Never use a press without guards or safety devices that are intended to prevent hands from remaining in the die space. Failure to observe this warning could result in severe injury or death.</p>
	<p> WARNING</p> <p>Never wear clothing or jewelry that is loose or That Could potentially hang into the equipment And get caught.</p> <p>Failure to observe this warning could result in Severe Injury or death.</p>		<p> WARNING</p> <p>Never install or service these tool while connected to any electrical power source. Disconnect power by unplugging the press from its power source.</p> <p>Failure to observe this warning could result In severe injury or death.</p>
	<p> WARNING</p> <p>Never operate, service, install, or adjust this Machine without proper instruction and without first reading and understanding the instructions in this manual and all applicable press and/or wire processing machine manuals.</p>		<p> WARNING</p> <p>Use extreme caution when using compressed air to clean the equipment. The forces created by compressed air can force debris into the tool.</p> <p>Failure to observe these precautions may result in injury or property damage.</p>



CAUTION

Never perform any service or maintenance other than as described in this manual.
Never modify, alter or misuse the equipment

Failure to observe this precaution may result in injury and property damage.

Tooling Technical Assistance

Molex offers tooling technical assistance for customers who may need some guidance for tooling adjustments. This support can be obtained by calling either of the two numbers listed below and asking for the Molex Tooling Group. Call Toll Free 1-800-786-6539 (US) 1-630-969-4550 (Global).

This assistance is limited to the operation and set-up of a customer's Molex Tools tool. Questions with regard to Molex connector products or how to identify the proper tooling and/ or tooling documentation should be directed to your local Molex personnel or Customer Service Representative.

When calling for service on these tools it is recommended to have the following: a copy of the Operation Manual, the Specific Application Specification Sheet and a person familiar with the tools should be present. The following information is also recommended to supply:

1. Customer name
2. Customer address
3. Person to contact such as (name, title, e-mail, and telephone number)
4. Tools order number (Lease number also if applicable)
5. Serial number (Lease number also if applicable)
6. Molex Connector product order number
7. Urgency of request
8. Nature of problem

Molex Application Tooling Group

2200 Wellington Court
Lisle, IL 60532, USA
Tel: +1 (630) 969-4550
Fax: +1 (630) 505-0049

Visit our Web site at <http://www.molex.com>

Table of Contents

IMPACT™ Backplane and DaughterCard	1
Order No. 62201-8799.....	1
Safety Warnings and Information	2
Table of Contents	4
Section 1.....	5
General Description.....	6
1.1 Description	6
1.2 Features	6
1.3 Technical Specifications.....	6
1.4 Delivery Check.....	6
1.5 Tools	6
1.6 Press Requirements.....	6
Section 2.....	7
Installation and Operation	7
2.1 Printed Circuit Board Support	8
2.2 Press Stroke Adjustment.....	8
2.3 Installation.....	8
2.4 Operation	9
Section 3.....	13
Maintenance.....	13
3.1. Cleaning	14
3.2 Lubrication.....	14
3.3 Troubleshooting	14
Section 4.....	15
Available Tools.....	15
4.1 Standard Press-In-Tools	16
Table 4-1.....	16
Table 4-2.....	25
Table 4-3.....	25
4.2 Standard Tool Ordering Procedure	29
Section 5.....	30
5.1 Impact™ Backplane Repair Procedure:.....	31
5.2 Glossary of Terms:.....	35

Section 1

Press Requirements for Impact™ Connectors

- 1.1 Description
- 1.2 Features
- 1.3 Technical Specifications
- 1.4 Delivery Check
- 1.5 Tools
- 1.6 Press Requirements

General Description

1.1 Description

This manual covers the tooling available to press Molex Impact™ Backplane Power Modules, Backplane Connectors, Daughtercard and Coplanar Modules into printed circuit boards. Repair tools and custom tools are also covered. All insertion tooling is designed to go into a flat platen press.

1.2 Features

The press-in tooling is designed so that one module will press in one connector, or several modules can be mounted in a tool holder and be used to press in any combination of connectors in one operation. See Section 4-2 (Ordering Instructions) for details.

1.3 Technical Specifications

Dimensions and Weight

The dimensions and weight depend on the size of the tooling used.

1.4 Delivery Check

Carefully remove the tooling from its shipping container and check to be sure what was received matches the purchase order and no damage has occurred.

1.5 Tools

A metric hex wrench set will be required to assemble or disassemble tooling mounted in the optional tooling holder.

Molex Presses

Molex does not offer a press that is suitable for this application. The customer is encouraged to use one of the many industry-standard presses to install the Impact™ connectors.

1.6 Press Requirements

All Impact™ insertion tools are designed to fit in a flat platen (or flat rock) press.

The press must have sufficient working area to accept the size of the printed circuit board.

The press frame and base must withstand the insertion force requirements for the Impact™ products.

Insertion Force Requirements

Backplane assemblies: 2.7kgf (6 lb.) per pin

Daughtercard assemblies: 1.8kgf (4 lb.) per pin

Power module assemblies: 6kgf (13.2 lb.) per pin

Press Operation Characteristics

- The capability to detect force variations as low as 4.5kg (10 lb.) during the press-in cycle; excessive force measurement should stop the press-in cycle.
- The rate of pressing can be regulated as low as 0.13mm (0.005 in) per second.
- Press stroke control to within $\pm 0.25\text{mm}$ (0.010 in.).
- Total press stroke must be at least 19mm (0.75 in.).

Section 2

Installation and Operation

- 2.1 Printed Circuit Board Support
- 2.2 Press Stroke Adjustment
- 2.3 Installation
- 2.4 Operation

Installation and Operation

2.1 Printed Circuit Board Support

Due to the high forces required to press in compliant-pin connectors, a backup or support plate is suggested to prevent damage to the printed circuit board. The support fixture should have clearance for the connector terminals if they protrude through the underside of the printed circuit board. The support fixture should have some method of locating the PCB consistently. Due to the custom nature of each application, Molex does not supply support and locating fixtures. The customer normally fabricates the fixture to fit their application.

The following is one way of making a printed circuit board support and locating fixture:

1. Locate a suitable piece of material for the backup. It should be approximately 20mm thick and the same size or slightly larger than the printed circuit board to be used. While aluminum could be used, a rigid nonconductive material such as a phenolic is preferred. (A stack of scrap printed circuit boards of suitable size can also be fastened together.)
2. Obtain a scrap printed circuit board like the ones to be assembled. Attach this board to the material from step 1.
3. Using an oversize drill bit, drill through each hole where a pin from the connector will go. Drill deep enough into the lower material to be certain the pins do not bottom out when inserted (at least 5.0mm (0.20") deep).
4. Locate two (2) holes on the printed circuit board to use as locating points. Mount suitably sized dowel pins in these two locations on the support fixture.
5. Clear out the support for any components mounted on the underside of the printed circuit board.
6. Place a printed circuit board on top of the support, located by the two pins, and check that the holes for the connector pins are aligned.
7. By hand, pre-insert a connector in the printed circuit board.
8. Load the insertion tool into the connector.
9. Place the support with the printed circuit board under the press ram.
10. Press the connector into the printed circuit board and observe for any deflection of the board when the ram is at the bottom of its stroke.

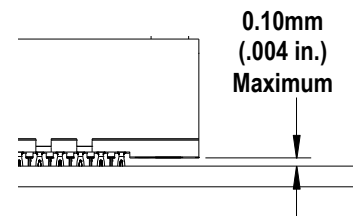

Figure 2-1
MAXIMUM CLEARANCE WHEN
CONNECTOR FULLY SEATED

2.2 Press Stroke Adjustment

Most presses have some means of adjusting the stroke; please refer to the press manual for press stroke adjustments. The stroke should be adjusted so that when the press ram stops in the down position, the bottom of the connector is flush to 0.10mm (.004") above the surface of the printed circuit board. See Figure 2-1.

2.3 Installation

To install insertion modules into a tooling holder (see Table 4-2), use the following procedure:

1. Along the lower edge of the tooling holder is a row of M3 set screws. (See Figure 2-2) Loosen these a few turns so that they do not protrude into the inside of the holder.
2. Slide the insertion modules into the tooling holder in the proper order. See Figure 2-3. The modules are keyed so that they cannot be installed backwards.

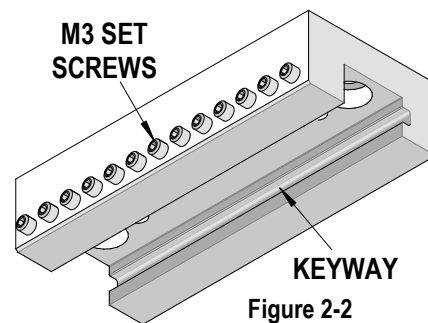

Figure 2-2
TOOLING HOLDER

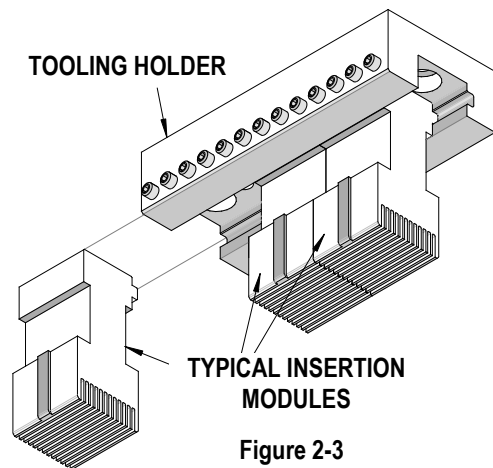

Figure 2-3
MOUNTING INSERT MODULE IN
A MOUNTING BLOCK

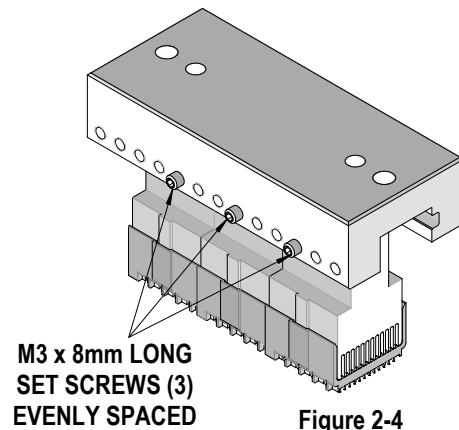

Figure 2-4
TYPICAL INSERTION
TOOL ASSEMBLY

3. Tighten the M3 set screws against the modules with two (2) set screws evenly spaced on a 10mm wide insertion tool and at least three (3) set screws evenly spaced on a 25mm wide insertion tool. Figure 2-4 shows a typical completed assembly.



CAUTION: Do not over tighten the setscrews; this could damage the insertion tool.

NOTE: See Section 4 for details on selecting modules and Press-In tools combinations.

2.4 Operation

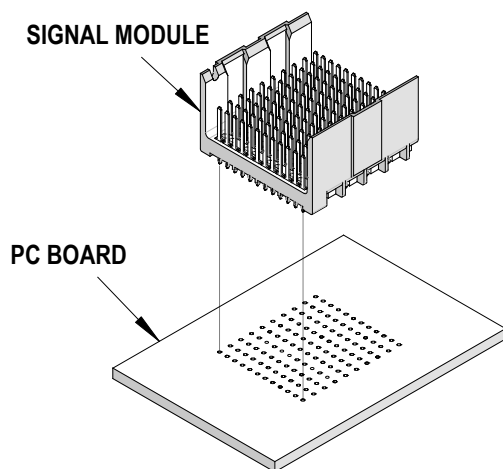

Figure 2-5
ALIGNING TERMINAL PINS TO HOLES

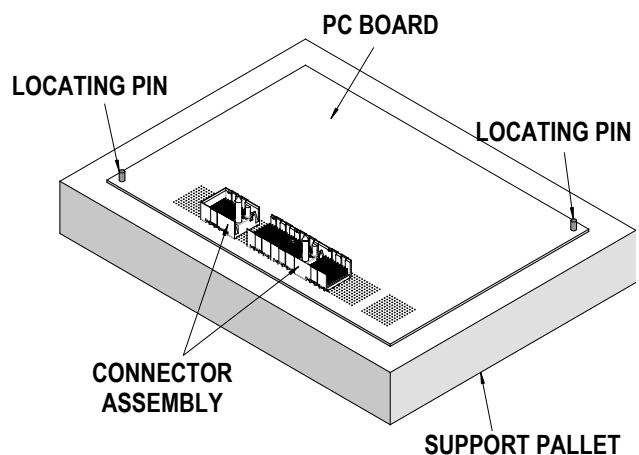

Figure 2-6
CONNECTOR ASSEMBLY
ON PC BOARD SUPPORT PALLET

Backplane Insertion Tooling

1. Carefully pre-insert, by hand, the backplane signal module(s) into the printed circuit board hole pattern. Make sure the connector(s) are oriented properly by confirming the location of the #1 circuit notch with respect to the printed circuit board layout. See Figure 2-5.
2. Place the pre-loaded board into the support pallet (Optional). See Figure 2-6.
3. Locate the tooling assembly in the connector assembly, carefully checking alignment. The orientation keys on the tool must engage with the groove on the connector housing. See Figure 2-7.
4. Position the pre-loaded support pallet under the press ram.

5. Cycle the insertion press.
6. Press the header assembly until there is less than 0.10mm (.004 in) clearance between the bottom of the plastic housing and the surface of the printed circuit board.
7. Remove the loaded support pallet.
8. Carefully remove the insertion tool assembly. Remove the printed circuit board from the pallet.

Daughtercard Insertion Tooling

Operation for inserting daughtercard assemblies is similar to backplanes and can be used alone or stacked in a tool holder for larger connector assemblies. See Figure 2-8.

1. Locate the daughtercard connector assembly on the printed circuit board.
2. Pre-insert the assembly into the board by hand. Check for proper seating, without contact pins bending under the assembly after pre loading on to the Printed circuit board. See Figure 2-9.

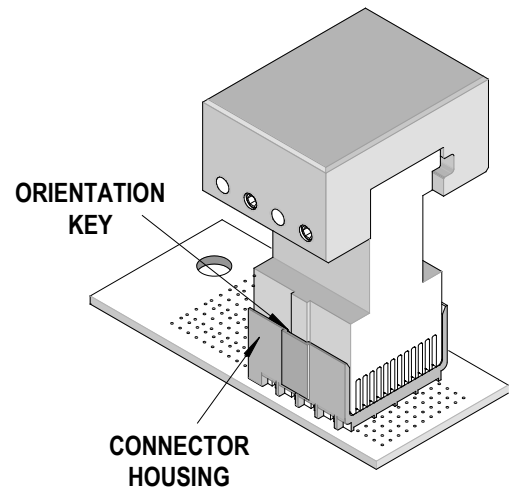

Figure 2-7
TOOLING LOCATED IN THE
CONNECTOR ASSEMBLY

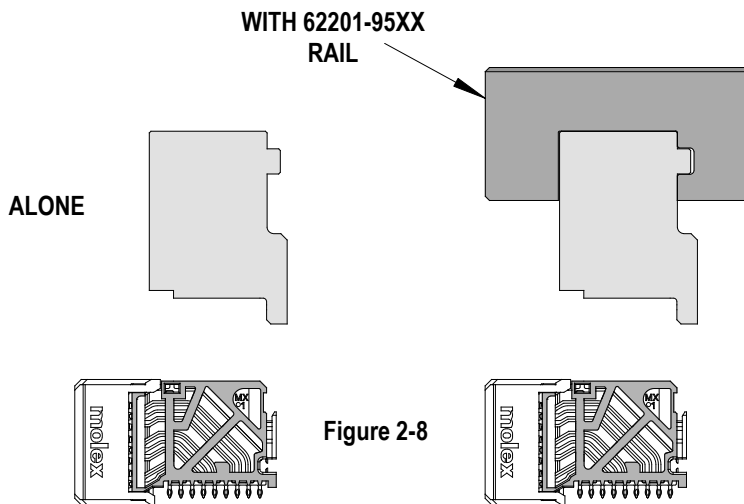

Figure 2-8

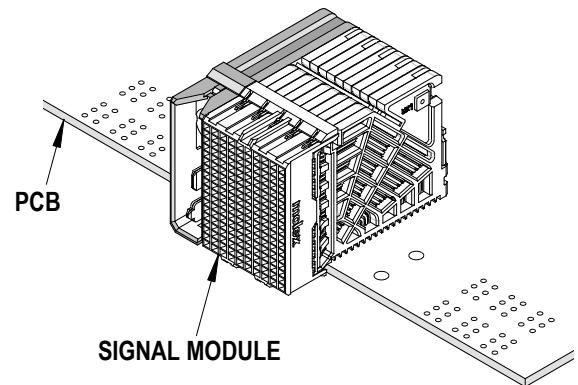

Figure 2-9
TYPICAL DAUGHTERCARD
ASSEMBLY ON THE PC BOARD

3. Locate the printed circuit board with the connector assembly on the support pallet.
4. Position the insertion tooling on the connector assembly. See Figure 2-10. Position the printed circuit board under the press platen (Optional).



CAUTION: To prevent injury, never operate any press without the guards in place. Refer to the press manufacturer's instruction manual.

5. Press the daughtercard module until there is less than 0.10mm (.004 in) clearance between the bottom of the plastic housing and the surface of the printed circuit board.
6. Remove the loaded support pallet from the press.
7. Remove the insertion tool.
8. Carefully remove the assembled printed circuit board from the support pallet.

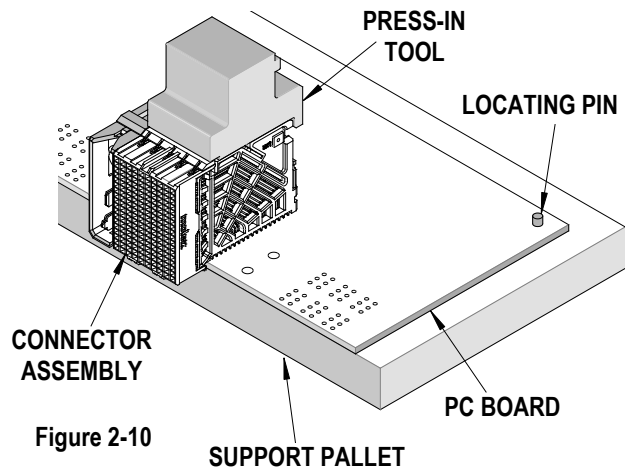

Figure 2-10

Vertical Power Module Press-In Tooling



CAUTION: Vertical Power Module must be installed separately without any backplane or daughtercard assemblies in the combinations.

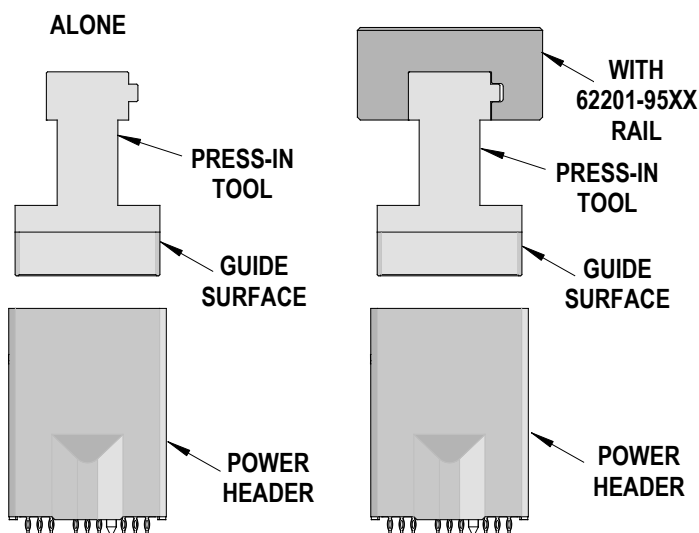

Figure 2-11

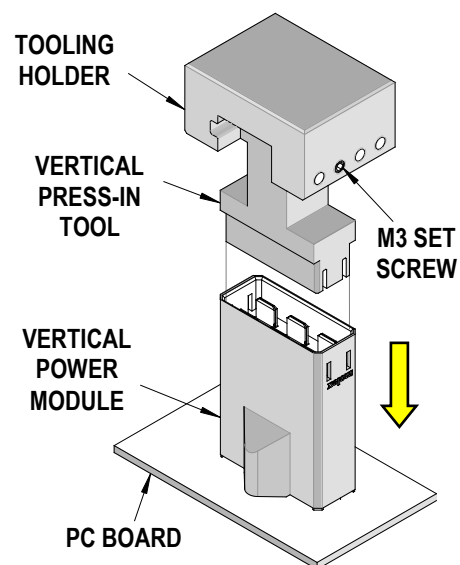

Figure 2-12

Depending on the number of modules to be installed and/or the press used, this tool can be used as a stand-alone or with a group of press-in tools, mounted in a 62201-95XX holder (ordered separately). See Figure 2-11.

1. If the tooling holder is being used, slide the insertion modules into the tooling holder in the proper order. The modules are keyed so that they cannot be installed backwards.
2. Now tighten the M3 set screws against the modules using the following setups:
 - One (1) set screw against modules under 10mm wide
 - Two (2) set screws evenly spaced on a 10mm wide power module.
 - At least three (3) set screws evenly spaced on a 25mm wide power module.
3. Carefully pre-insert, by hand, the vertical power module(s) into the printed circuit board hole pattern. See Figure 2-12. Make sure the module(s) are oriented properly to the printed circuit board layout.
4. Line-up the Press-In tool so that the guide surfaces on the tool are in line with the sides of the vertical power module. See Figure 2-11.
5. Using the application tool and an appropriate press, seat the vertical power module until there is less than 0.10mm (.004 in) clearance between the bottom of the plastic housing and the surface of the printed circuit board.



CAUTION: To prevent injury, never operate any press without the guards in place. Refer to the press manufacturer's instruction manual.

Right Angle Power Module Press-In Tooling

Depending on the number of connectors to be installed and/or the press used, this tool can be used alone or with a group of press-in tools, mounted in a 62201-95XX holder (ordered separately). See Figure 2-13 and 2-14.

1. If the tooling holder is being used, slide the Press-In Tools into the tooling holder in the proper order. The Press-In Tools are keyed so that they cannot be installed backwards.
2. Tighten the M3 set screws against the Press-In Tool using the following setups:
 - One (1) set screw is used against the Press-In Tool under 10mm guide module.
 - Two (2) set screws evenly spaced on a 10mm wide Press-In Tool.
 - At least three (3) set screws evenly spaced on a 25mm wide Press-In Tool.

3. Carefully insert, by hand, the power module(s) into the printed circuit board hole pattern.
4. Place the application tool on top of the power module with the back guide surface of the tool against the back of the power module. See Figure 2-14.
5. Using the application tool and an appropriate press, seat the power module until there is less than 0.10mm (.004 in) clearance between the bottom of the plastic housing and the surface of the printed circuit board. See Figure 2-15.

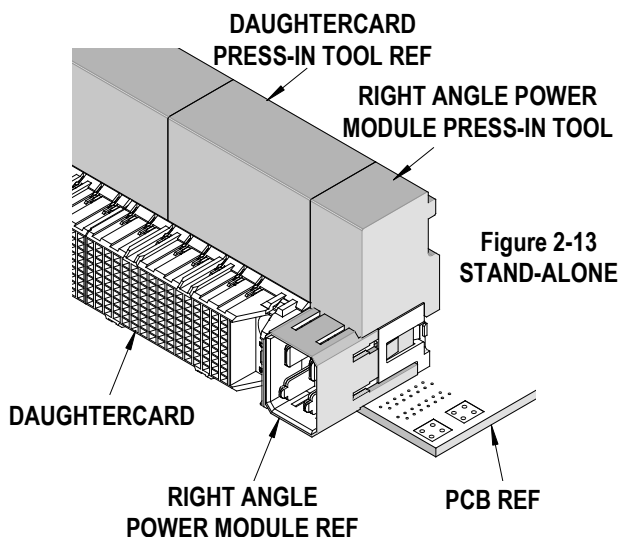

Figure 2-13
STAND-ALONE

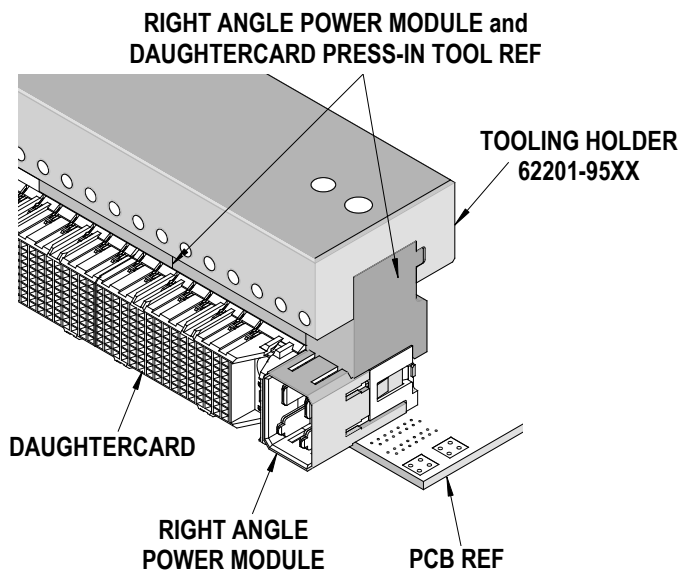

Figure 2-14
Right angle power module is seated along side the Daughtercard signal module.
For ganged power modules, additional power module press-in-tools may be needed; see sales drawings for ganged product dimensions.

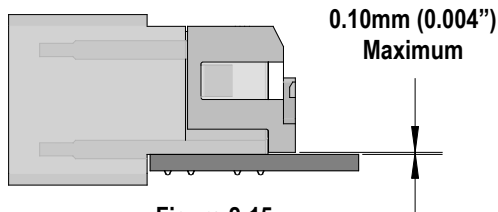

Figure 2-15



CAUTION: To prevent injury, never operate any press without the guards in place. Refer to the press manufacturer's instruction manual.

Section 3

Maintenance

- 3.1 Cleaning
- 3.2 Lubrication
- 3.3 Troubleshooting

3.1. Cleaning

Once a day, the support fixture should be cleaned of dust and plating particles and other debris. Compressed air may be necessary to remove debris from the pin clearance holes.



CAUTION: Use **extreme caution** when using compressed air for cleaning, it can cause debris to get lodged in the tooling or come flying out at the operator. **USE** of proper safety glasses by the operator and onlookers is required.

3.2 Lubrication

There is no lubrication required on any of the Impact™ tooling. However, presses may have their own requirements for lubrication and maintenance. The instruction manual for the specific press being used should be referred to.

3.3 Troubleshooting

Symptom	Cause	Solution
Connector damage	▪ Press stroke set too low.	Refer to the appropriate press manual and adjust the stroke. See Section 2.2
	▪ Connector and/or tooling not properly aligned	Check Fixture and Repair as required.
		Check alignment of fixture in press
	Check to be sure the press platen is pressing squarely on the tooling block.	
	▪ Tooling bent or damaged	Replace tool

Section 4

Available Tools

4.1 Standard Press-In-Tools

Table 4-1 Assembly Tooling for Impact™ Signal and Power Assemblies

Table 4-2 Standard Tool Holders for Molex Press Fit Insertion Tools

Table 4-3 Field Repair Tooling for Impact™ Backplane and Daughtercard Assemblies

4.2 Standard Tool Ordering Procedure

4.1 Standard Press-In-Tools

Standard Insertion Tools

All the applicable Impact™ connectors and the standard tooling required for each connector are located in these tables.

TABLE 4-1





Assembly Tooling (For use in standard tool holder)

Refer to the individual instruction sheets for more information on Individual tools.

Impact™ 100 Ohm Products – Insertion Tools							
Pair	Column	Product	Module Type	Series	Tool	Width	Illustration
2	8	100 Ohm Coplanar	RAM	170026	62201-8851	15.1mm (0.59 In.)	
	10	100 Ohm Conventional	BP	76453 76455 171290	62201-8692	18.8mm (0.74 In.)	
		100 Ohm Coplanar	RAM	76450	62201-8778	18.8mm (0.74 In.)	
		100 Ohm Conventional	DC	76460			
		100 Ohm Coplanar	RAM	170026			
	12	100 Ohm	RAM	76450	62201-8979	22.7mm (0.89 In.)	
	16	100 Ohm Conventional	BP	76453 76455 171290	62201-8694	30.22mm (1.19 In.)	
		100 Ohm Conventional	DC	76460	62201-8779	30.22m (1.19 In.)	
		100 Ohm Coplanar	RAM	76450	62201-8779	30.22m (1.19 In.)	
		100 Ohm Conventional	DC	76460			
		100 Ohm Custom	RAM	170026			
	18	100 Ohm Custom	RAM	170026	62201-8852	34.0mm (1.34 In.)	
3	6	100 Ohm Conventional	BP	76162 76165 171292	62201-8781	11.2mm (0.44 In.)	
		100 Ohm Orthogonal	BP	76855 76856 171344 171345	62203-0460	12.0mm (0.47 In.)	
		100 Ohm Conventional	DC	76170	62201-8780	11.2mm (0.44 In.)	
		100 Ohm Mezzanine	Mezzanine	170415	62201-8859	11.4mm (0.45 In.)	

Impact™ 100 Ohm Products – Insertion Tools							
Pair	Column	Product	Module Type	Series	Tool	Width	Illustration
		100 Ohm Orthogonal	DC	76860	62201-8744	11.80mm (0.46 In.)	
3	6	100 Ohm Ortho Direct	RAM	171573	62203-0026	15.0mm (0.59 In.)	
3	8	100 Ohm Orthogonal	BP	76855 76856 171344	62203-0465	12.0mm (0.47 In.)	
		100 Ohm Conventional	BP	76162 76165 171292	62201-8674	15.0mm (0.59 In.)	
		100 Ohm Conventional	DC	76170	62201-8675	15.0mm (0.59 In.)	
		100 Ohm Coplanar	RAM	76410			
		100 Ohm Mezzanine	Mezzanine	170415	62201-8858	15.2mm (0.60 In.)	
		100 Ohm Orthogonal	DC	76860	62201-8746	15.85mm (0.62 In.)	
3	10	100 Ohm Conventional	BP	76162 76165 171292	62201-8647	18.8mm (0.74 In.)	
		100 Ohm Conventional	DC	76170	62201-8646	18.9mm (0.74 In.)	
		100 Ohm Coplanar	RAM	76410			
		100 Ohm Mezzanine	Mezzanine	170415	62201-8857	19.0mm (0.75 In.)	
3	14	Impact XTR	DC	171180	62201-8868	13.8mm (0.54 In.)	
		100 Ohm Conventional	BP	76162	62201-8853	26.45mm (1.04 In.)	
3	16	100 Ohm Conventional	BP	76162 171292	62201-8651	30.25mm (1.19 In.)	
		100 Ohm Mezzanine	Mezzanine	170415	62201-8856	30.4mm (1.20 In.)	
		100 Ohm Conventional	DC	76170	62201-8650	30.3mm (1.19 In.)	
		100 Ohm Coplanar	RAM	76410			
		100 Ohm Coplanar	RAM	170027			
4	6	100 Ohm Orthogonal	BP	76845 171348	62203-0470	12.0mm (0.47 In.)	

Impact™ 100 Ohm Products – Insertion Tools							
Pair	Column	Product	Module Type	Series	Tool	Width	Illustration
4	6	100 Ohm Conventional	BP	76152 76155 171294	62201-8679	11.2mm (0.44 In.)	
4	6	100 Ohm Conventional	DC	76160	62201-8748	11.75mm (0.46 In.)	
4	6	100 Ohm Orthogonal	DC	76850			
4	8	100 Ohm Orthogonal	BP	76845 76846 171348	62203-0575	16.9mm (0.67 In.)	
		100 Ohm Conventional	BP	76152 76155 171294 171295	62201-8676	15.0mm (0.59 In.)	
		100 Ohm Conventional	BP	76152	62201-8793	15.0mm (0.59 In.)	
		100 Ohm Orthogonal Routable	BP	76849	62201-8678	15.0mm (0.59 In.)	
		100 Ohm Conventional	DC	76160	62201-8677	15.0mm (0.59 In.)	
		100 Ohm Coplanar	RAM	76500			
		100 Ohm Orthogonal	DC	76850			
		100 Ohm Ortho Direct	RAM	76730 171574	62203-0027	20.0mm (0.79 In.)	
4	10	100 Ohm Orthogonal	BP	76845 171348	62203-0475	16.05mm (0.63 In.)	
		100 Ohm Conventional	BP	76152 76155 171294	62201-8640	18.4mm (0.72 In.)	
		100 Ohm Conventional	DC	76160	62201-8641	18.9mm (0.74 In.)	
		100 Ohm Coplanar	RAM	76500			
		100 Ohm Orthogonal	DC	76850			
4	16	100 Ohm Conventional	BP	76152 76155 171294	62201-8644	30.25mm (1.19 In.)	
		100 Ohm Conventional	DC	76160	62201-8645	30.25mm (1.19 In.)	
		100 Ohm Coplanar	RAM	76500			
5	8	100 Ohm Orthogonal	BP	76985 171352	62203-0480	16.05mm (0.63 In.)	
		100 Ohm Orthogonal	DC	76990	62201-8754	18.8mm (0.74 In.)	

Impact™ 100 Ohm Products – Insertion Tools							
Pair	Column	Product	Module Type	Series	Tool	Width	Illustration
		100 Ohm Conventional	BP	76055 171296	62201-8854	15.1mm (0.59 In.)	
5	10	100 Ohm Orthogonal	BP	76985 171352	62203-0580	20.95mm (0.82 In.)	
5	10	100 Ohm Conventional	BP	76055 76163 171296	62201-8658	18.8mm (0.74 In.)	
		100 Ohm Mezzanine	Mezzanine	76530	62201-8695	19.0mm (0.75 In.)	
		100 Ohm Conventional	DC	76060	62201-8657	18.9mm (0.74 In.)	
		100 Ohm Orthogonal		76990			
		100 Ohm Ortho Direct	RAM	76725 171575	62203-0028	22.0mm (0.87 In.)	
5	12	100 Ohm Orthogonal	BP	76985 76986 171352	62203-0585	25.0mm (0.98 In.)	
		100 Ohm Conventional	BP	76163 76055 171296	62201-8708	22.6mm (0.89 In.)	
		100 Ohm Mezzanine	Mezzanine	76530	62201-8860	22.8mm (0.90 In.)	
		100 Ohm Conventional	DC	76060	62201-8735	18.8mm (0.74 In.)	
		100 Ohm Orthogonal		76990			
5	14	100 Ohm Conventional	BP	76055 76163 171296	62201-8783	26.45mm (1.04 In.)	
		100 Ohm Conventional	DC	76060	62201-8782	26.45mm (1.04 In.)	
		100 Ohm Mezzanine	Mezzanine	76530	62201-8861	26.6mm (1.05 In.)	
5	16	100 Ohm Conventional	BP	76055 76163 171293 171296 171297	62201-8665	30.25mm (1.19 In.)	
5	16	100 Ohm Mezzanine	Mezzanine	76530	62201-8696	30.4mm (1.20 In.)	

Impact™ 100 Ohm Products – Insertion Tools							
Pair	Column	Product	Module Type	Series	Tool	Width	Illustration
5	16	100 Ohm Conventional	DC	76060	62201-8659	30.25mm (1.19 In.)	
6	10	100 Ohm Orthogonal	BP	76285 171356	62203-0495	20.95mm (0.82 In.)	
6	10	100 Ohm Conventional	BP	76142 76145 171298	62201-8662	18.8mm (0.74 In.)	
6	10	100 Ohm Conventional	DC	76150	62201-8661	18.8mm (0.74 In.)	
		100 Ohm Orthogonal	DC	76290			
		100 Ohm Coplanar	RAM	76560			
6	12	100 Ohm Orthogonal	BP	76285 76286 171356	62203-0485	25.00mm (0.98 In.)	
		100 Ohm Orthogonal	DC	76290	62201-8762	23.9mm (0.94 In.)	
		100 Ohm Ortho Direct	RAM	76735 171576	62203-0029	26.0mm (1.02 in.)	
6	14	100 Ohm Conventional	BP	76142 76145 171298	62201-8639	26.5mm (1.04 In.)	
		100 Ohm Conventional	DC	76150	62201-8698	18.8mm (0.74 In.)	
		100 Ohm Coplanar	RAM	76560			
6	16	100 Ohm Conventional	BP	76142	62201-8855	30.25mm (1.19 In.)	
		100 Ohm Conventional	BP	76145 171298	62201-8664	30.25mm (1.19 In.)	
		100 Ohm Conventional	DC	76150	62201-8663	30.25mm (1.19 In.)	
		100 Ohm Coplanar	RAM	76560			

Impact™ 85 Ohm Plus Products – Insertion Tools							
Pair	Column	Product	Module Type	Series	Tool	Width	Illustration
2	8	85 Ohm Plus Conventional	BP	171065	62201-8841	15.05mm (0.59 In.)	
2	10	85 Ohm Plus Conventional	BP	171065	62201-8844	18.8mm (0.74 In.)	
		85 Ohm Plus Conventional	DC	76460	62201-8778	18.9mm (0.74 In.)	
2	16	85 Ohm Plus Conventional	DC	76460	62201-8779	30.3mm (1.19 In.)	
2	16	85 Ohm Plus Conventional	BP	171065	62201-8847	30.3mm (1.19 In.)	
3	8	85 Ohm Plus Conventional	BP	170513 170522 170525	62201-8801	15.0mm (0.59 In.)	
		85 Ohm Plus Conventional	DC	170530	62201-8675	15.0mm (0.59 In.)	
3	10	85 Ohm Plus Conventional	BP	170513 170522 170525	62201-8813	18.9mm (0.74 In.)	
		85 Ohm Plus Conventional	DC	170530	62201-8646	18.9mm (0.74 In.)	
3	16	85 Ohm Plus Conventional	BP	170513 170522 170525	62201-8816	30.25m (1.19 In.)	
		85 Ohm Plus Conventional	DC	170530	62201-8650	30.3mm (1.19 In.)	
4	6	85 Ohm Plus Conventional	BP	170335	62201-8869	15.0mm (0.59 In.)	
4	8	85 Ohm Plus Conventional	BP	170335 170515	62201-8787	15.0mm (0.59 In.)	
		85 Ohm Plus Conventional	DC	170340	62201-8677	15.0mm (0.59 In.)	
		85 Ohm Plus Mezzanine	Mezzanine	170390	62201-8863	15.2mm (0.60 In.)	
4	10	85 Ohm Plus Mezzanine	Mezzanine	170390	62201-8717	19.0mm (0.75 In.)	

Impact™ 85 Ohm Plus Products – Insertion Tools							
Pair	Column	Product	Module Type	Series	Tool	Width	Illustration
4	10	85 Ohm Plus Conventional	BP	170332 170335 170515	62201-8790	18.8mm (0.74 In.)	
4	10	85 Ohm Plus Conventional	DC	170340	62201-8641	18.9mm (0.74 In.)	
4	12	85 Ohm Plus Mezzanine	Mezzanine	170390	62201-8864	22.8mm (0.9 In.)	
4	12	85 Ohm Plus Conventional	BP	170335 170515	62201-8833	22.7mm (0.89 In.)	
4	12	85 Ohm Plus Conventional	DC	170340	62201-8839	22.7mm (0.89 In.)	
4	14	85 Ohm Plus Mezzanine	Mezzanine	170390	62201-8865	26.6mm (1.05 In.)	
		85 Ohm Plus Conventional	BP	170335 170515	62201-8836	26.5mm (1.04 In.)	
		85 Ohm Plus Conventional	DC	170340	62201-8840	26.46mm (1.04 In.)	
4	16	85 Ohm Plus Mezzanine	Mezzanine	170390	62201-8866	30.4mm (1.20 In.)	
		85 Ohm Plus Conventional	BP	170332 170335 170515	62201-8826	30.25mm (1.19 In.)	
		85 Ohm Plus Conventional	DC	170340	62201-8645	30.25mm (1.19 In.)	
4	18	85 Ohm Plus Conventional	BP	170332	62201-8784	34.1mm (1.34 In.)	
		85 Ohm Plus Mezzanine	Mezzanine	170390	62201-8718	34.0mm (1.34 In.)	
5	10	OLD 85 Ohm Conventional	BP	76772 76775	62201-8731	18.8mm (0.74 In.)	
		85 Ohm Plus Conventional	BP	170475 170517	62201-8821	18.8mm (0.74 In.)	
		OLD 85 Ohm Conventional	DC	76780	62201-8657	18.9mm (0.74 In.)	
		85 Ohm Plus Conventional		170480			

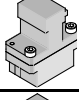
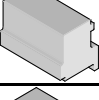
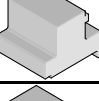
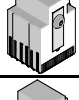
Impact™ 85 Ohm Plus Products – Insertion Tools							
Pair	Column	Product	Module Type	Series	Tool	Width	Illustration
5	12	85 Ohm Plus Conventional	BP	170472 170475 170517 170518	62201-8804	22.7mm (0.89 In.)	
		85 Ohm Plus Conventional	DC	170480	62201-8735	18.8mm (0.74 In.)	
5	16	OLD 85 Ohm Conventional	BP	76772 76775	62201-8701	30.25mm (1.19 In.)	
5	16	85 Ohm Plus Conventional	BP	170475 170517	62201-8824	30.25mm (1.19 In.)	
5	16	OLD 85 Ohm Conventional	DC	76780	62201-8659	30.25mm (1.19 In.)	
5	16	85 Ohm Plus Conventional		170480			
6	8	85 Ohm Plus Conventional	BP	170535	62201-8882	15.05mm (0.593 In.)	
6	10	85 Ohm Plus Conventional	BP	170519 170535	62201-8807	18.8mm (0.74 In.)	
		85 Ohm Plus Orthogonal	BP	171415	62203-0900	TBD	
		85 Ohm Plus Conventional	DC	170540	62201-8862	18.9mm (0.74 In.)	
		85 Ohm Plus Orthogonal	DC	171420	62201-8867	19.8mm (0.78 In.)	
6	12	85 Ohm Plus Orthogonal	DC	171420	62201-8762	23.9mm (0.94 In.)	
		85 Ohm Plus Orthogonal	BP	171415	62201-8850	25mm (0.98 In.)	
6	14	85 Ohm Plus Conventional	BP	170535	62201-8876	26.5mm (1.04 In.)	
6	16	85 Ohm Plus Conventional	BP	170519 170520 170532 170535	62201-8810	30.25mm (1.19 In.)	
		85 Ohm Plus Conventional	DC	170540	62201-8663	30.25mm (1.19 In.)	



Impact™ Power Modules – Insertion Tools						
Pair	Product	Module Type	Series	Tool	Width	Illustration
3	Power	Right Angle Header	78211	62201-8649	11.0mm (0.43 In.)	
		Right Angle Header	78347			
		Right Angle Receptacle	78348			
		Vertical Receptacle	78212	62201-8648	18.2mm (0.72 In.)	
		Vertical Plug	78399	62201-8687	11.0mm (0.43 In.)	
4	Power	Right Angle Header	78213 78659	62201-8642	11.0mm (0.43 In.)	
		Right Angle Receptacle	78248 78666			
		Right Angle Header	78349 78671			
		Right Angle Receptacle	78350			
		Right Angle Header	78451 78672	62201-8643	15.0mm (0.59 In.)	
		Vertical Receptacle	78214			
5	Power	Right Angle Header	78215 78351 78352	62201-8668	11.0mm (0.43 In.)	
		Vertical Receptacle	78216	62201-8667	15.0mm (0.59 In.)	
		Vertical Header	78446 78679 78692	62201-8697	11.0mm (0.43 In.)	
6	Power	Right Angle Header	78217 78353 78217	62201-8669	11.0mm (0.43 In.)	
		Vertical Receptacle	78218	62201-8666	15.0mm (0.59 In.)	
		Vertical Header	78442	62201-8689	11.0mm (0.43 In.)	

TABLE 4-2
Standard Tool Holders for Molex Press Fit Insertion Tools





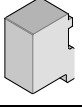
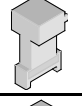
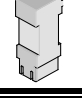
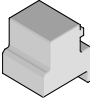
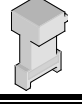
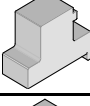
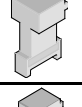
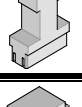
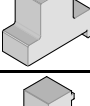
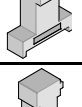





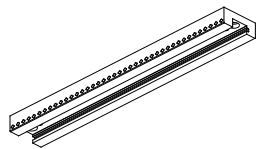

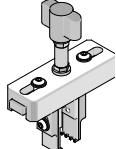
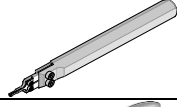
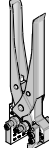
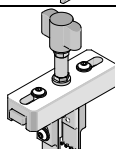
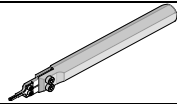

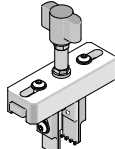
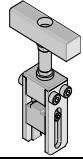
Tool Description	Holder Length	Illustration
Tool Holder 62201-9501	24.0mm (0.94 In.)	
Tool Holder 62201-9502	72.0mm (2.83 In.)	
Tool Holder 62201-9503	156.0mm (6.14 In.)	
Tool Holder 62201-9504	216.0mm (8.50 In.)	
Tool Holder 62201-9509	254.0mm (10.0 In.)	
Tool Holder 62201-9511	304.8mm (12.0 In.)	
Tool Holder 62201-9512	406.4mm (16.0 In.)	

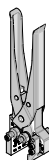
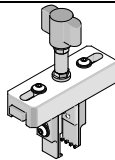
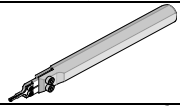
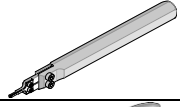
TABLE 4-3
Field Repair Tooling for Impact™ Signal and Power Assemblies

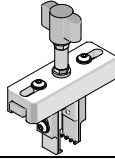
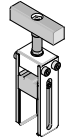
Impact™ 85 Ohm, 100 Ohm, and Power Products – Repair Tools						
Pair	Product	Module Type	Series	Tool	Illustration	
2	100 Ohm Conventional	DC	76460	62202-4300 Extractor		
	100 Ohm Coplanar	RAM	76450	62202-4350 Extractor		
	100 Ohm Conventional	BP	76455	62100-9610 Extractor		
				62100-5800 Signal Pin Inserter		
				Pliers for Pin Removal: Newark 96F8903 MSC 00321885		
3	100 Ohm Conventional	DC	76170	62202-4600 Extractor		
	100 Ohm Orthogonal		76860			
	85 Ohm plus Conventional		170530			
	100 Ohm Coplanar	RAM	76410	62202-4350 Extractor		
3	100 Ohm Conventional	BP	76165	62100-9610 Extractor		
	85 Ohm Plus Conventional		170513 170522 170525			
	85 Ohm Plus Conventional		BP			170513 170522 170525
3	100 Ohm Conventional	BP	76162 76165 171292	62100-5800 Signal Pin Inserter		

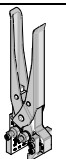
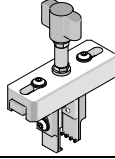
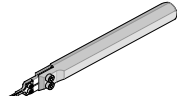
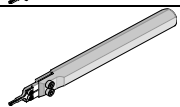
Impact™ 85 Ohm, 100 Ohm, and Power Products – Repair Tools					
Pair	Product	Module Type	Series	Tool	Illustration
				Pliers for Pin Removal: Newark 96F8903 or MSC 00321885	
	100 Ohm Orthogonal	BP	76855 76856 171344 171345	62100-9620 Extractor	
3	Power	Vertical Header	78399	62100-8000 Extractor	
		Vertical Receptacle	78212	62100-8300 Extractor	
		Right Angle Header	78211 78347	62202-4500 Extractor	
4	100 Ohm Conventional	DC	76160	62202-4300 Extractor	
	100 Ohm Orthogonal		76850		
	85 Ohm plus Conventional		170340 171574		
	100 Ohm Coplanar	RAM	76500	62202-4350 Extractor	
	100 Ohm Conventional	BP	76152, 76155 171294	62100-9610 Extractor	
	85 Ohm Plus Conventional		170332, 170335 170515		
	85 Ohm Plus Conventional	BP	170332 170335 170515	62100-5850 Signal Pin Inserter	
4	100 Ohm Conventional	BP	76152, 76155, 171294, 76152, 76155, 171294	62100-5800 Signal Pin Inserter	
				Pliers for Pin Removal: Newark 96F8903 or MSC 00321885	
	100 Ohm Orthogonal	BP	76845	62100-9620 Extractor	
	85 Ohm PLUS Conventional	Mezzanine (18mm height)	170390	62100-2150 Extractor	
		Mezzanine (37mm height)		62100-2180 Extractor	
				62100-2100 Extractor	
4	Power	Right Angle Header	78213 78349	62202-4500 Extractor	

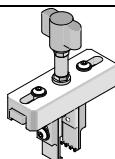
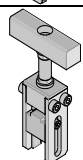
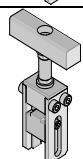
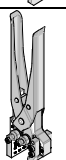
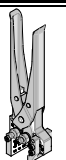
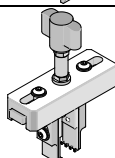
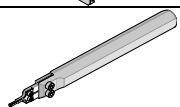
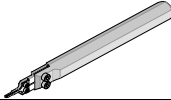
Impact™ 85 Ohm, 100 Ohm, and Power Products – Repair Tools					
Pair	Product	Module Type	Series	Tool	Illustration
5	100 Ohm Conventional	DC	76060	62202-4300 Extractor	
	100 Ohm Orthogonal		76990		
	85 Ohm plus Conventional		170480		
5	100 Ohm Conventional	BP	76055, 76163 171293, 171296, 171297	62100-9610 Extractor	
	85 Ohm Plus Conventional		170472, 170475, 170517, 170518		
	85 Ohm Plus Conventional	BP	170472, 170475, 170517, 170518	62100-5850 Signal Pin Inserter	
5	100 Ohm Conventional	BP	76055, 76163, 171293, 171296, 171297	62100-5800 Signal Pin Inserter	
				Pliers for Pin Removal: Newark 96F8903 or MSC 00321885	
5	100 Ohm Orthogonal	BP	76985 76986 171352	62100-9620 Extractor	
	100 Ohm Conventional	Mezzanine (37mm height)	76530	62100-2170 Extractor	
5	Power	Vertical Header	78446, 78692	62100-8200 Extractor	
		Vertical Receptacle	78216		
		Right Angle Header	78215 78351	62202-4500 Extractor	
6	100 Ohm Conventional	DC	76150	62202-4300 Extractor	
	100 Ohm Orthogonal		76290		
	85 Ohm plus Conventional		170540		
	100 Ohm Coplanar	RAM	76560	62202-4350 Extractor	
	100 Ohm Conventional	BP	76142, 76145, 171298	62100-9610 Extractor	
	85 Ohm Plus Conventional		170519, 170520, 170532, 170535		
85 Ohm Plus Conventional	BP	170519, 170520, 170532, 170535	62100-5850 Signal Pin Inserter		

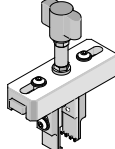
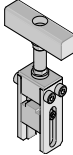
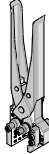
Impact™ 85 Ohm, 100 Ohm, and Power Products – Repair Tools					
Pair	Product	Module Type	Series	Tool	Illustration
6	100 Ohm Conventional	BP	76142 76145 171298	62100-5800 Signal Pin Inserter	
				Pliers for Pin Removal: Newark 96F8903 or MSC 00321885	
	100 Ohm Orthogonal	BP	76285 76286 171356	62100-9620 Extractor	
6	Power	Vertical Header	78442	62100-8200 Extractor	
		Vertical Receptacle	78218		
		Right Angle Header	78353	62202-4500 Extractor	

4.2 Standard Tool Ordering Procedure

Stacking Tooling

All the insertion tooling listed in Table 4-1 can be stacked in any combination to be able to simultaneously press in any arrangement of stacked connectors. Tooling holders are available in various lengths. Figure 4-1 shows a typical setup for a 4 pair by 8 column backplane signal module in a standard tool holder.

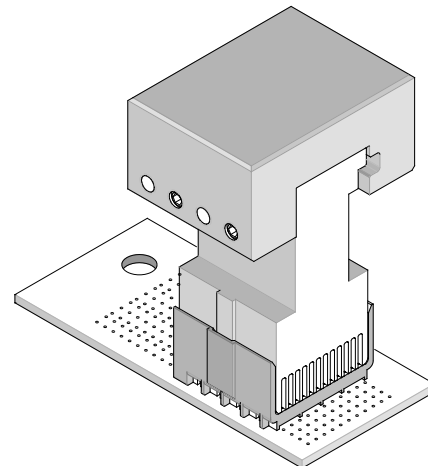

Figure 4-1
TYPICAL INSERTION
TOOL ASSEMBLY

Ordering Insertion Tooling for Backplane Connectors

In order to insert a typical row of backplane connectors, it is necessary to select the individual insertion tools and then pick the appropriate tooling holder (See example).

Basic Procedure



CAUTION: The vertical power module must be installed separately without any backplane or daughtercard assemblies in the combinations.

1. Determine the combination of signal modules to be inserted.
2. Select the proper press-in tools from Table 4-1 and Table 4-2.
3. Table 4-1 and Table 4-2 shows the tool widths. Record the width of each tool selected.

NOTE: Make sure that if you require four of a particular tool, write down its length 4 times.

4. Total up the tool widths.
5. Using the width just calculated, select the next largest tooling holder from Table 4-3. The tooling holder can be shorter than the total tooling but not by more than 0.5 mm per side.
6. The insertion tools and tooling holder selected above must be ordered separately.

Ordering Daughtercard Tooling

Daughtercard connectors only come in standard module sizes. The Daughtercard insertion modules lengths are based on the module size. Therefore, insertion tools can be used individually for a connector assembly or stacked in a tool holder for multiple connector assemblies. Select the specific tool for your connector from Table 4-3.

Section 5

Repair and Replacement

- 5.1 Backplane Repair Procedure
- 5.2 Daughtercard Repair Procedure
- 5.3 Glossary of Terms

5.1 Impact™ Backplane Repair Procedure:

Removal and Replacement of Signal Pair Pins

The following tools are required:

- ✓ Signal Pin Replacement Tool 62100-5800 (100 Ohm)
- ✓ Signal Pin Replacement Tool 62100-5850 (85 Ohm)
- ✓ Needle nose pliers (miniature) *
- ✓ Tweezers *

* Not supplied by Molex

Removal

To remove damaged signal pins, grasp them with the needle nose pliers and pull straight up from the board. See Figure 5-1. In some cases it may be necessary to straighten a bent pin with the tweezers to allow access with the pliers.

NOTE: Never reuse a backplane signal pin once it has been removed. In addition, no more than three pins should be pressed into any plated through hole. Replacement pins should be removed from a spare virgin connector.

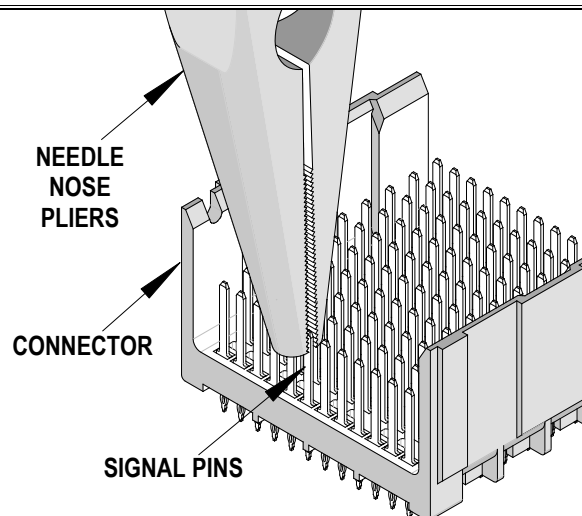

FIGURE 5-1

Replacement

1. Place the replacement signal contact at the tip of the insertion tool and slide the contact so it rests underneath the terminal clamp. See Figure 5-2.

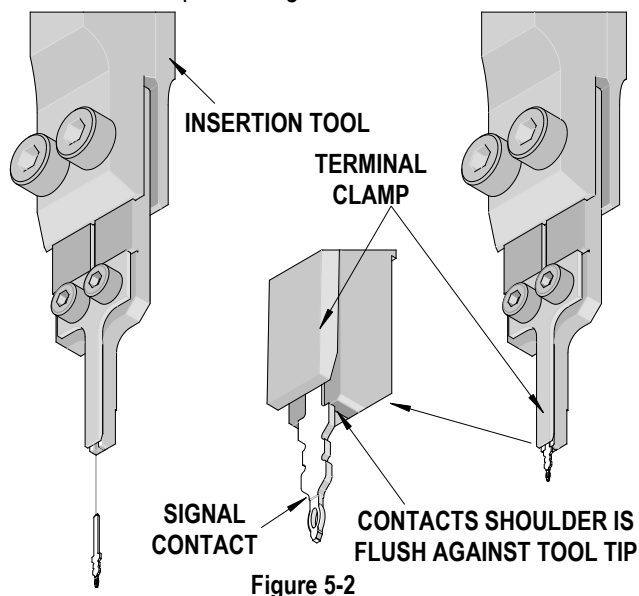

Figure 5-2

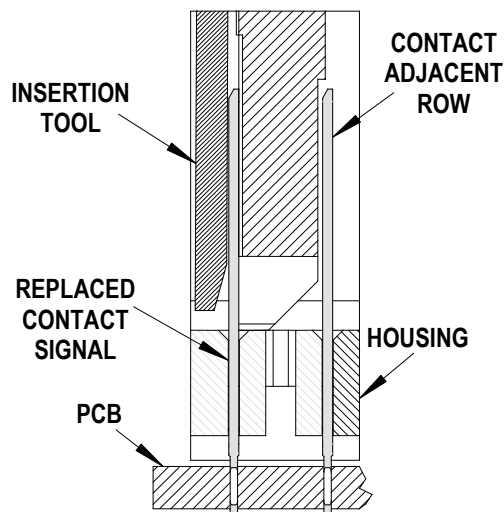

Figure 5-3

2. The signal contact will be guided using the groove located on the insertion tool and should be pushed all the way underneath the terminal clamp.
3. The signal contact is completely seated in the insertion tool when, the contacts shoulder is resting against the insertion tool tip and can no longer be moved up.
4. Make sure the signal contact is in the correct orientation. Check the column where the repair signal contact is being replaced and compare the column to the contact signal on the insertion tool. The two should be the same. The adjacent column is oriented in the opposite direction. See Figure 5-3.
5. Line-up the pins tip on the signal contact, with the hole in the signal module and push the pin tip with the insertion tool through the housing and the printed circuit board.

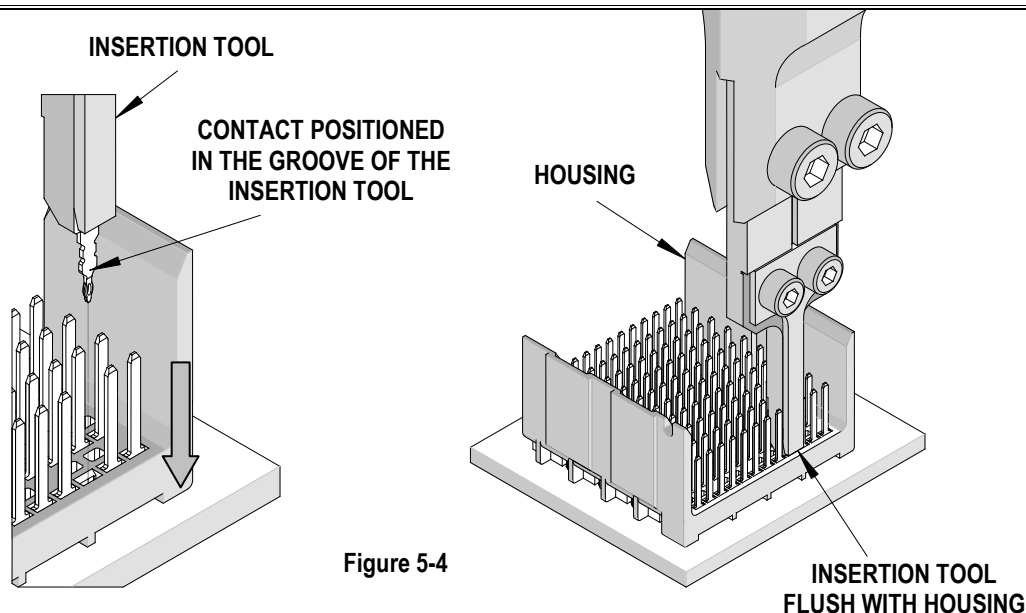

Figure 5-4

6. There is a clearance groove on the opposite side of the tool. When inserting the signal contact, make sure the adjacent row is positioned in this groove.
7. Continue pushing the signal contact until the insertion tool and terminal shoulder are seated securely to the inside housing surface. See Figure 5-4.
8. Pull the insertion tool straight up and remove. Check the final seating of the signal contact, the terminal shoulder should be seated flush with inside surface on housing.

Impact™ Daughtercard Repair Procedure

The following tools are required:

- ✓ Module Removal Tool 62202-4300
- ✓ Pallet to support Printed circuit board *
- ✓ Small arbor press (optional)*

*Not supplied by Molex

Connector Removal

Before removing the DaughterCard Signal Module from the printed circuit board, the rows of the module have to be determined. This is required so the Removal tool jaws can be set-up correctly to match the proper DaughterCard Row Series. Count the number of rows on the Front Wafer Housing. See ATS-62202-4300 for tool set up.

OPERATING SPACE (Keep Out Zone)

A certain amount of space is required on the printed circuit board for the Removal Tool to fit over the daughtercard signal module. Make sure there are no other components in this space. See Figure 5-6.

1. Before removing individual modules be certain the tool is adjusted to the correct row size. See Figure 5-7.

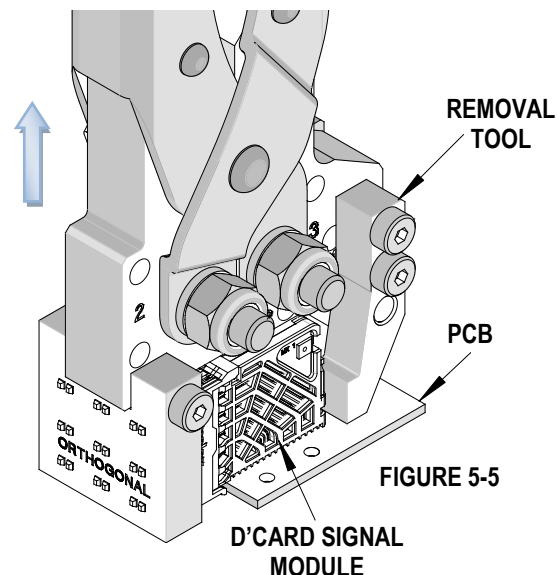

FIGURE 5-5

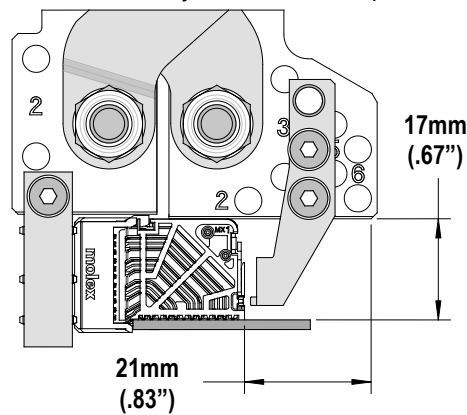
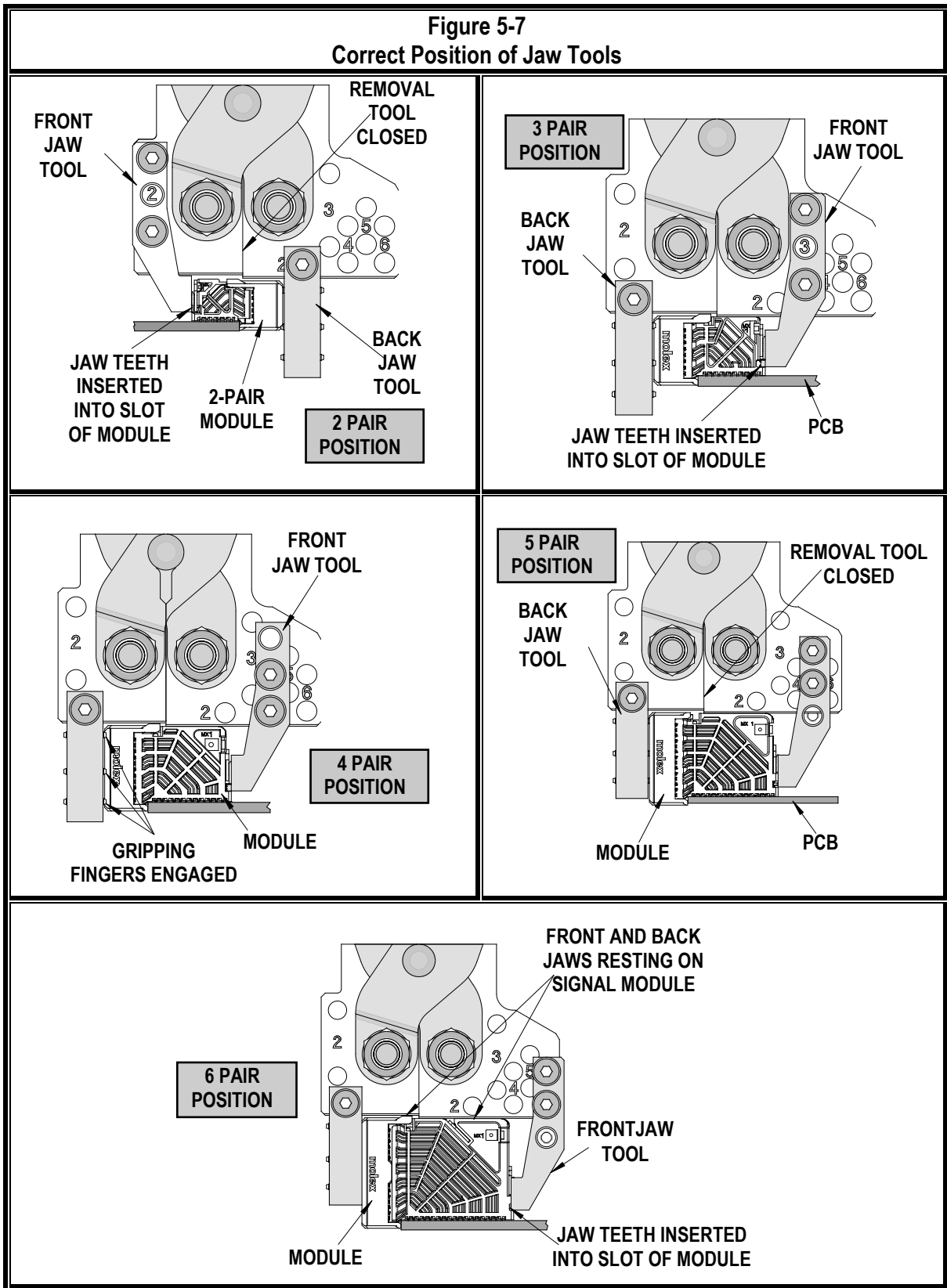

Figure 5-6



2. Position the 62202-4300 Removal Tool over the defective module with the toothed jaw located over the mating end of the connector and the slotted jaw over the stiffener on the opposite end of the module.
3. While holding the tool in position over the module, squeeze the handles until the jaws clamp firmly. While applying pressure to the handles, pull straight up until the connector comes off the board.

Backplane Module Replacement

Follow operation instruction from section 2.4.

Power Module Removal

Daughtercard power modules should be removed using the 62200-4500 pliers. Clamp the pliers over the mating and stiffener side of the module and pull up. Be careful of any adjacent signal modules while removing the powers. See Table 4-3 for vertical power module removal tools.

Power Module Replacement

Follow operation instructions from section 2.4.

5.2 Glossary of Terms:

Backup (or Support) Pallet	A simple fixture used to locate and support a printed circuit while a compliant pin connector is being pressed into the pc board. Considerable force is required to press one of these connectors into a pc board, thus the pc board must be adequately supported to avoid being damaged. It must have adequate clearance for the terminals when they protrude through the pc board.
Compliant Pin Connector	A connector which has terminals that are designed to give slightly when pressed into a hole in a pc board so that the terminal (pin) makes solid electrical contact with the printed circuit board, alleviating the need for soldering.
Flat Platen Press	A press in which the upper tooling or die set is not attached to the press ram. The ram has a simple flat plate (or platen) attached to it. For this application, the upper tooling is positioned in the connector(s). The press ram comes down on top this tooling and presses on it. When the press ram goes back up, the upper tooling stays with the connector.
PCB	Abbreviation for printed circuit board
Upper Tooling	The tooling that goes on top of the connector. It contains the mounting block and dies (or tools) necessary to properly apply pressure where required to push the connector's compliant terminals and locking posts into the holes in the printed circuit board.

Visit our Web site at <http://www.molex.com>