

PH5553A2NA1

Data Sheet
 R08DS0068EJ0100
 Rev.1.00
 Nov 07, 2012

Ambient Light Sensor

DESCRIPTION

The PH5553A2NA1 is a digital ambient light sensor for I²C bus interfaces and includes a 16-bit AD converter. This product has spectral characteristics close to human eye sensitivity and outputs digital signals corresponding to the ambient brightness.

The PH5553A2NA1 can be used to improve the performance and reduce the power consumption of digital equipment such as FPD TV sets and mobile phones, by enabling automatic brightness control and automatic switching on and off of lighting systems.

FEATURES

- Small and thin SON package 2.55 x 1.56 x 0.55 mm
- Built-in 16-bit AD converter
- I²C bus interface 1.8 V reference supply voltage
- Spectral characteristics close to human eye sensitivity
 Peak sensitivity wavelength 550 nm TYP.
- Light source dependence with mounting the device can be reduced by the spectral characteristics adjustment function from visible region to infrared region.
- The calculation after illuminance output is not necessary by selecting the spectral characteristics from 16 patterns of those.
- Illuminance detection of wide region can be realized.

Minimum detectable illuminance	0.1 lx
Maximum detectable illuminance	65 535 lx
- Pb-free

APPLICATIONS

- FPD TV sets, displays
- Mobile phones, smartphones
- Notebook PCs, tablet PCs
- DSCs, DVCs
- FA equipment
- Lighting systems, etc.

PACKAGE DIMENSIONS (UNIT: mm)

TOP VIEW

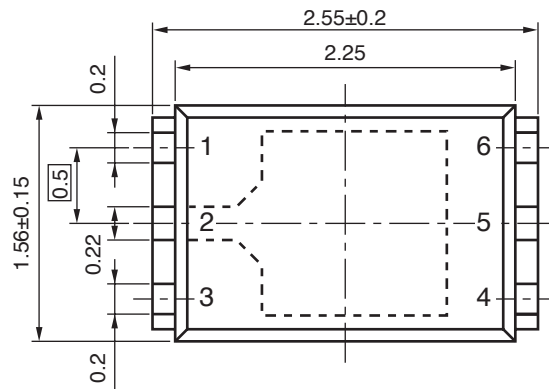

Remark Pin 1 is distinguishable by the shape of the lead frame.

SIDE VIEW

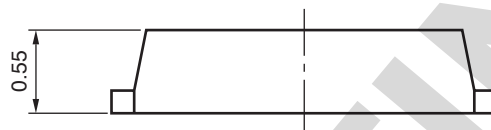

BOTTOM VIEW

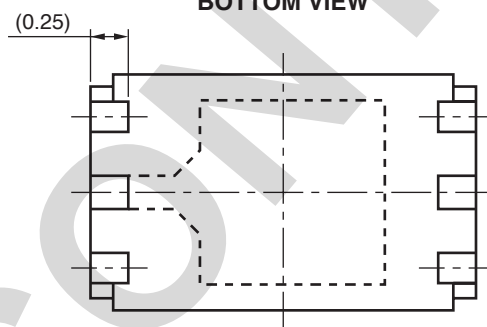

Remark () indicates nominal dimensions.

Pin No.	Terminal	I/O	Function
1	V _{DD}	-	Supply Voltage
2	GND	-	GND
3	V _{IO}	-	I ² C bus interface reference supply voltage
4	SCL	I	I ² C bus SCL
5	TEST	-	Test (Be sure to connect to GND.)
6	SDA	IO	I ² C bus SDA

MARKING

(Bottom View)

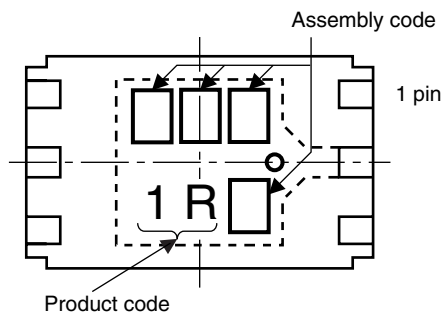

ORDERING INFORMATION

Part Number	Order Number	Solder Plating Specification	Packing Style
PH5553A2NA1-E4	PH5553A2NA1-E4-Y-A	Pb-Free	Embossed Tape 5 000 pcs/reel

ABSOLUTE MAXIMUM RATINGS (T_A = 25°C, unless otherwise specified)

Parameter	Symbol	Ratings	Unit
Supply Voltage	V _{DD}	4.5	V
I ² C Reference Voltage	V _{IO}	V _{DD}	V
Power Dissipation ^{*1}	P _D	135	mW
Operating Temperature	T _A	-30 to +85	°C
Storage Temperature	T _{stg}	-40 to +100	°C

Note: *1. Mounted on glass epoxy board (18 mm × 13 mm × 1.6 mm)

RECOMMENDED OPERATING CONDITIONS

Parameter	Symbol	MIN.	TYP.	MAX.	Unit
Supply Voltage	V _{DD}	2.4	3.0	3.6	V
I ² C Reference Voltage	V _{IO}	1.65	–	V _{DD}	V

ELECTRO-OPTICAL CHARACTERISTICS

($T_A = 25^\circ\text{C}$, $V_{DD} = 3.0\text{ V}$, $V_{IO} = 1.8\text{ V}$, unless otherwise specified)

Parameter	Symbol	Conditions	MIN.	TYP.	MAX.	Unit
Supply Current 1	I_{DD1}	$E_v = 100\text{ lx}^{*1}$		130	290	μA
Supply Current 2	I_{DD2}	$E_v = 100\text{ lx}^{*1}$, power-down		0.01	1	μA
Peak Sensitivity Wavelength	λ_p	PD bit = "1000"		550		nm
Dark Sensor Output	–	$E_v = 0\text{ lx}$, PD bit = "1000", GCSW bit = 1			4	count
Illuminance Count	–	$E_v = 1\,000\text{ lx}^{*1}$, PD bit = "1000", GCSW bit = 1	700	1\,000	1\,300	count
Multiplying Factor of Illuminance Count ($\times 1$)	GCL	PD bit = "1000", GCSW bit = 1, RSLTN bit = 0		1		count/lx
Multiplying Factor of Illuminance Count ($\times 10$)	GCL	PD bit = "1000", GCSW bit = 0, RSLTN bit = 0		10		count/lx
H-Resolution Mode Resolution	HRM	GCSW bit = 1, RSLTN bit = 0		1		count
L-Resolution Mode Resolution	LRM	GCSW bit = 1, RSLTN bit = 1		16		count
Measurement Time in H-Resolution Mode	HRt	RSLTN bit = 0		330	495	ms
Measurement Time in L-Resolution Mode	LRt	RSLTN bit = 1		21	32	ms
I ² C SCL Clock Frequency	f_{SCL}				400	kHz
I ² C Bus Free Time	t_{BUF}		1.3			μs
I ² C Hold Time for START Condition	t_{HDSTA}		0.6			μs
I ² C Set-up Time for START Condition	t_{SUSTA}		0.6			μs
I ² C Set-up Time for STOP Condition	t_{SUSTO}		0.6			μs
I ² C Data Hold Time	t_{HDDAT}		0		0.9	μs
I ² C Data Set-up Time	t_{SUDAT}		100			ns
I ² C 'L' Period of the SCL Clock	t_{LOW}		1.3			μs
I ² C 'H' Period of the SCL Clock	t_{HIGH}		0.6			μs
I ² C 'L' Output Voltage 1 at SDA	V_{OL1}	$V_{IO} > 2\text{V}$, $I_{IO} = 3\text{mA}$	0		0.4	V
I ² C 'L' Output Voltage 2 at SDA	V_{OL2}	$V_{IO} \leq 2\text{V}$, $I_{IO} = 2\text{mA}$	0		$0.2 \times V_{IO}$	V
I ² C 'L' Input Voltage at SCL, SDA	V_{IL}		–0.5		$0.3 \times V_{IO}$	V
I ² C 'H' Input Voltage at SCL, SDA	V_{IH}		$0.7 \times V_{IO}$	–	V_{IO}	V

Note: *1 Fluorescent light

I²C BUS INTERFACE SPECIFICATION

1. I²C Bus Interface Timing Chart

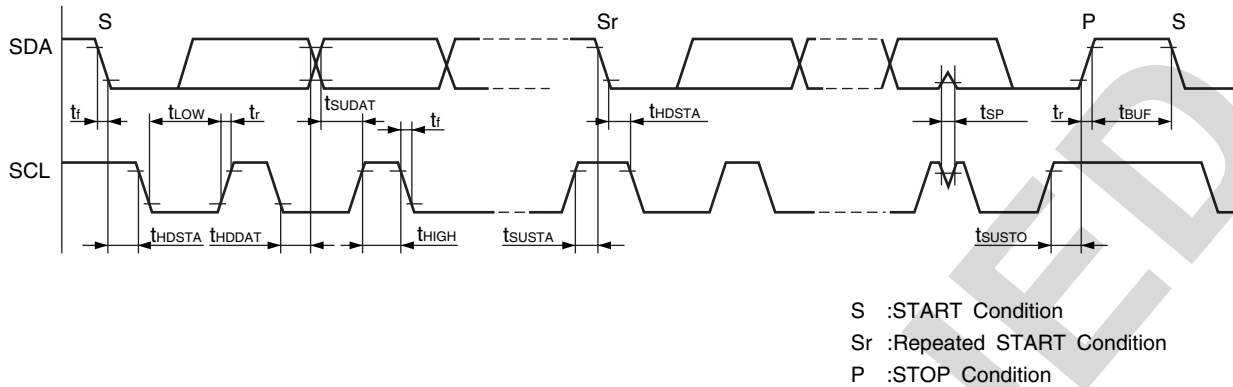

2. Slave Address

"1100100".

3. I²C Protocols

(1) Write Format

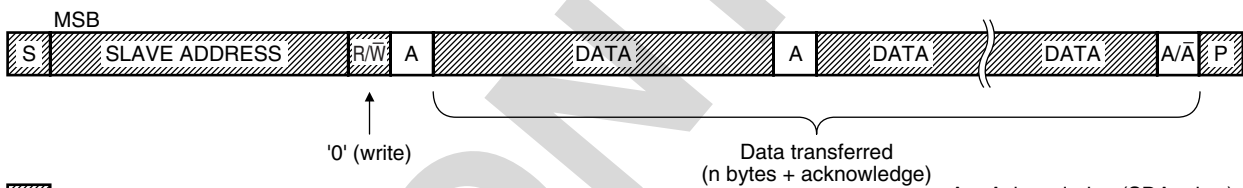

From master to slave
 From slave to master

A = Acknowledge (SDA = low)
 \bar{A} = Not Acknowledge (SDA = high)
 S = START Condition
 P = STOP Condition

(2) Read Format

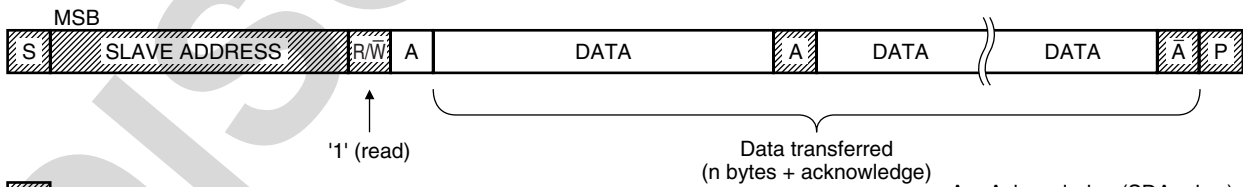

From master to slave
 From slave to master

A = Acknowledge (SDA = low)
 \bar{A} = Not Acknowledge (SDA = high)
 S = START Condition
 P = STOP Condition

REGISTER MAP

1. Set values with Write operation

(a) Register1

0	0	0	0	0	0	0	0	default
Bit 7	Bit 6	Bit 5	Bit 4	Bit 3	Bit 2	Bit 1	Bit 0	
Timemanu	Register Address		SWRST	STOP	RSLTN	GCSW	PWR	

(b) Register2

0	0	0	0	1	0	0	0	default
Bit 15	Bit 14	Bit 13	Bit 12	Bit 11	Bit 10	Bit 9	Bit 8	
0 (fixed)	Reserved	Reserved	Reserved	PD4	PD3	PD2	PD1	

- 1) Timemanu : Measurement time manual set (1: Enable measurement time set by Register3 and Register4)
- 2) Register Address : Register address set during read operation
- 3) SWRST : Register reset (Initial values are restored by setting this bit to 1.)
- 4) STOP : Stops lux measurement after the current ADC cycle. The lux data measured last is retained. The ADC enters standby mode (1: Stop)
- 5) RSLTN : Illuminance count resolution selection (1: 16 count resolution, 0: 1 count resolution)
- 6) GCSW : Illuminance count gain selection (1: 1 count/lx, 0: 10 count/lx)
- 7) PWR : Power control switch (1: Power on, 0: Power off (standby state))
- 8) PD1 to PD4 : Spectral characteristics adjustment

2. Set values with Write Operation (Control with 4 Byte Unit (When Timemanu = 1))

When Timemanu = 1, measurement time is enabled to be changed by transferring Register1 and Register2 followed by Register3 and Register4.

(a) Register3 (when RSLTN = 0)

0	1	0	1	0	0	0	0	default
Bit 7	Bit 6	Bit 5	Bit 4	Bit 3	Bit 2	Bit 1	Bit 0	
Illuminance measurement time counter 0H in H-Resolution mode lower 8 bit (when RSLTN = 0)								

(b) Register4 (when RSLTN = 0)

1	1	0	0	0	0	1	1	default
Bit 15	Bit 14	Bit 13	Bit 12	Bit 11	Bit 10	Bit 9	Bit 8	
Illuminance measurement time counter 1H in H-Resolution mode upper 8 bit (when RSLTN = 0)								

(c) Register3 (when RSLTN = 1)

0	0	1	1	0	1	0	1	default
Bit 7	Bit 6	Bit 5	Bit 4	Bit 3	Bit 2	Bit 1	Bit 0	
Illuminance measurement time counter 2H in L-Resolution mode lower 8 bit (when RSLTN = 1)								

(d) Register4 (when RSLTN = 1)

0	0	0	0	1	1	0	0	default
Bit 15	Bit 14	Bit 13	Bit 12	Bit 11	Bit 10	Bit 9	Bit 8	
Illuminance measurement time counter 3H in L-Resolution mode upper 8 bit (when RSLTN = 1)								

Method for obtaining measurement time

$$\text{Measurement time (ms)} = \text{Set value} / 600 \times 4$$

3. Return Value during Read Operation (When Register Address = 00)

0	0	0	0	0	0	0	0	default
Bit 7	Bit 6	Bit 5	Bit 4	Bit 3	Bit 2	Bit 1	Bit 0	
Illuminance count measurements Upper 8bits								

0	0	0	0	0	0	0	0	default
Bit 15	Bit 14	Bit 13	Bit 12	Bit 11	Bit 10	Bit 9	Bit 8	
Illuminance count measurements Upper 8bits								

4. Return Value during Read Operation (When Register Address = 01)

0	0	0	0	0	0	0	0	default
Bit 7	Bit 6	Bit 5	Bit 4	Bit 3	Bit 2	Bit 1	Bit 0	
Timemanu	Register Address	SWRST	STOP	RSLTN	GCSW	PWR		

0	0	0	0	1	0	0	0	default
Bit 15	Bit 14	Bit 13	Bit 12	Bit 11	Bit 10	Bit 9	Bit 8	
0 (fixed)	Reserved	Reserved	Reserved	PD4	PD3	PD2	PD1	

5. Return Value during Read Operation (When Register Address = 10)

Bit 7	Bit 6	Bit 5	Bit 4	Bit 3	Bit 2	Bit 1	Bit 0
Illuminance measurement time counter 0H in H-Resolution mode lower 8 bit (when RSLTN = 0)							
Illuminance measurement time counter 2H in L-Resolution mode lower 8 bit (when RSLTN = 1)							

Bit 15	Bit 14	Bit 13	Bit 12	Bit 11	Bit 10	Bit 9	Bit 8
Illuminance measurement time counter 1H in H-Resolution mode upper 8 bit (when RSLTN = 0)							
Illuminance measurement time counter 3H in L-Resolution mode upper 8 bit (when RSLTN = 1)							

TYPICAL CHARACTERISTICS ($T_A = 25^\circ\text{C}$, $V_{DD} = 3.0\text{ V}$, $V_{IO} = 1.8\text{ V}$, unless otherwise specified)

SPECTRAL SENSITIVITY CHARACTERISTICS

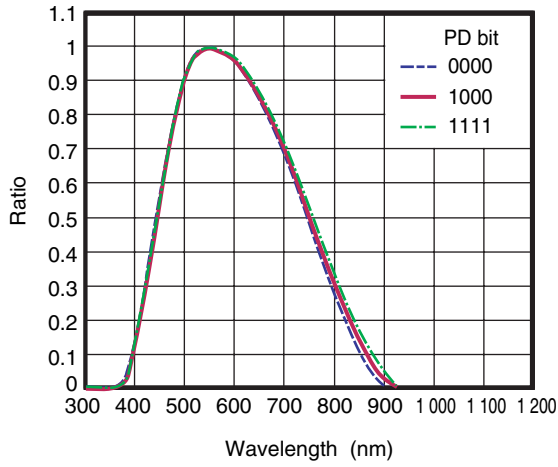

LIGHT SOURCE SENSITIVITY VARIATION

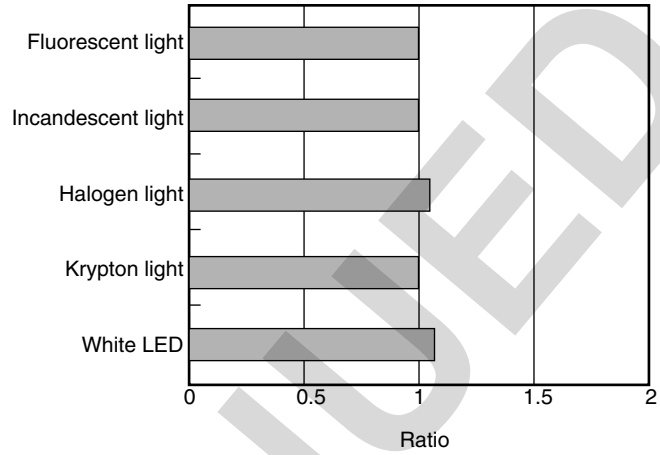

DIRECTIONAL CHARACTERISTICS 1

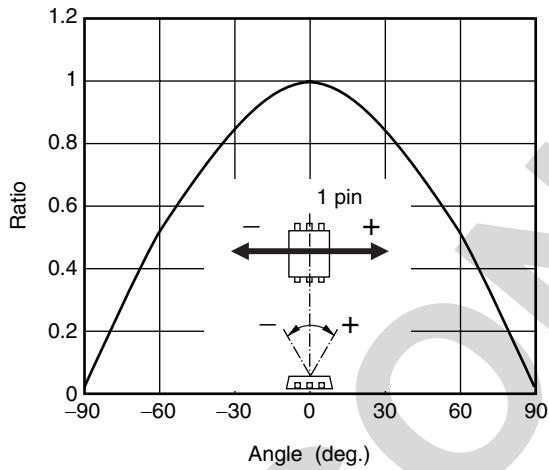

DIRECTIONAL CHARACTERISTICS 2

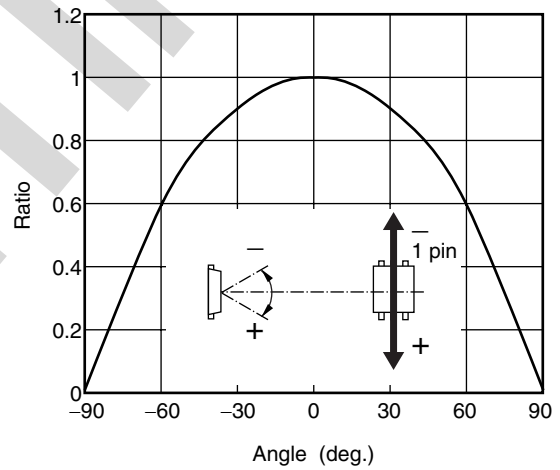

Remark The graphs indicate nominal characteristics.

ILLUMINANCE vs. ILLUMINANCE COUNT

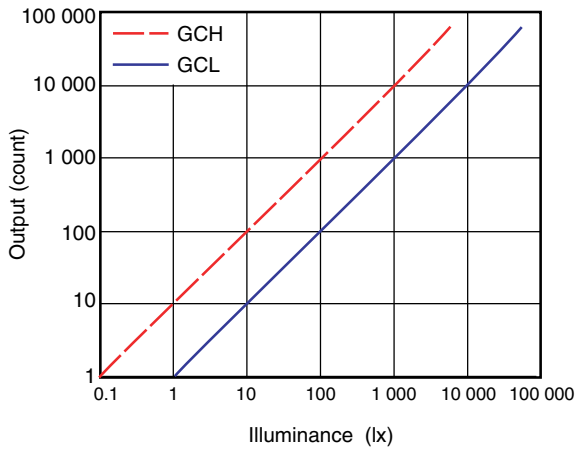

TEMPERATURE DEPENDENCY OF ILLUMINANCE COUNT AT 0 lx

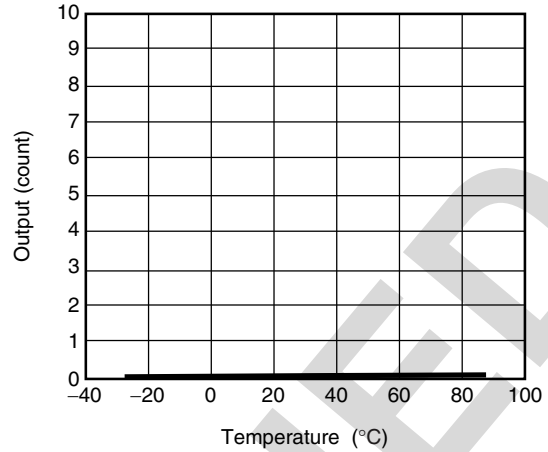

TEMPERATURE DEPENDENCY OF ILLUMINANCE COUNT AT 100 lx (NORMALIZED AT 25°C)

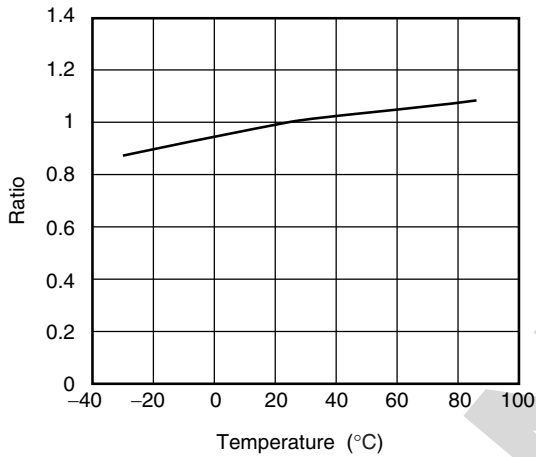

V_{DD} DEPENDENCY OF ILLUMINANCE COUNT AT 100 lx (NORMALIZED AT V_{DD} = 3 V)

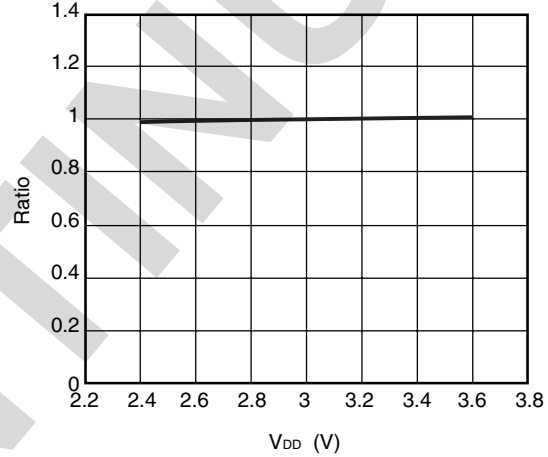

PD BIT SET DEPENDENCY OF ILLUMINANCE COUNT (NORMALIZED AT PD BIT = 1000, FLUORESCENT LIGHT)

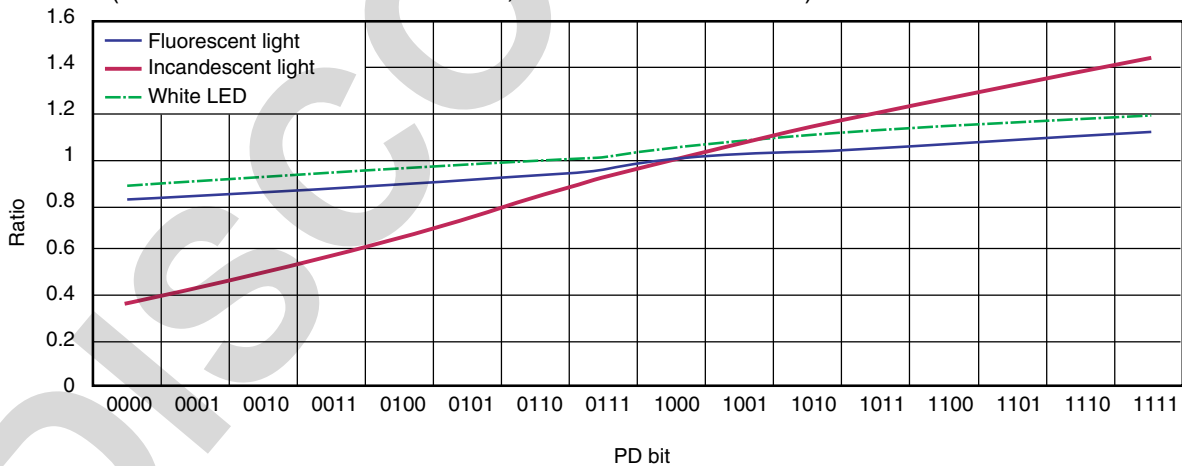

Remark The graphs indicate nominal characteristics.

TAPING SPECIFICATIONS (UNIT: mm)

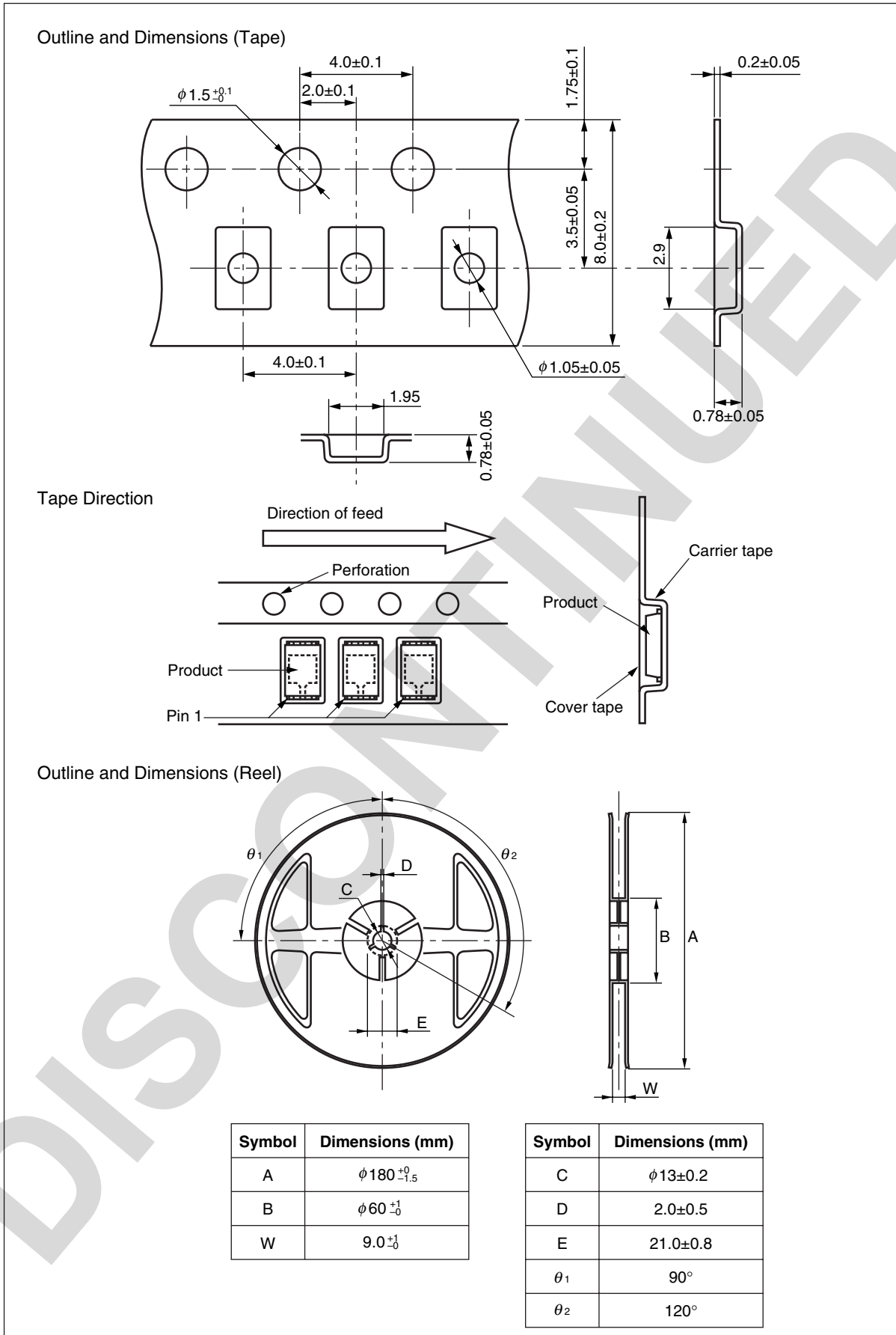

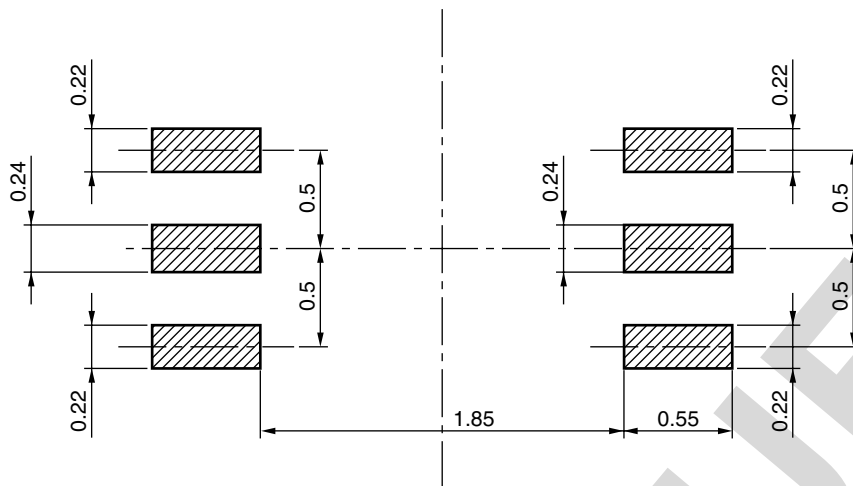
RECOMMENDED MOUNT PAD DIMENSIONS (Unit: mm)

Remark All dimensions in this figure must be evaluated before use.

NOTES ON HANDLING

1. Recommended reflow soldering conditions (including infrared reflow, convection reflow, and infrared + convection reflow)

- (1) This product is dry-packed with desiccant in order to avoid moisture absorption.
- (2) After breaking the seal, reflow soldering must be done within 168 hours under the recommended temperature profile shown below.
- (3) If more than 168 hours have passed after breaking the seal, the baking process must be done by using a tape and reel.
Baking conditions: Once, with tape and reel, $60\pm 5^{\circ}\text{C}$, 10 to 24 hours
After the baking process, this product must be stored under conditions of 30°C or below, 70% RH or below, and reflow soldering must be done within 168 hours.

<Storage conditions after breaking seal>

- Storage conditions : 30°C or below, 70% RH or below
- Maximum storage period after breaking seal : 168 hours (Second reflow soldering must be completed within 168 hours.)

<Reflow soldering conditions>

- Peak reflow temperature : 260°C or below (Package surface temperature)
- Maximum number of reflows : 2
- No repair by hand soldering
- Maximum chlorine content of rosin flux (percentage mass) : 0.2% or less

Recommended Temperature Profile of Reflow

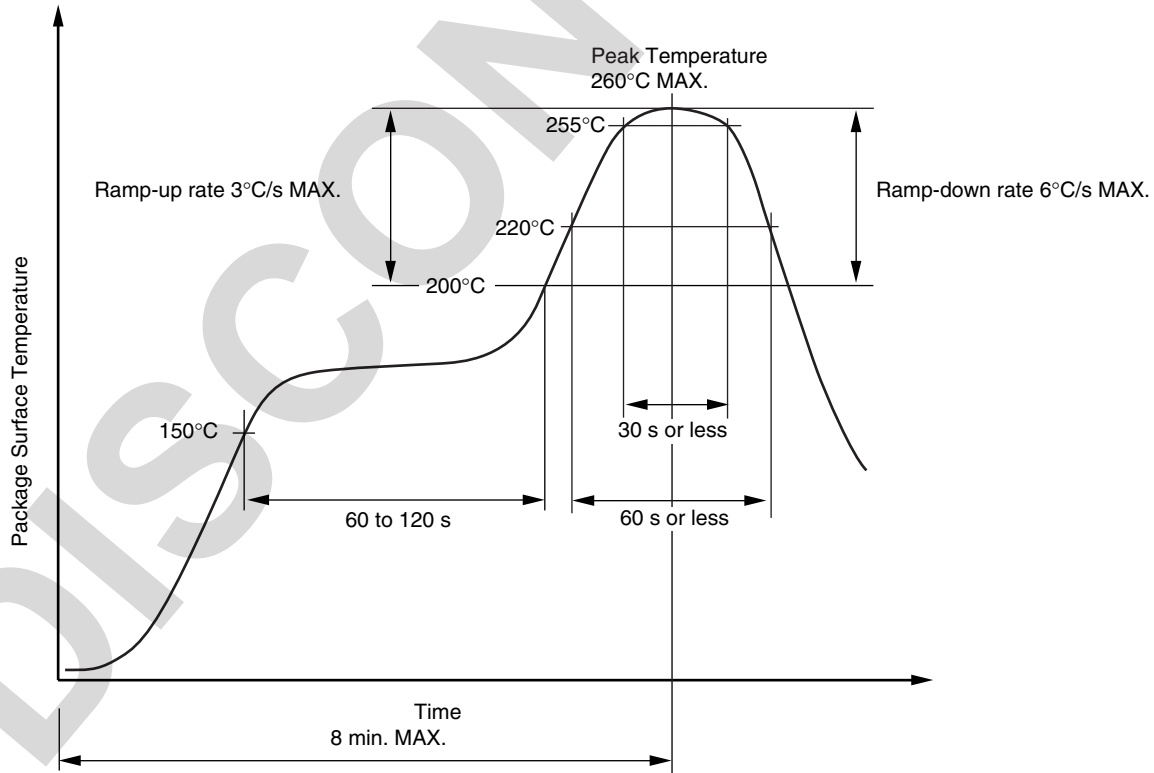

Revision History	PH5553A2NA1 Data Sheet
-------------------------	-------------------------------

Rev.	Date	Description	
		Page	Summary
1.00	Nov 07, 2012	-	First edition issued

DISCONTINUED

All trademarks and registered trademarks are the property of their respective owners.