

Small-sized Class-D Speaker Amplifiers



Analog Input Monaural Class-D Speaker Amplifiers

BD5632NUX, BD5634NUX, BD5638NUX

No.10101EAT04

●Description

BD5632NUX, BD5634NUX and BD5638NUX are a low voltage drive class-D speaker amplifier that was developed for mobile phones, mobile audio products and the others. BD5632NUX has a fixed gain of 6dB, BD5634NUX has a fixed gain of 12dB, and BD5638NUX has a fixed gain of 18dB. It is suitable for the application of battery drive because of high efficiency and low power consumption. Also, stand-by current is 0μA (typ.), and fast transitions from standby to active with little pop noise. It is suitable for applications that switch repeatedly between stand-by and active.

●Features

- 1) LC Filter less
- 2) Only 3 external components
- 3) High power 2.5W/4ohm/BTL (VDD=5V, RL=4ohm, THD+N=10%, typ.)
- 4) High power 0.85W/8ohm/BTL (VDD=3.6V, RL=8ohm, THD+N=10%, typ.)
- 5) Analog differential input / PWM digital output
- 6) Pop noise suppression circuit
- 7) Standby function (Mute function)
- 8) Protection circuit
(Short protection [Auto recover without power cycling], Thermal shutdown, under voltage lockout)
- 9) Ultra small package VSON008X2030 (2.0×3.0×0.6mmMAX)

●Applications

Mobile phones, PND (Personal Navigation Device), DSC, PDA, etc

●Line up matrix

Production Name	BD5632NUX	BD5634NUX	BD5638NUX
Gain (dB)	6	12	18
Input Impedance (kΩ)	100	50	25
Package	VSON008X2030		

●Absolute maximum ratings (Ta=25°C)

Parameter	Symbol	Ratings	Unit
Power Supply Voltage	VDD	7.0	V
Power Dissipation	Pd	0.52 *1	W
Storage Temperature Range	Tstg	-55 ~ +150	°C
STBY Terminal Input Range	Vstby	-0.3 ~ VDD+0.3	V
IN+, IN- Terminal Input Range	Vin	-0.3 ~ VDD+0.3	V

(*1) ROHM standard board mounted (Board size 70mm×70mm×1.6mmt, 1layer), de-rate the value 4.16mW/deg above Ta=+25deg.

●Operating conditions

Parameter	Symbol	Ratings	Unit
Power Supply Voltage	VDD	+2.5 ~ +5.5	V
Temperature Range	Topr	-40 ~ +85	°C

*This product is not designed for protection against radioactive rays.

●Electric characteristics

(Unless otherwise specified, Ta=+25deg, VDD=+3.6V, f=1 kHz, RL=8Ω, AC item=LC Filter; L=22μH, C=1μF)

Parameter	Symbol	Limits			Unit	Conditions
		MIN.	TYP.	MAX.		
Circuit current (No signal)	I _{CC}	—	2.7	5.4	mA	Active mode, No load
Circuit current (Standby)	I _{STBY}	—	0.1	2	μA	Standby mode
Output power1	P _{O1}	450	680	—	mW	BTL, f=1kHz, THD+N=1% *1
Output power2	P _{O2}	550	850	—	mW	BTL, f=1kHz, THD+N=10% *1
Voltage gain (BD5632NUX)	G _V	5.5	6.0	6.5	dB	BTL
Voltage gain (BD5634NUX)		11.5	12.0	12.5		
Voltage gain (BD5638NUX)		17.0	18.0	19.0		
Switching Frequency	f _{osc}	150	250	350	kHz	
Start-up time	T _{on}	0.36	0.51	0.85	msec	
STBY threshold voltage	V _{STBY}	0.4	—	1.4	V	Active to standby shift
Input impedance (STBY)	R _{STBY}	210	300	390	kohm	
Input impedance (IN+/-) (BD5632NUX)	R _{IN}	70	100	130	kohm	
Input impedance (IN+/-) (BD5634NUX)		35	50	65		
Input impedance (IN+/-) (BD5638NUX)		17.5	25	32.5		

*1:B.W. =20 kHz-LPF, BTL: The voltage between 5 pin and 8 pin

●Measurement Circuit Diagram

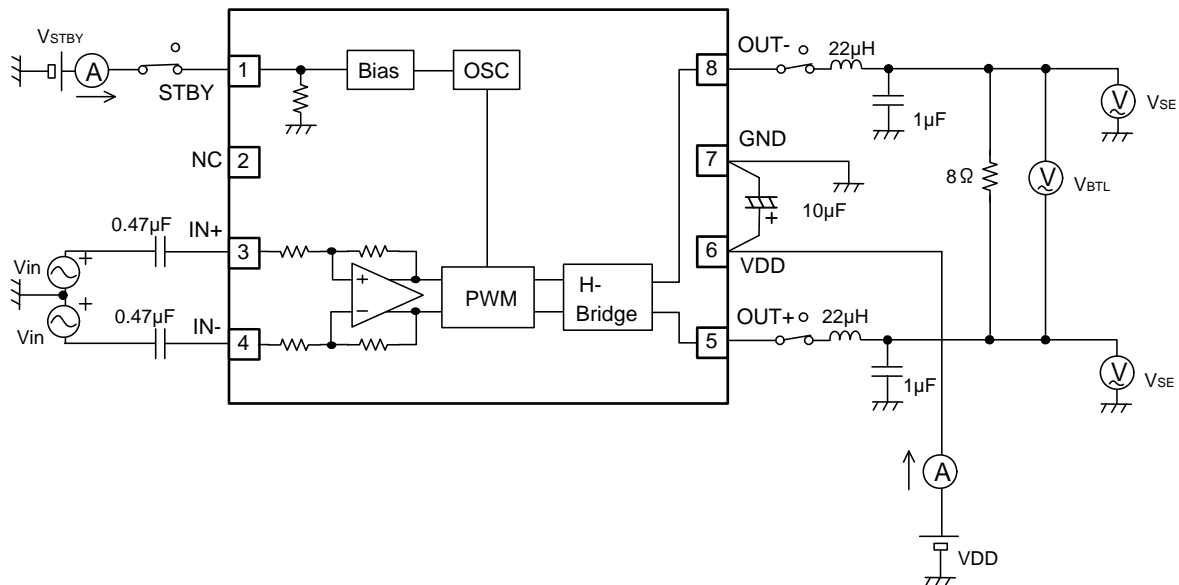

●Active/Standby Control

STBY Pin (1pin)

Mode	Pin Level	Conditions
Active	H	IC Active
Standby	L	IC Shutdown

● Package Outline

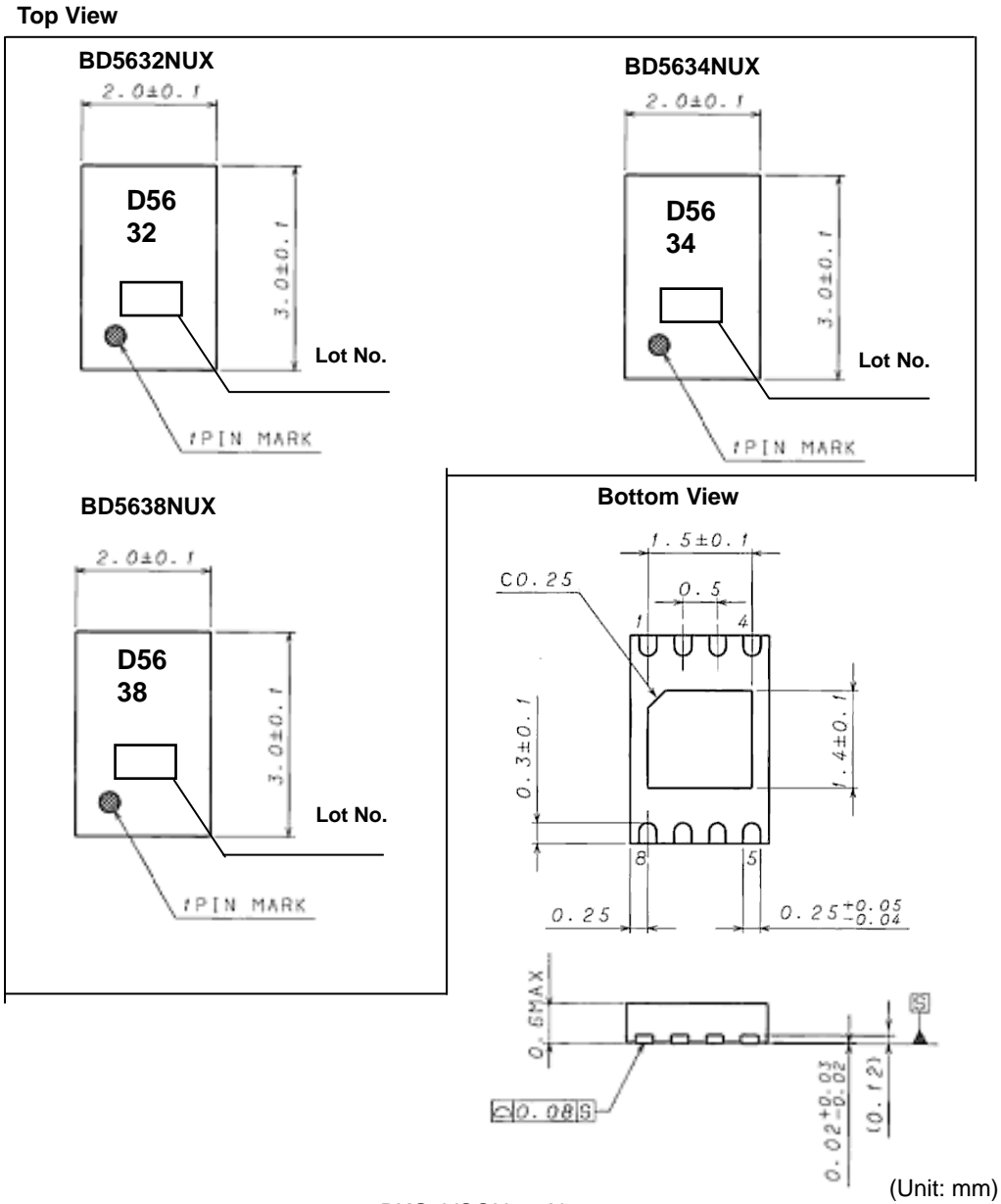

PKG: VSON008X2030

● Block Diagram

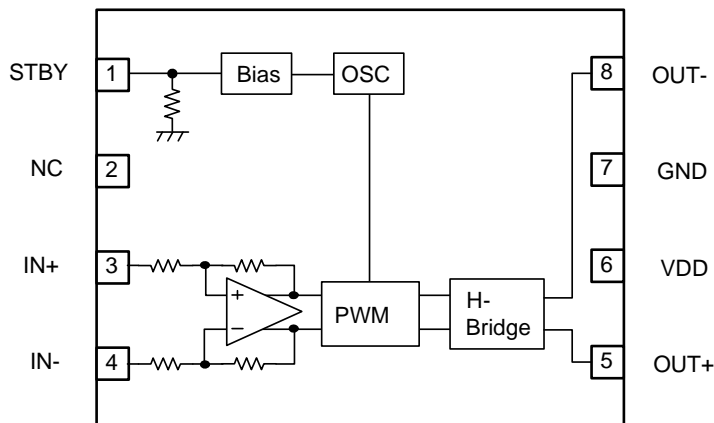

● Pin Assignment Chart

PIN No.	PIN Name
1	STBY
2	NC
3	IN+
4	IN-
5	OUT+
6	VDD
7	GND
8	OUT-

※NC : Non Connection

● Application Circuit Example



Fig.1 Differential Input for mobile phone



Fig.2 Differential input with coupling input capacitors

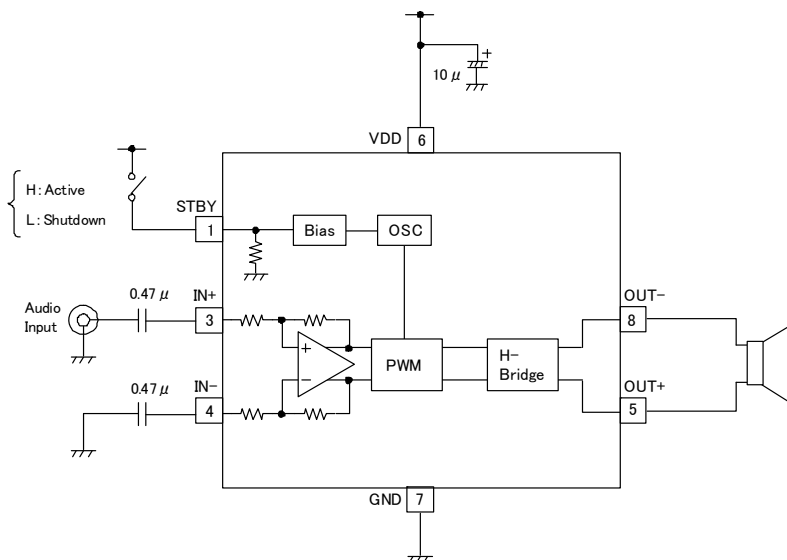
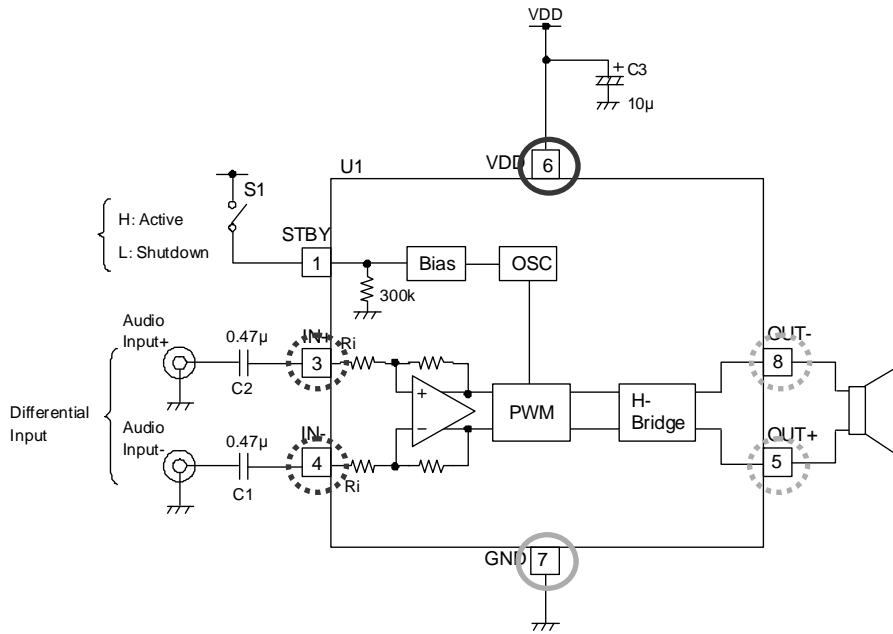
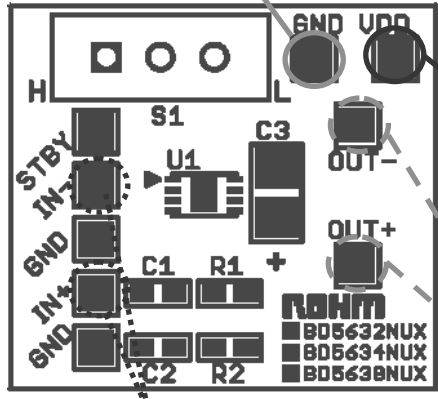

Fig.3 Single-Ended input

●Evaluation board Circuit Diagram



Please connect to GND line.



Please connect to Power Supply (VDD=+2.5~5.5V) line.

Please connect to Input Signal line.

Please connect to Speaker.

●Evaluation board Parts List

Qty.	Item	Description	SMD Size	Manufacturer / Part Number
2	C1, C2	Capacitor, 0.47μF	0603	Murata GRM188R71A474KA01D
1	C3	Capacitor, 10μF	A (3216)	ROHM TCFGA1A106M8R
1	S1	Slide Switch	4mm X 10.2mm	NKK SS-12SDP2
1	U1	IC Mono Class-D audio amplifier	2.0mm X 3.0mm VSON Package	ROHM BD5632/34/38NUX
1	PCB1	Printed-circuit board, BD5632/34/38NUX EVM	—	—

●Description of External components

1. Input coupling capacitor (C1, C2)

It makes an Input coupling capacitor 0.47μF.

It sets cutoff frequency f_c by the following formula by input coupling capacitor C1 (=C2) and input impedance R_i .

$$f_c = \frac{1}{2\pi \times R_i \times C_1} [\text{Hz}]$$

In case of C1 (=C2) =0.47μF

BD5632NUX $R_i = 100\text{k}\Omega$: $f_c = 3.5\text{Hz}$

BD5634NUX $R_i = 50\text{k}\Omega$: $f_c = 7\text{Hz}$

BD5638NUX $R_i = 25\text{k}\Omega$: $f_c = 14\text{Hz}$

2. Power decoupling capacitor (C3)

It makes a power decoupling capacitor 10μF.

When making capacitance of the power decoupling capacitor, there is an influence in the Audio characteristic.

When making small, careful for the Audio characteristic at the actual application.

●Evaluation board PCB layer

TOP Layer silk pattern

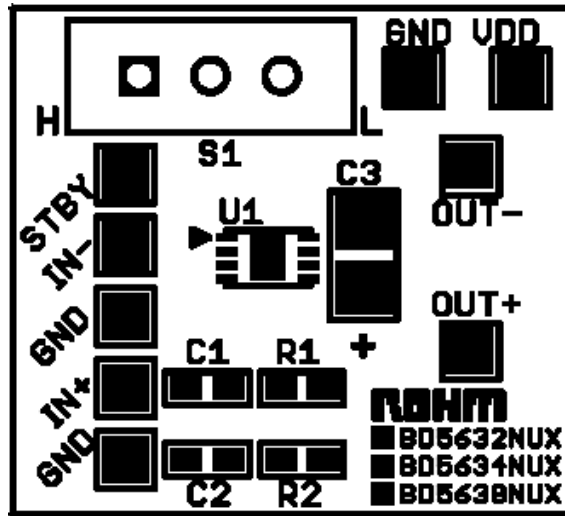

TOP Layer

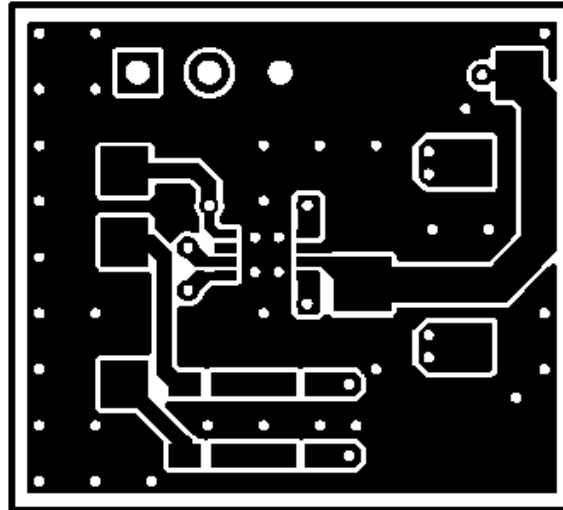

Bottom Layer

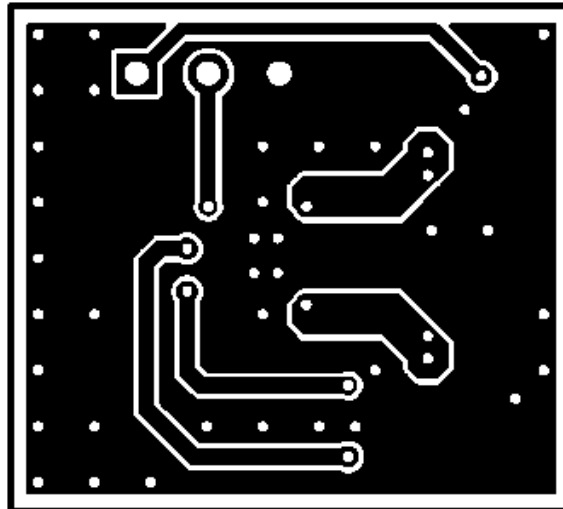

●The way of evaluating Audio characteristic

Evaluation Circuit Diagram

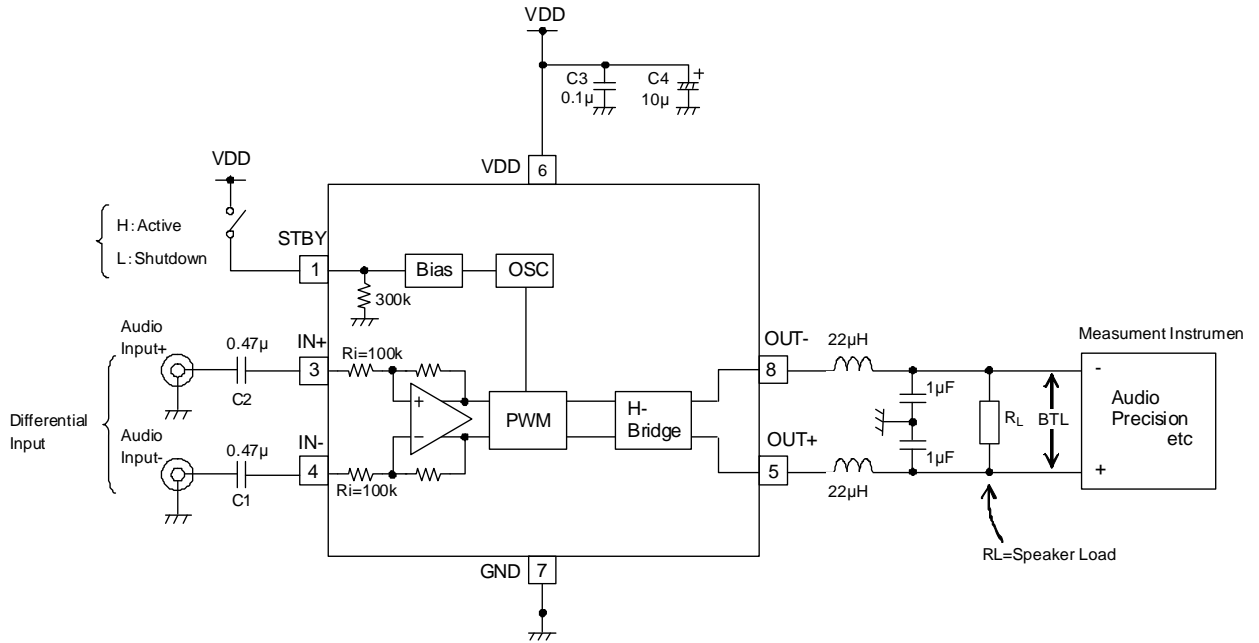

When measuring Audio characteristics, insert LC filter during the output terminal of IC and the speaker load and measure it. Arrange LC filter as close as possible to the output terminal of IC. In case of L=22µH, C=1µF, the cut-off frequency becomes the following.

Use a big current type - Inductor L.
(Reference)
TDK : SLF12575T-220M4R0

$$f_c = \frac{1}{2\pi\sqrt{LC}} = \frac{1}{2\pi\sqrt{22\mu\text{H} \times 1\mu\text{F}}} \cong 34\text{ kHz}$$

●About the thermal design by the IC

Characteristics of an IC have a great deal to do with the temperature at which it is used, and exceeding absolute maximum ratings may degrade and destroy elements. Careful consideration must be given to the heat of the IC from the two standpoints of immediate damage and long-term reliability of operation. Pay attention to points such as the following. Since a maximum junction temperature (T_{jMAX}) or operating temperature range (T_{opr}) is shown in the absolute maximum ratings of the IC, to reference the value, find it using the Pd-Ta characteristic (temperature derating curve). If an input signal is too great when there is insufficient radiation, TSD (thermal shutdown) may operate. TSD, which operates at a chip temperature of approximately +180deg, is canceled when this goes below approximately +100deg. Since TSD operates persistently with the purpose of preventing chip damage, be aware that long-term use in the vicinity that TSD affects decrease IC reliability.

Temperature Derating Curve

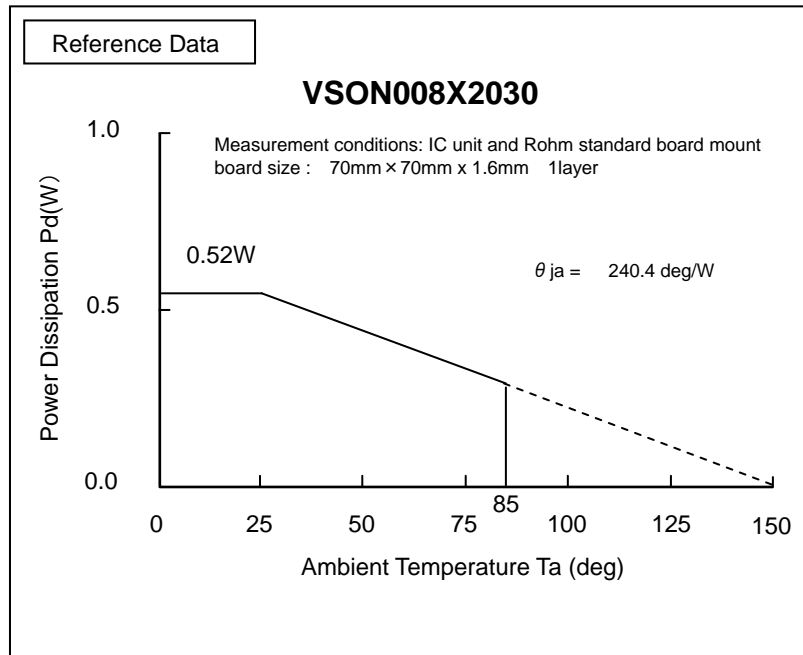

Note) Values are actual measurements and are not guaranteed.

Power dissipation values vary according to the board on which the IC is mounted. The Power dissipation of this IC when mounted on a multilayer board designed to radiate is greater than the values in the graph above.

●Reference Data

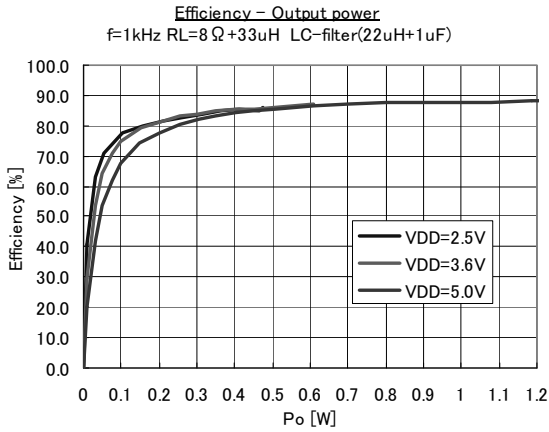

Fig.4

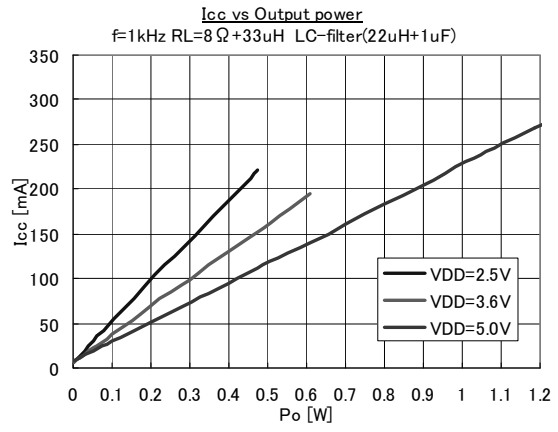

Fig.5

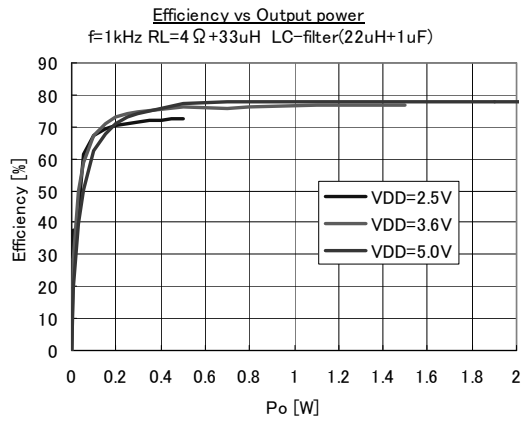

Fig.6

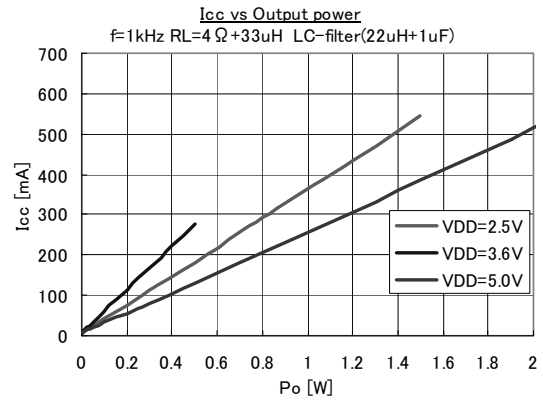

Fig.7

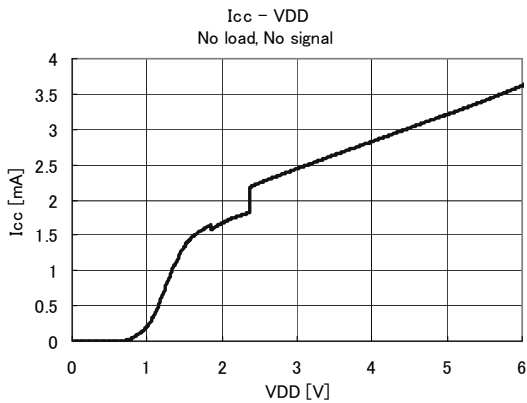

Fig.8

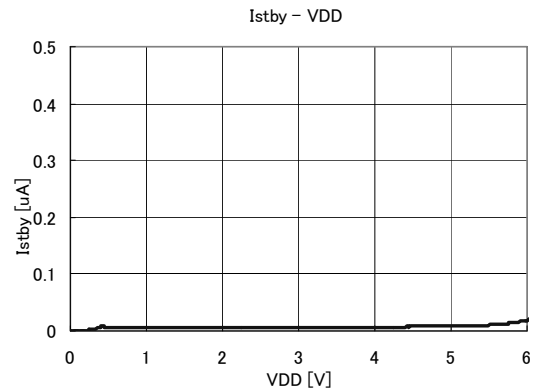

Fig.9

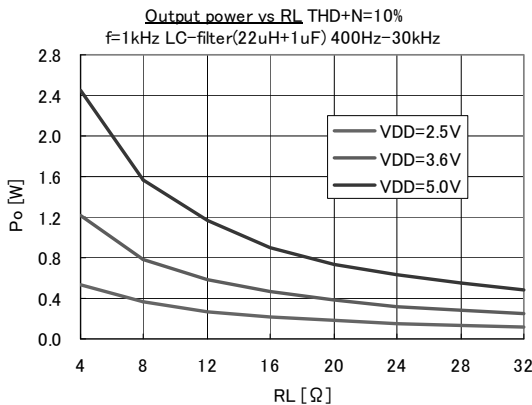

Fig.10

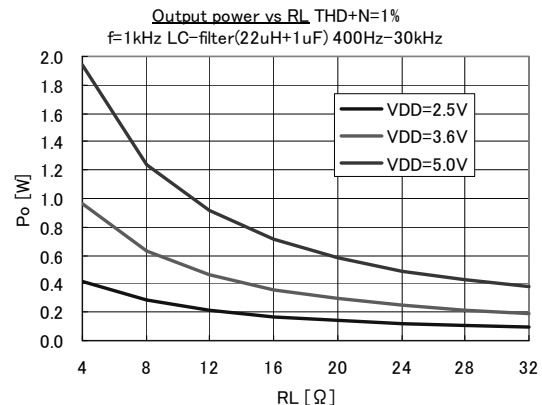

Fig.11

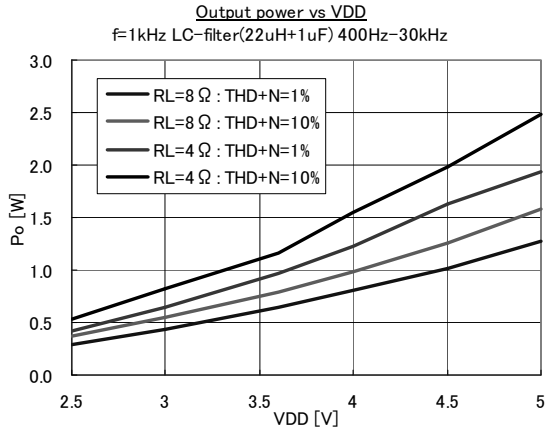

Fig.12

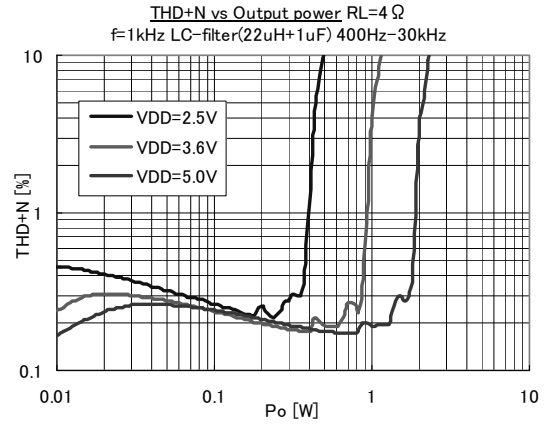

Fig.13

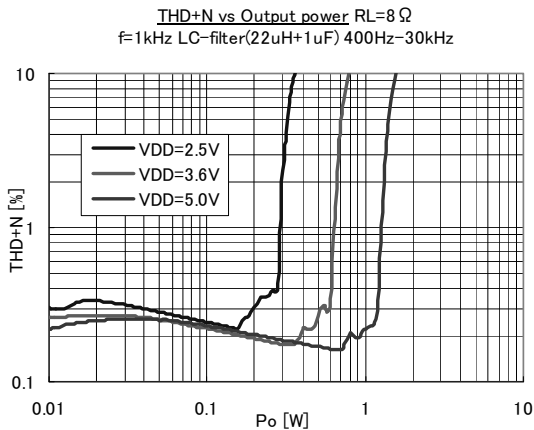

Fig.14

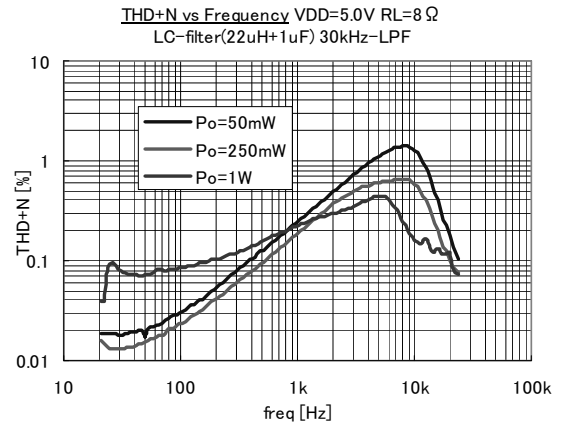

Fig.15

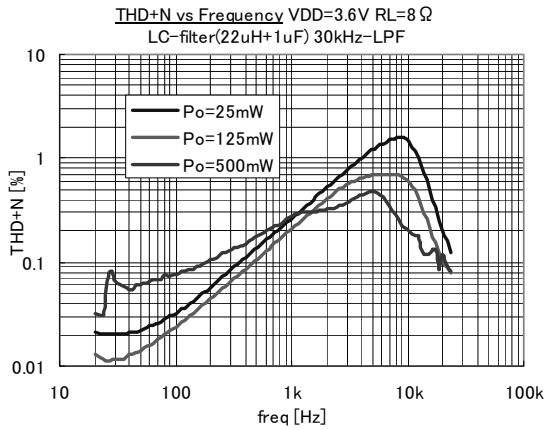

Fig.16

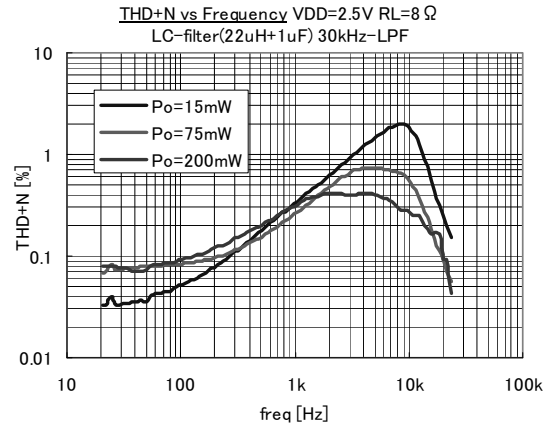

Fig.17

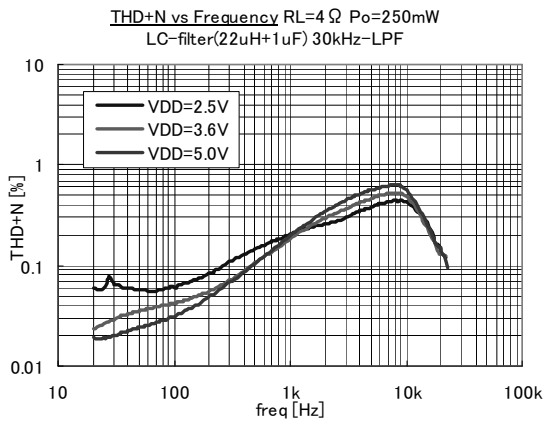

Fig.18

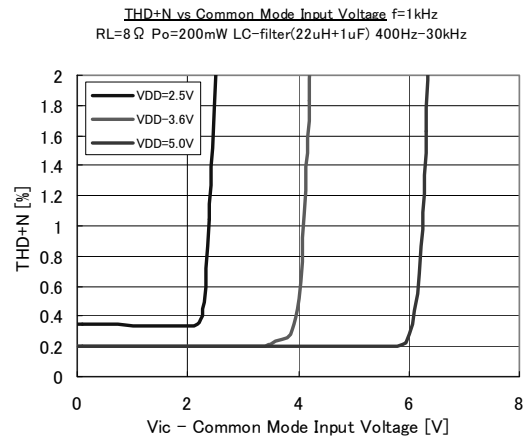
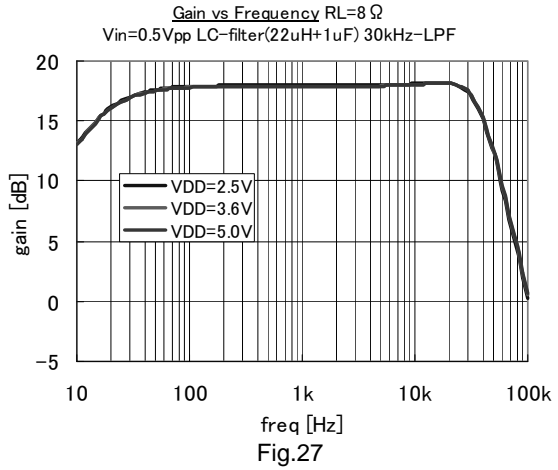
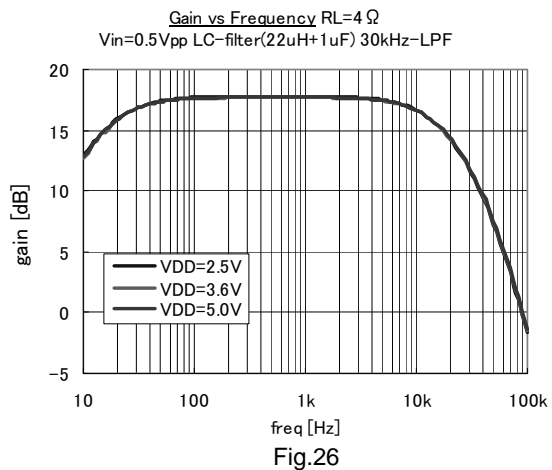
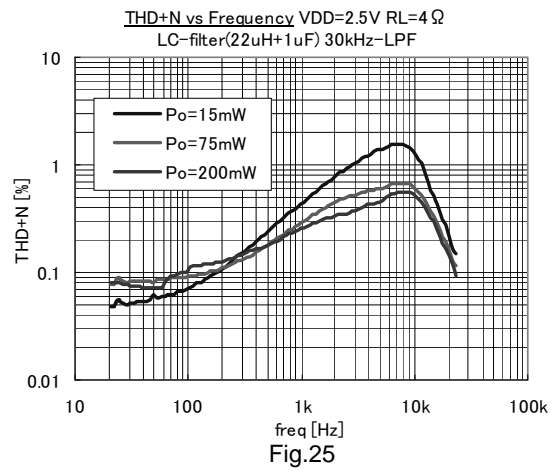
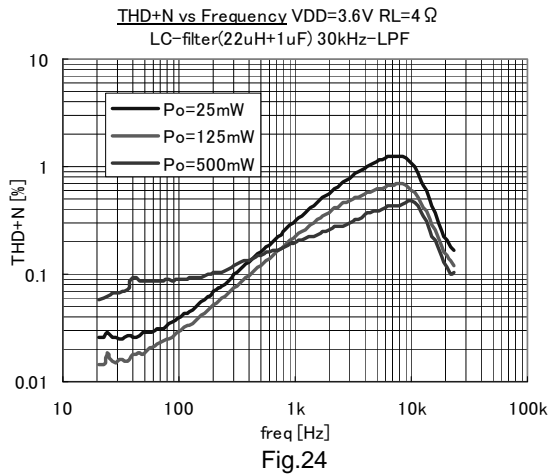
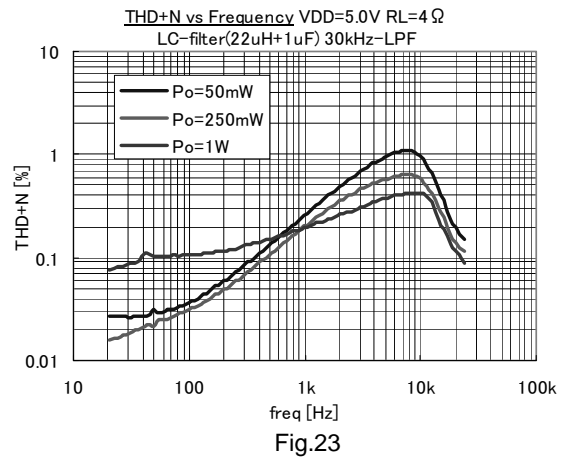
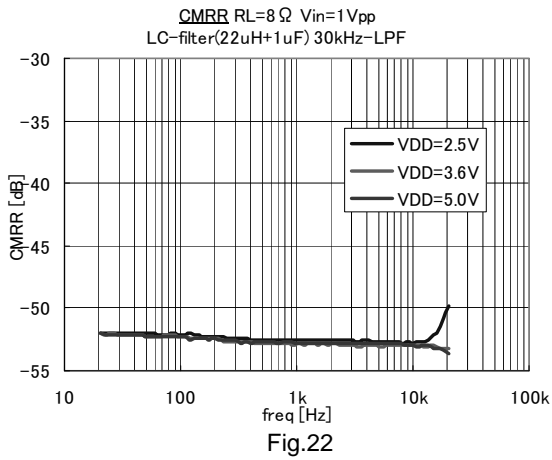
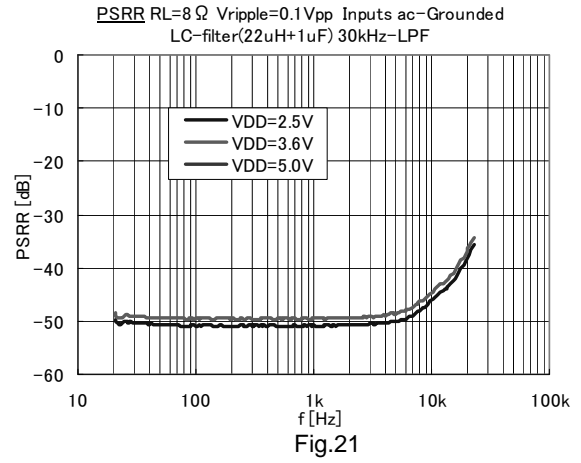
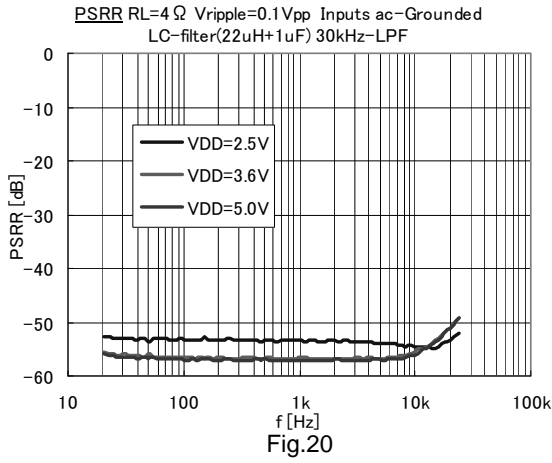

Fig.19



●Notes for use

- (1) Numbers and data in entries are representative design values and are not guaranteed values of the items.
- (2) Although we are confident recommending the sample application circuit, carefully check their characteristics further when using them. When modifying externally attached component constants before use, determine them so that they have sufficient margins by taking into account variations in externally attached components and the Rohm IC, not only for static characteristics but also including transient characteristics.
- (3) Absolute maximum ratings
This IC may be damaged if the absolute maximum ratings for the applied voltage, temperature range, or other parameters are exceeded. Therefore, avoid using a voltage or temperature that exceeds the absolute maximum ratings. If it is possible that absolute maximum ratings will be exceeded, use fuses or other physical safety measures and determine ways to avoid exceeding the IC's absolute maximum ratings.
- (4) GND terminal's potential
Try to set the minimum voltage for GND terminal's potential, regardless of the operation mode.
- (5) Shorting between pins and mounting errors
When mounting the IC chip on a board, be very careful to set the chip's orientation and position precisely. When the power is turned on, the IC may be damaged if it is not mounted correctly. The IC may also be damaged if a short occurs (due to a foreign object, etc.) between two pins, between a pin and the power supply, or between a pin and the GND.
- (6) Operation in strong magnetic fields
Note with caution that operation faults may occur when this IC operates in a strong magnetic field.
- (7) Thermal design
Ensure sufficient margins to the thermal design by taking in to account the allowable power dissipation during actual use modes, because this IC is power amp. When excessive signal inputs which the heat dissipation is insufficient condition, it is possible that thermal shutdown circuit is active.
- (8) Thermal shutdown circuit
This product is provided with a built-in thermal shutdown circuit. When the thermal shutdown circuit operates, the output transistors are placed under open status. The thermal shutdown circuit is primarily intended to shut down the IC avoiding thermal runaway under abnormal conditions with a chip temperature exceeding $T_{jmax} = +150\text{deg}$, and is not intended to protect and secure an electrical appliance.
- (9) Load of the output terminal
This IC corresponds to dynamic speaker load, and doesn't correspond to the load except for dynamic speakers.
- (10) The short protection of the output terminal
The short-circuiting protection of this IC corresponds only to "VDD-short" (the short-circuiting with the power) of the output terminal and "GND-short" (the short-circuiting with GND) of the output terminal. It doesn't correspond to the short-circuiting among the output terminals. Also, when the short-circuiting condition of the output terminal is canceled, it detects the high impedance of the output terminal and it is equipped with the auto recover without power cycling(the cancellation) function in the short-circuiting protection. Be careful of the output terminal, because, there is a fear not to return automatically when the short-circuiting condition occurs in pull-up or the pull-down at equal to or less than about $1\text{M}\Omega$ impedance.
- (11) Operating ranges
The rated operating power supply voltage range ($V_{DD}=+2.5\text{V} \sim +5.5\text{V}$) and the rated operating temperature range ($T_a=-40\text{deg} \sim +85\text{deg}$) are the range by which basic circuit functions is operated. Characteristics and rated output power are not guaranteed in all power supply voltage ranges or temperature ranges.
- (12) Electrical characteristics
Electrical characteristics show the typical performance of device and depend on board layout, parts, power supply. The standard value is in mounting device and parts on surface of ROHM's board directly.
- (13) Power decoupling capacitor
Because the big peak current flows through the power line, the class-D amplifier has an influence on the Audio characteristic by the capacitance value or the arrangement part of the power decoupling capacitor. Arrange a power decoupling capacitor as close as possible to the VDD terminal of IC.
- (14) NC terminal (Pin2)
NC terminal (Non Connection Pin) does not connect to the inside circuit. Therefore, please open or connect to GND.

● Ordering part number

B	D
---	---

Part No.

5	6	3	2
---	---	---	---

Part No.
5632
5634
5638

N	U	X
---	---	---

Package
NUX:VSON008X2030

T	R
---	---

Packaging and forming specification
TR: Embossed tape and reel

VSON008X2030



<Tape and Reel information>

Tape	Embossed carrier tape
Quantity	4000pcs
Direction of feed	TR (The direction is the 1pin of product is at the upper right when you hold reel on the left hand and you pull out the tape on the right hand)

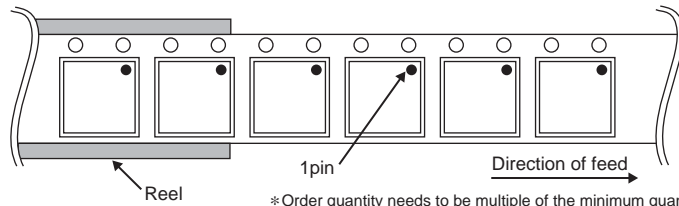

* Order quantity needs to be multiple of the minimum quantity.

Notes

No copying or reproduction of this document, in part or in whole, is permitted without the consent of ROHM Co.,Ltd.

The content specified herein is subject to change for improvement without notice.

The content specified herein is for the purpose of introducing ROHM's products (hereinafter "Products"). If you wish to use any such Product, please be sure to refer to the specifications, which can be obtained from ROHM upon request.

Examples of application circuits, circuit constants and any other information contained herein illustrate the standard usage and operations of the Products. The peripheral conditions must be taken into account when designing circuits for mass production.

Great care was taken in ensuring the accuracy of the information specified in this document. However, should you incur any damage arising from any inaccuracy or misprint of such information, ROHM shall bear no responsibility for such damage.

The technical information specified herein is intended only to show the typical functions of and examples of application circuits for the Products. ROHM does not grant you, explicitly or implicitly, any license to use or exercise intellectual property or other rights held by ROHM and other parties. ROHM shall bear no responsibility whatsoever for any dispute arising from the use of such technical information.

The Products specified in this document are intended to be used with general-use electronic equipment or devices (such as audio visual equipment, office-automation equipment, communication devices, electronic appliances and amusement devices).

The Products specified in this document are not designed to be radiation tolerant.

While ROHM always makes efforts to enhance the quality and reliability of its Products, a Product may fail or malfunction for a variety of reasons.

Please be sure to implement in your equipment using the Products safety measures to guard against the possibility of physical injury, fire or any other damage caused in the event of the failure of any Product, such as derating, redundancy, fire control and fail-safe designs. ROHM shall bear no responsibility whatsoever for your use of any Product outside of the prescribed scope or not in accordance with the instruction manual.

The Products are not designed or manufactured to be used with any equipment, device or system which requires an extremely high level of reliability the failure or malfunction of which may result in a direct threat to human life or create a risk of human injury (such as a medical instrument, transportation equipment, aerospace machinery, nuclear-reactor controller, fuel-controller or other safety device). ROHM shall bear no responsibility in any way for use of any of the Products for the above special purposes. If a Product is intended to be used for any such special purpose, please contact a ROHM sales representative before purchasing.

If you intend to export or ship overseas any Product or technology specified herein that may be controlled under the Foreign Exchange and the Foreign Trade Law, you will be required to obtain a license or permit under the Law.



Thank you for your accessing to ROHM product informations.
More detail product informations and catalogs are available, please contact us.

ROHM Customer Support System

<http://www.rohm.com/contact/>