

MCR310 Series

Preferred Device

Silicon Controlled Rectifiers

Reverse Blocking Triode Thyristors

Designed for industrial and consumer applications such as temperature, light and speed control; process and remote controls; warning systems; capacitive discharge circuits and MPU interface.

- Center Gate Geometry for Uniform Current Density
- All Diffused and Glass-Passivated Junctions for Parameter Uniformity and Stability
- Small, Rugged, Thermowatt Construction for Low Thermal Resistance, High Heat Dissipation and Durability
- Low Trigger Currents, 200 μ A Maximum for Direct Driving from Integrated Circuits
- Pb-Free Packages are Available

MAXIMUM RATINGS ($T_J = 25^\circ\text{C}$ unless otherwise noted.)

Rating	Symbol	Value	Unit
Peak Repetitive Forward and Reverse Blocking Voltage ⁽¹⁾ ($T_J = -40$ to 110°C) (1/2 Sine Wave, $R_{GK} = 1 \text{ k}\Omega$) MCR310-6 MCR310-8 MCR310-10	V_{DRM} or V_{RRM}	400 600 800	Volts
On-State RMS Current ($T_C = 75^\circ\text{C}$)	$I_{T(RMS)}$	10	Amps
Peak Non-repetitive Surge Current (1/2 Cycle, 60 Hz, $T_J = -40$ to 110°C)	I_{TSM}	100	Amps
Circuit Fusing ($t = 8.3 \text{ ms}$)	I^2t	40	A^2s
Peak Gate Voltage ($t \leq 10 \mu\text{s}$)	V_{GM}	± 5	Volts
Peak Gate Current ($t \leq 10 \mu\text{s}$)	I_{GM}	1	Amp
Peak Gate Power ($t \leq 10 \mu\text{s}$)	P_{GM}	5	Watts
Average Gate Power	$P_{G(AV)}$	0.75	Watt
Operating Junction Temperature Range	T_J	-40 to $+110$	$^\circ\text{C}$
Storage Temperature Range	T_{stg}	-40 to $+150$	$^\circ\text{C}$
Mounting Torque	-	8	in.-lb.

THERMAL CHARACTERISTICS

Characteristic	Symbol	Max	Unit
Thermal Resistance, Junction to Case	$R_{\theta JC}$	2.2	$^\circ\text{C}/\text{W}$
Thermal Resistance, Junction to Ambient	$R_{\theta JA}$	60	$^\circ\text{C}/\text{W}$

Stresses exceeding Maximum Ratings may damage the device. Maximum Ratings are stress ratings only. Functional operation above the Recommended Operating Conditions is not implied. Extended exposure to stresses above the Recommended Operating Conditions may affect device reliability.

(1) V_{DRM} and V_{RRM} for all types can be applied on a continuous basis. Ratings apply for zero or negative gate voltage; however, positive gate voltage shall not be applied concurrent with negative potential on the anode. Blocking voltages shall not be tested with a constant current source such that the voltage ratings of the devices are exceeded.



Expertise Applied | Answers Delivered

Littelfuse.com

SCRs
10 AMPERES RMS
400 thru 800 VOLTS

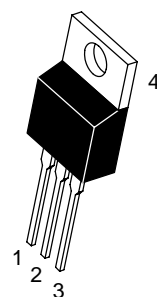

TO-220AB
CASE 221A
STYLE 3

- x = 6, 8 or 10
- A = Assembly Location
- Y = Year
- WW = Work Week
- G = Pb-Free Package

MARKING DIAGRAM

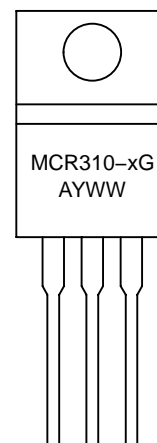

ORDERING INFORMATION

Device	Package	Shipping
MCR310-6	TO220AB	500/Box
MCR310-6G	TO220AB (Pb-Free)	500/Box
MCR310-8	TO220AB	500/Box
MCR310-8G	TO220AB (Pb-Free)	500/Box
MCR310-10	TO220AB	500/Box
MCR310-10G	TO220AB (Pb-Free)	500/Box

Preferred devices are recommended choices for future use and best overall value.

MCR310 Series

ELECTRICAL CHARACTERISTICS ($T_C = 25^\circ\text{C}$, $R_{GK} = 1\text{ k}\Omega$ unless otherwise noted)

Characteristic		Symbol	Min	Typ	Max	Unit
Peak Forward Blocking Current ⁽¹⁾ ($T_J = 110^\circ\text{C}$, $V_D = \text{Rated } V_{DRM}$)	$T_C = 110^\circ\text{C}$	I_{DRM}	—	—	500	μA
	$T_C = 25^\circ\text{C}$		—	—	10	μA
Peak Reverse Blocking Current ⁽¹⁾ ($T_J = 110^\circ\text{C}$, $V_R = \text{Rated } V_{RRM}$)	$T_C = 110^\circ\text{C}$	I_{RRM}	—	—	500	μA
	$T_C = 25^\circ\text{C}$		—	—	10	μA
On-State Voltage ($I_{TM} = 20\text{ A Peak}$, Pulse Width $\leq 1\text{ ms}$, Duty Cycle $\leq 2\%$)		V_{TM}	—	1.7	2.2	Volts
Gate Trigger Current, Continuous dc ⁽²⁾ ($V_D = 12\text{ V}$, $R_L = 100\ \Omega$)		I_{GT}	—	30	200	μA
Gate Trigger Voltage, Continuous dc ($V_D = 12\text{ V}$, $R_L = 100\ \Omega$) ($V_D = \text{Rated } V_{DRM}$, $R_L = 10\text{ k}\Omega$, $T_J = 110^\circ\text{C}$)		V_{GT}	—	0.5	1.5	Volts
			0.1	—	—	
Holding Current ($V_D = 12\text{ V}$, $I_{TM} = 100\text{ mA}$)		I_H	—	—	6	mA
Critical Rate of Rise of Forward Blocking Voltage ($V_D = \text{Rated } V_{DRM}$, $T_J = 110^\circ\text{C}$, Exponential Waveform)		dv/dt	—	10	—	V/ μs
Gate Controlled Turn-On Time ($V_D = \text{Rated } V_{DRM}$, $I_{TM} = 20\text{ A}$, $I_G = 2\text{ mA}$)		t_{gt}	—	1	—	μs

1. Ratings apply for negative gate voltage or $R_{GK} = 1\text{ k}\Omega$. Devices shall not have a positive gate voltage concurrently with a negative voltage on the anode. Devices should not be tested with a constant current source for forward and reverse blocking capability such that the voltage applied exceeds the rated blocking voltage.
2. Does not include R_{GK} current.

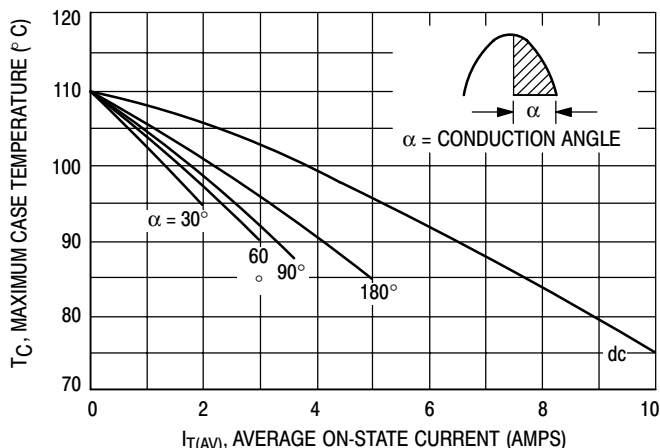

Figure 1. Average Current Derating

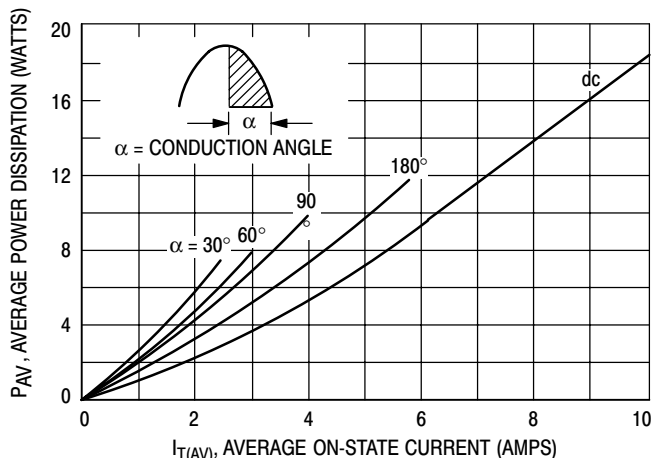

Figure 2. On-State Power Dissipation

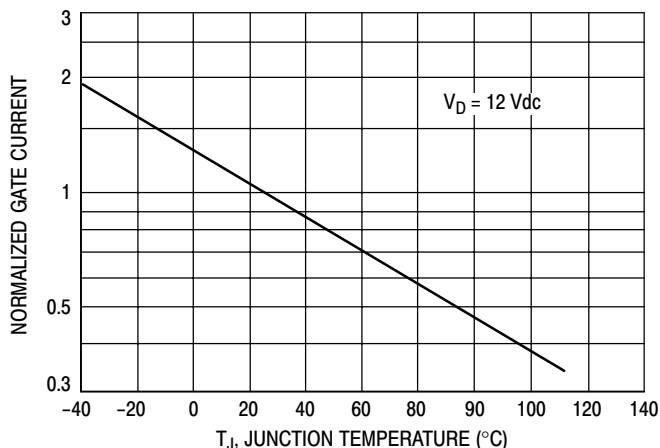

Figure 3. Normalized Gate Current

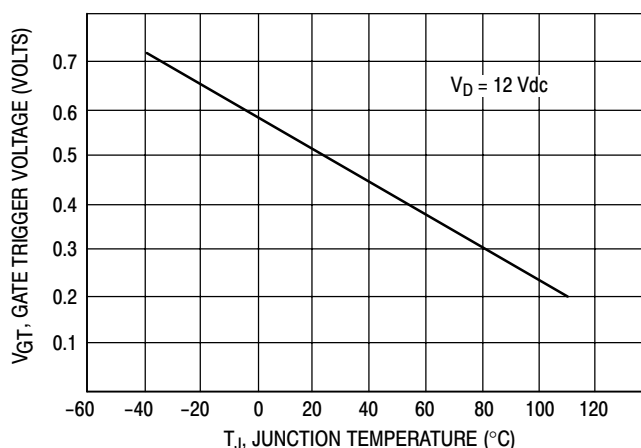
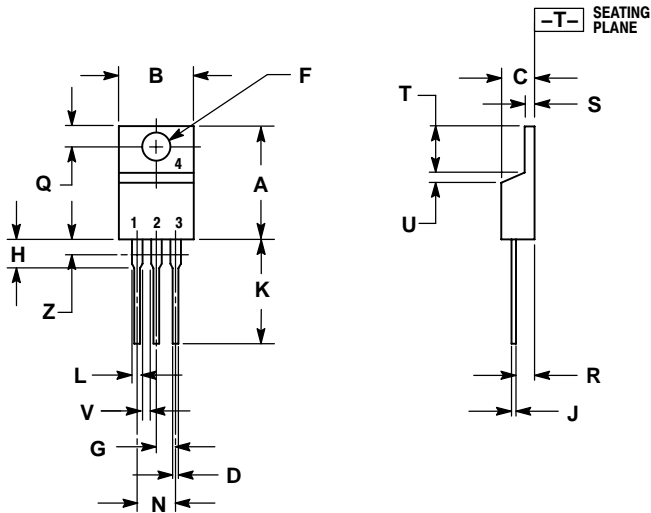

Figure 4. Gate Voltage

MCR310 Series

PACKAGE DIMENSIONS

TO-220AB
CASE 221A-07
ISSUE AA



- NOTES:
1. DIMENSIONING AND TOLERANCING PER ANSI Y14.5M, 1982.
 2. CONTROLLING DIMENSION: INCH.
 3. DIMENSION Z DEFINES A ZONE WHERE ALL BODY AND LEAD IRREGULARITIES ARE ALLOWED.

DIM	INCHES		MILLIMETERS	
	MIN	MAX	MIN	MAX
A	0.570	0.620	14.48	15.75
B	0.380	0.405	9.66	10.28
C	0.160	0.190	4.07	4.82
D	0.025	0.035	0.64	0.88
F	0.142	0.147	3.61	3.73
G	0.095	0.105	2.42	2.66
H	0.110	0.155	2.80	3.93
J	0.014	0.022	0.36	0.55
K	0.500	0.562	12.70	14.27
L	0.045	0.060	1.15	1.52
N	0.190	0.210	4.83	5.33
Q	0.100	0.120	2.54	3.04
R	0.080	0.110	2.04	2.79
S	0.045	0.055	1.15	1.39
T	0.235	0.255	5.97	6.47
U	0.000	0.050	0.00	1.27
V	0.045	---	1.15	---
Z	---	0.080	---	2.04

- STYLE 3:
PIN 1. CATHODE
2. ANODE
3. GATE
4. ANODE

Littelfuse products are not designed for, and shall not be used for, any purpose (including, without limitation, automotive, military, aerospace, medical, life-saving, life-sustaining or nuclear facility applications, devices intended for surgical implant into the body, or any other application in which the failure or lack of desired operation of the product may result in personal injury, death, or property damage) other than those expressly set forth in applicable Littelfuse product documentation. Warranties granted by Littelfuse shall be deemed void for products used for any purpose not expressly set forth in applicable Littelfuse documentation. Littelfuse shall not be liable for any claims or damages arising out of products used in applications not expressly intended by Littelfuse as set forth in applicable Littelfuse documentation. The sale and use of Littelfuse products is subject to Littelfuse Terms and Conditions of Sale, unless otherwise agreed by Littelfuse.

Littelfuse.com