



Is Now Part of



ON Semiconductor®

To learn more about ON Semiconductor, please visit our website at
www.onsemi.com

ON Semiconductor and the ON Semiconductor logo are trademarks of Semiconductor Components Industries, LLC dba ON Semiconductor or its subsidiaries in the United States and/or other countries. ON Semiconductor owns the rights to a number of patents, trademarks, copyrights, trade secrets, and other intellectual property. A listing of ON Semiconductor's product/patent coverage may be accessed at www.onsemi.com/site/pdf/Patent-Marking.pdf. ON Semiconductor reserves the right to make changes without further notice to any products herein. ON Semiconductor makes no warranty, representation or guarantee regarding the suitability of its products for any particular purpose, nor does ON Semiconductor assume any liability arising out of the application or use of any product or circuit, and specifically disclaims any and all liability, including without limitation special, consequential or incidental damages. Buyer is responsible for its products and applications using ON Semiconductor products, including compliance with all laws, regulations and safety requirements or standards, regardless of any support or applications information provided by ON Semiconductor. "Typical" parameters which may be provided in ON Semiconductor data sheets and/or specifications can and do vary in different applications and actual performance may vary over time. All operating parameters, including "Typicals" must be validated for each customer application by customer's technical experts. ON Semiconductor does not convey any license under its patent rights nor the rights of others. ON Semiconductor products are not designed, intended, or authorized for use as a critical component in life support systems or any FDA Class 3 medical devices or medical devices with a same or similar classification in a foreign jurisdiction or any devices intended for implantation in the human body. Should Buyer purchase or use ON Semiconductor products for any such unintended or unauthorized application, Buyer shall indemnify and hold ON Semiconductor and its officers, employees, subsidiaries, affiliates, and distributors harmless against all claims, costs, damages, and expenses, and reasonable attorney fees arising out of, directly or indirectly, any claim of personal injury or death associated with such unintended or unauthorized use, even if such claim alleges that ON Semiconductor was negligent regarding the design or manufacture of the part. ON Semiconductor is an Equal Opportunity/Affirmative Action Employer. This literature is subject to all applicable copyright laws and is not for resale in any manner.

NC7WZU04

TinyLogic® UHS Dual Unbuffered Inverter

Features

- Space saving SC70 6-lead package
- Ultra small MicroPak™ leadless package
- Unbuffered for crystal oscillator and analog applications
- Balanced output drive: $\pm 8\text{mA}$ at $4.5\text{V } V_{CC}$
- Broad V_{CC} operating range: 1.65V to 5.5V
- Low quiescent power: $I_{CC} < 1\mu\text{A}$ at $5\text{V } V_{CC}$, $T_A = 25^\circ\text{C}$

General Description

The NC7WZU04 is a dual unbuffered inverter from Fairchild's Ultra High Speed Series of TinyLogic® in the space saving SC70 6-lead package. The special purpose unbuffered circuit design is intended for crystal oscillator or analog applications. The internal circuit consists of only one-stage, the output, to allow for this part to be used in these oscillator or analog applications. The device is fabricated with advanced CMOS technology to achieve ultra high speed with high output drive while maintaining low static power dissipation over a very broad V_{CC} operating range. The device is specified to operate over the 1.65V to $5.5\text{V } V_{CC}$ range. The inputs are high impedance when V_{CC} is 0V . Inputs tolerate voltages up to 7V independent of V_{CC} operating voltage.

Ordering Information

Order Number	Package Number	Package Code Top Mark	Package Description	Supplied As
NC7WZU04P6X	MAA06A	ZU4	6-Lead SC70, EIAJ SC88, 1.25mm Wide	3k Units on Tape and Reel
NC7WZU04L6X	MAC06A	B5	6-Lead MicroPak, 1.0mm Wide	5k Units on Tape and Reel

 All packages are lead free per JEDEC: J-STD-020B standard.

Logic Symbol

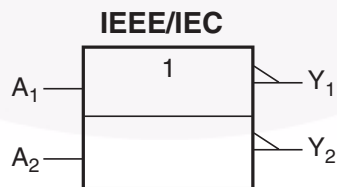

Connection Diagrams

Pin Assignment for SC70

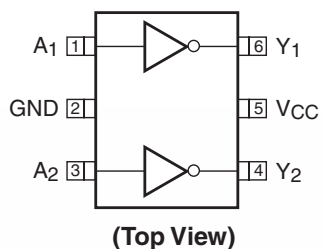

Pin One Orientation Diagram

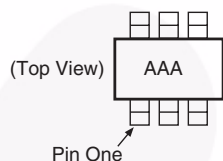

AAA represents Product Code Top Mark – see ordering code

Note: Orientation of Top Mark determines Pin One location. Read the top product code mark left to right, Pin One is the lower left pin (see diagram).

Pad Assignments for MicroPak

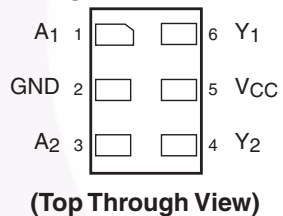

Pin Descriptions

Pin Name	Description
A ₁ , A ₂	Data Inputs
Y ₁ , Y ₂	Outputs

Function Table

$$Y = \bar{A}$$

Input	Output
A	Y
L	H
H	L

H = HIGH Logic Level
L = LOW Logic Level



Absolute Maximum Ratings

The “Absolute Maximum Ratings” are those values beyond which the safety of the device cannot be guaranteed. The device should not be operated at these limits. The parametric values defined in the Electrical Characteristics tables are not guaranteed at the absolute maximum ratings. The “Recommended Operating Conditions” table will define the conditions for actual device operation.

Symbol	Parameter	Rating
V_{CC}	Supply Voltage	-0.5V to +7V
V_{IN}	DC Input Voltage	-0.5V to +7V
V_{OUT}	DC Output Voltage	-0.5V to +7V
I_{IK}	DC Input Diode Current @ $V_{IN} \leq -0.5V$	-50mA
I_{OK}	DC Output Diode Current @ $V_{OUT} < -0.5V$ $V_{OUT} > 0.5V, V_{CC} = GND$	-50mA +50mA
I_{OUT}	DC Output Current	$\pm 50mA$
I_{CC}/I_{GND}	DC V_{CC}/GND Current	$\pm 100mA$
T_{STG}	Storage Temperature	-65°C to +150°C
T_J	Junction Temperature under Bias	150°C
T_L	Junction Lead Temperature (Soldering, 10 seconds)	260°C
P_D	Power Dissipation @ +85°C SC70-6 Micropak-6	215mW 215mW

Recommended Operating Conditions⁽¹⁾

The Recommended Operating Conditions table defines the conditions for actual device operation. Recommended operating conditions are specified to ensure optimal performance to the datasheet specifications. Fairchild does not recommend exceeding them or designing to absolute maximum ratings.

Symbol	Parameter	Rating
V_{CC}	Supply Voltage Operating	1.8V to 5.5V
V_{CC}	Supply Voltage Data Retention	1.5V to 5.5V
V_{IN}	Input Voltage	0V to 5.5V
V_{OUT}	Output Voltage	0V to V_{CC}
T_A	Operating Temperature	-40°C to +85°C
θ_{JA}	Thermal Resistance SC70-6 Micropak-6	350°C/W 350°C/W

Note:

1. Unused inputs must be held HIGH or LOW. They may not float.

DC Electrical Characteristics

Symbol	Parameter	V _{CC} (V)	Conditions		T _A =					Units		
					+25°C			-40°C to +85°C				
					Min .	Typ.	Max .	Min.	Max.			
V _{IH}	HIGH Level Input Voltage	1.8 to 2.7			0.85 V _{CC}			0.85 V _{CC}		V		
		3.0 to 5.5			0.8 V _{CC}			0.8 V _{CC}				
V _{IL}	LOW Level Input Voltage	1.8 to 2.7						0.15 V _{CC}		V		
		3.0 to 5.5						0.2 V _{CC}				
V _{OH}	HIGH Level Output Voltage	1.65	V _{IN} = V _{IL}	I _{OH} = -100μA	1.55	1.65		1.55		V		
		1.8			1.6	1.79		1.6				
		2.3			2.1	2.29		2.1				
		3.0			2.7	2.99		2.7				
		4.5			4.0	4.48		4.0				
			1.65	V _{IN} = GND	I _{OH} = -2mA	1.29	1.52		1.29		V	
			2.3			I _{OH} = -2mA	1.9	2.19		1.9		
			3.0			I _{OH} = -4mA	2.4	2.82		2.4		
			3.0			I _{OH} = -6mA	2.3	2.73		2.3		
			4.5			I _{OH} = -8mA	3.8	4.24		3.8		
VOL	LOW Level Output Voltage	1.65	V _{IN} = V _{IH}	I _{OL} = 100μA		0.01	0.2		0.2	V		
		1.8				0.01	0.2		0.2			
		2.3				0.01	0.2		0.2			
		3.0				0.01	0.3		0.3			
		4.5				0.01	0.5		0.5			
			1.65	V _{IN} = V _{CC}	I _{OL} = 2mA		0.10	0.24		0.24	V	
			2.3			I _{OL} = 2mA		0.12	0.3			0.3
			3.0			I _{OL} = 4mA		0.19	0.4			0.4
			3.0			I _{OL} = 6mA		0.29	0.55			0.55
			4.5			I _{OL} = 8mA		0.29	0.55			0.55
I _{IN}	Input Leakage Current	0 to 5.5	V _{IN} = 5.5V, GND				±0.1		±1.0	μA		
I _{CC}	Quiescent Supply Current	1.65 to 5.5	V _{IN} = 5.5V, GND				1.0		10	μA		
I _{CCPEAK}	Peak Supply Current in Analog Operation	1.8	V _{OUT} = Open V _{IN} = Adjust for Peak I _{CC} Current			0.2				mA		
		2.5				2						
		3.3				5						
		5.0				15						

AC Electrical Characteristics

Symbol	Parameter	V _{CC} (V)	Conditions	T _A =					Units	Figure Number
				+25°C			-40°C to +85°C			
				Min.	Typ.	Max.	Min.	Max.		
t _{PLH} , t _{PHL}	Propagation Delay	1.65	C _L = 15pF, R _L = 1MΩ	1.5	5.5	9.8	1.5	11.0	ns	Figure 1 Figure 3
		1.8		1.5	4.6	8.1	1.5	8.9		
		2.5 ± 0.2		1.2	3.3	5.7	1.2	6.3		
		3.3 ± 0.3		0.8	2.7	4.1	0.8	4.5		
		5.0 ± 0.5		0.5	2.2	3.3	0.5	3.6		
		3.3 ± 0.3		C _L = 50pF, R _L = 500Ω,	1.2	4.0	6.4	1.2		
5.0 ± 0.5	0.8	3.4	5.6		0.8	6.2				
C _{IN}	Input Capacitance	0			3				pF	
C _{PD}	Power Dissipation Capacitance	3.3	Note 2		3.5				pF	Figure 2
		5.0			5.5					

Note:

2. C_{PD} is defined as the value of the internal equivalent capacitance which is derived from dynamic operating current consumption (I_{CCD}) at no output loading and operating at 50% duty cycle. (See Figure 2.) C_{PD} is related to I_{CCD} dynamic operating current by the expression:

$$I_{CCD} = (C_{PD})(V_{CC})(f_{IN}) + (I_{CCstatic}).$$

AC Loading and Waveforms

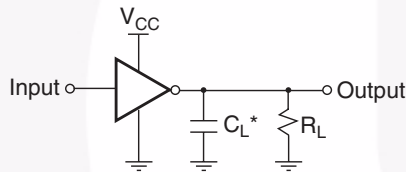

*C_L includes load and stray capacitance.
Input PRR = 1.0MHz; t_w = 500ns

Figure 1. AC Test Circuit

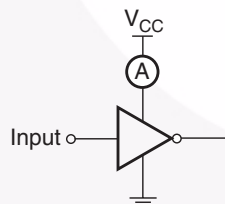

Application Note: When operating the NC7WZU04's unbuffered output stage in its linear range, as in oscillator applications, care must be taken to observe maximum power rating for the device and package. The high drive nature of the design of the output stage will result in substantial simultaneous conduction currents when the stage is in the linear region. See the I_{CCPEAK} specification on page 2.

Input = AC Waveform; t_r, t_f = 1.8ns;
PRR = 10MHz; Duty Cycle = 50%

Figure 2. I_{CCD} Test Circuit

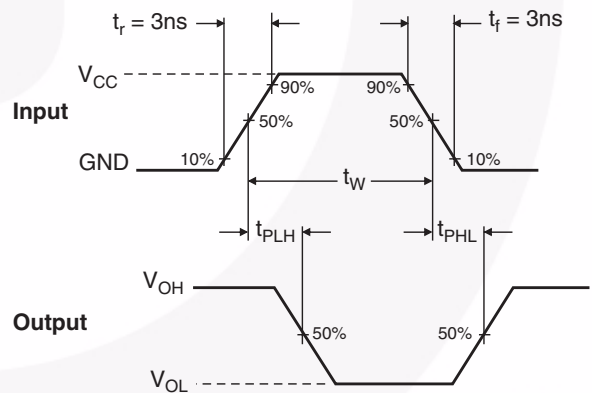

Figure 3. AC Waveforms

Tape and Reel Specification

Tape Format for SC70

Package Designator	Tape Section	Number Cavities	Cavity Status	Cover Tape Status
P6X	Leader (Start End)	125 (typ)	Empty	Sealed
	Carrier	3000	Filled	Sealed
	Trailer (Hub End)	75 (typ)	Empty	Sealed

Tape Dimension inches (millimeters)

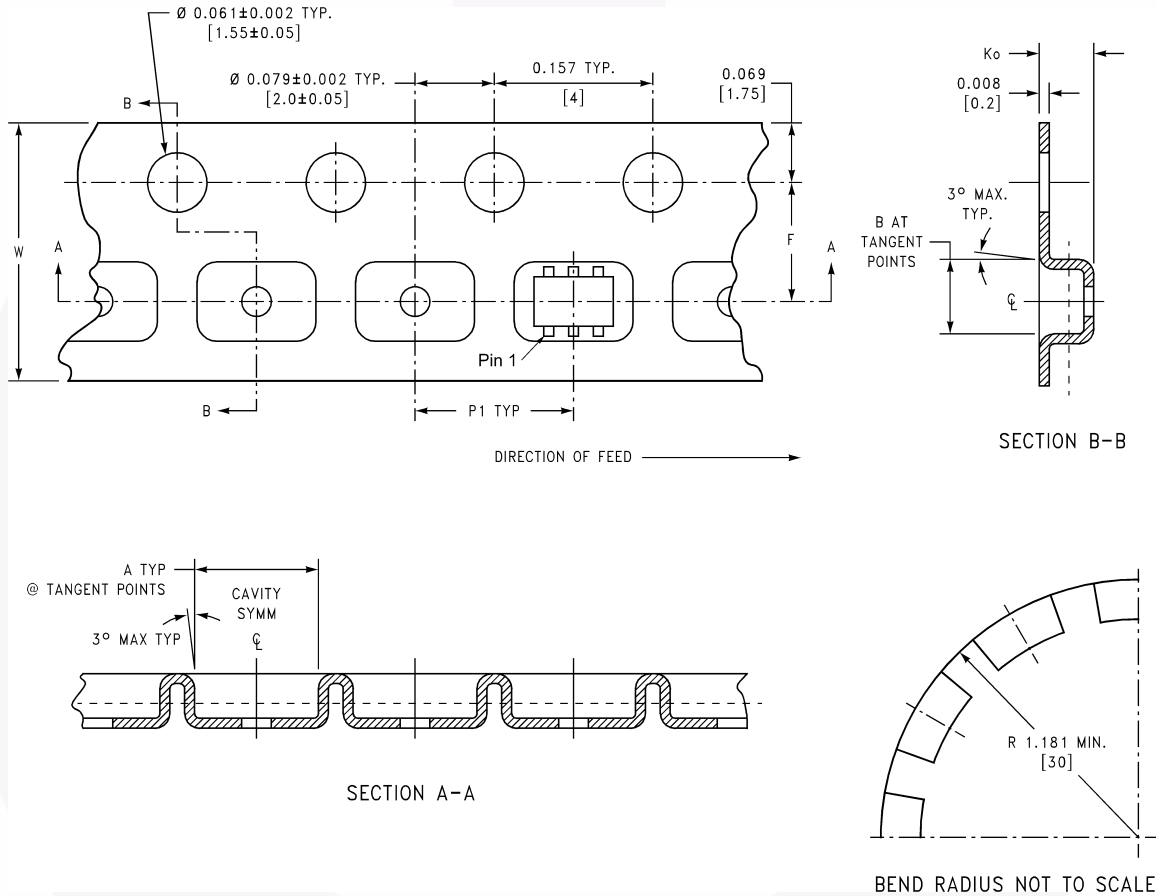

Package	Tape Size	Dim A	Dim B	Dim F	Dim K _O	Dim P1	Dim W
SC70-6	8mm	0.093 (2.35)	0.096 (2.45)	0.138 ± 0.004 (3.5 ± 0.10)	0.053 ± 0.004 (1.35 ± 0.10)	0.157 (4)	0.315 ± 0.004 (8 ± 0.1)

Tape and Reel Specification (Continued)

Tape Format for MicroPak

Package Designator	Tape Section	Number Cavities	Cavity Status	Cover Tape Status
L6X	Leader (Start End)	125 (typ.)	Empty	Sealed
	Carrier	3000	Filled	Sealed
	Trailer (Hub End)	75 (typ)	Empty	Sealed

Tape Dimension inches (millimeters)

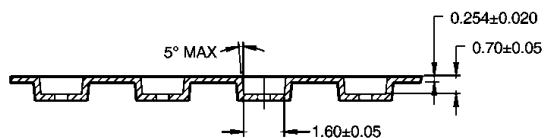
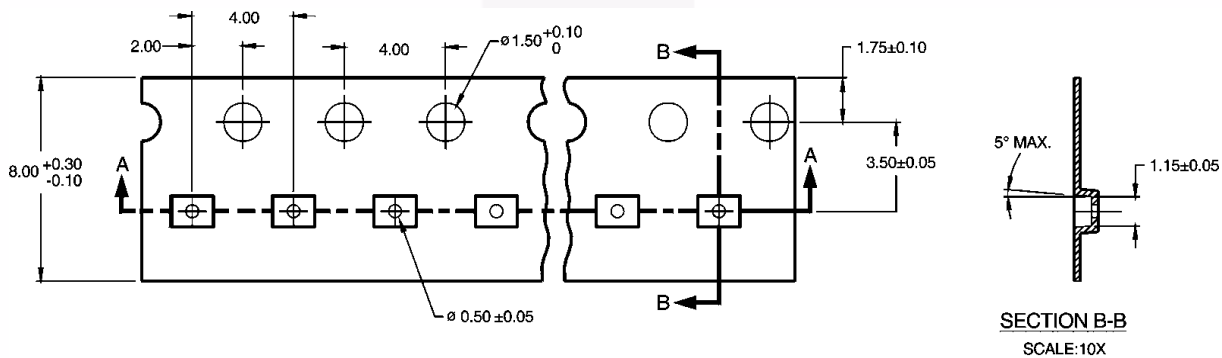

Tape and Reel Specification (Continued)

Reel Dimension for MicroPak inches (millimeters)

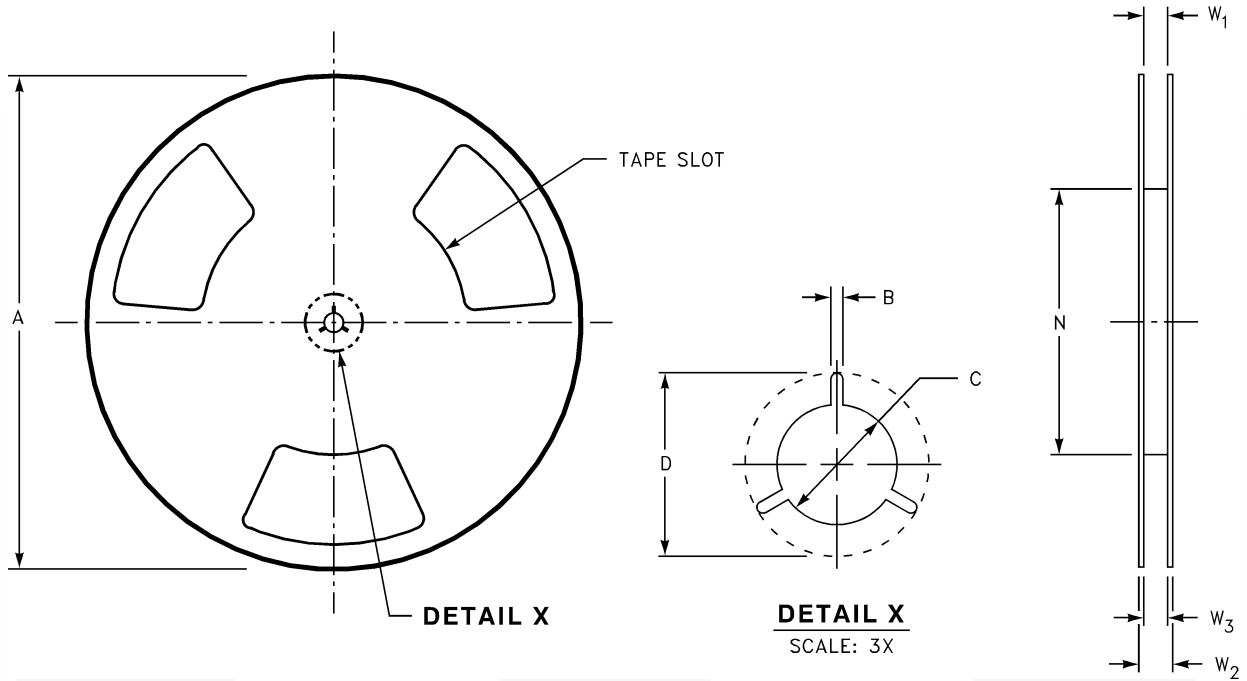

Tape Size	A	B	C	D	N	W1	W2	W3
8mm	7.0 (177.8)	0.059 (1.50)	0.512 (13.00)	0.795 (20.20)	2.165 (55.00)	0.331 + 0.059/-0.000 (8.40 + 1.50/-0.00)	0.567 (14.40)	W1 + 0.078/-0.039 (W1 + 2.00/-1.00)

Physical Dimensions

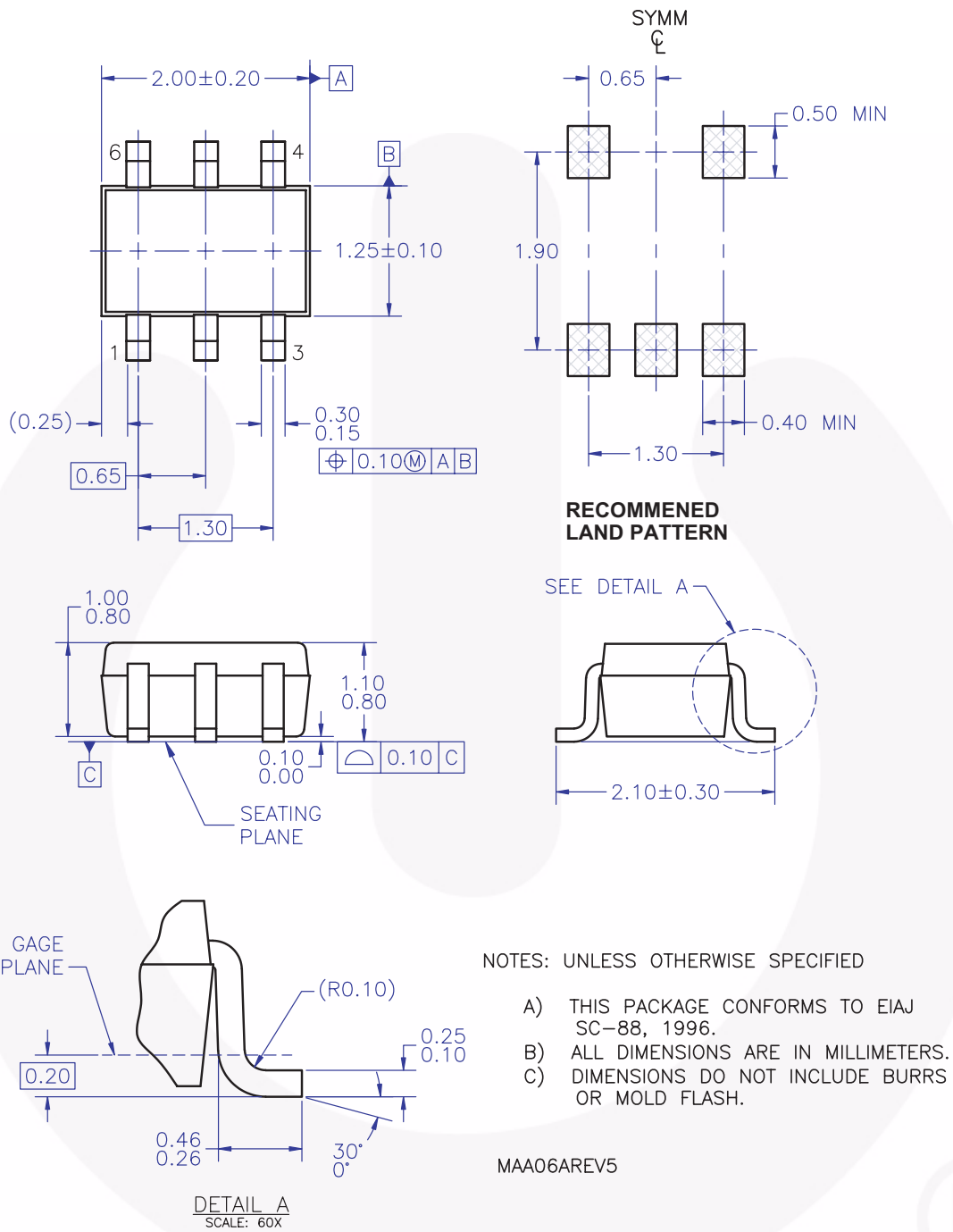

Figure 4. 6-Lead SC70, EIAJ SC88, 1.25mm Wide

Package drawings are provided as a service to customers considering Fairchild components. Drawings may change in any manner without notice. Please note the revision and/or date on the drawing and contact a Fairchild Semiconductor representative to verify or obtain the most recent revision. Package specifications do not expand the terms of Fairchild's worldwide terms and conditions, specifically the warranty therein, which covers Fairchild products.

Always visit Fairchild Semiconductor's online packaging area for the most recent package drawings:

<http://www.fairchildsemi.com/packaging/>

Physical Dimensions (Continued)

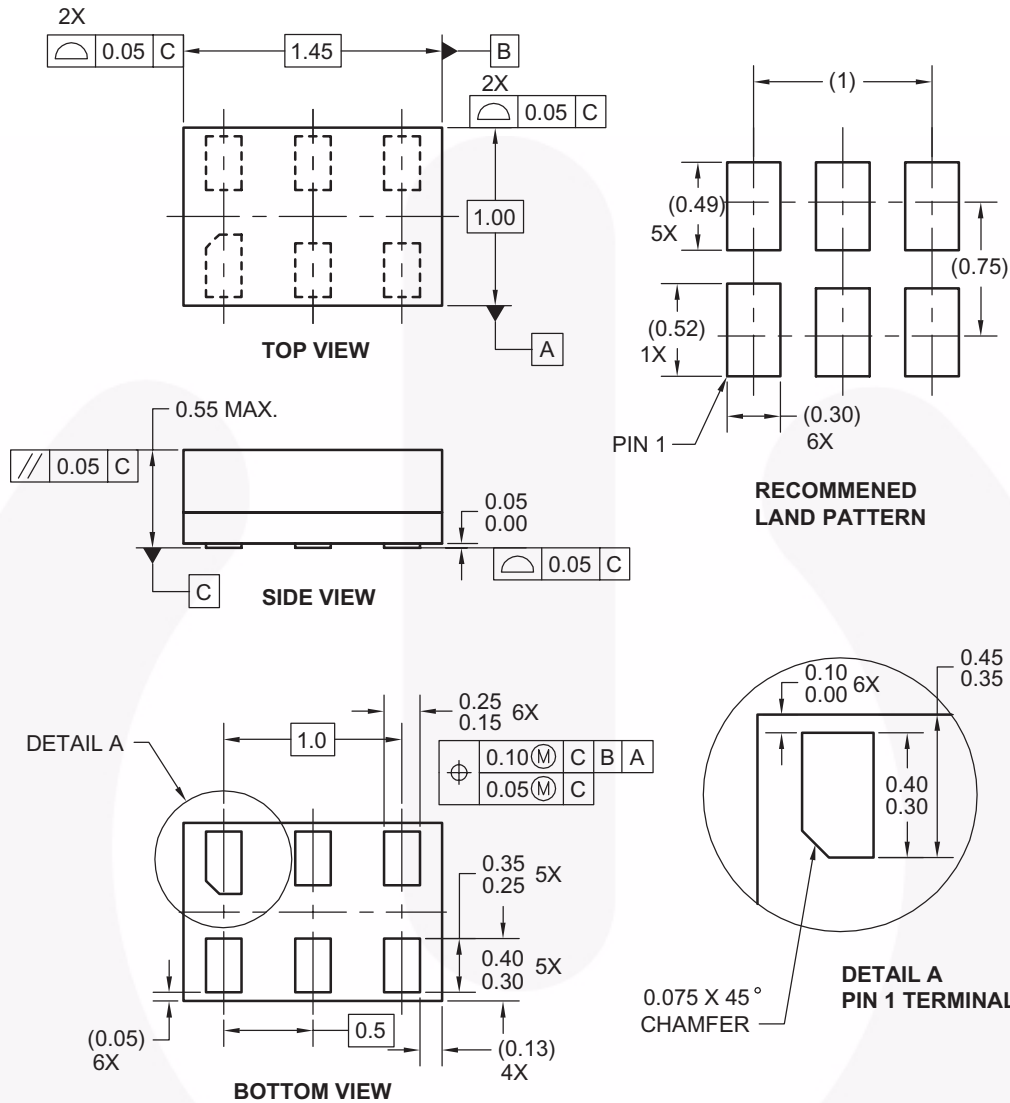

Notes:

1. CONFORMS TO JEDEC STANDARD M0-252 VARIATION UAAD
2. DIMENSIONS ARE IN MILLIMETERS
3. DRAWING CONFORMS TO ASME Y14.5M-1994

MAC06AREVC

Figure 5. 6-Lead MicroPak, 1.0mm Wide

Package drawings are provided as a service to customers considering Fairchild components. Drawings may change in any manner without notice. Please note the revision and/or date on the drawing and contact a Fairchild Semiconductor representative to verify or obtain the most recent revision. Package specifications do not expand the terms of Fairchild's worldwide terms and conditions, specifically the warranty therein, which covers Fairchild products.





Always visit Fairchild Semiconductor's online packaging area for the most recent package drawings:

<http://www.fairchildsemi.com/packaging/>



TRADEMARKS

The following includes registered and unregistered trademarks and service marks, owned by Fairchild Semiconductor and/or its global subsidiaries, and is not intended to be an exhaustive list of all such trademarks.

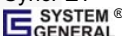
ACEx®	FPS™	PDP SPM™	The Power Franchise®
Build it Now™	F-PFS™	Power-SPM™	the power franchise
CorePLUS™	FRFET®	PowerTrench®	TinyBoost™
CorePOWER™	Global Power Resource™	Programmable Active Droop™	TinyBuck™
CROSSVOLT™	Green FPS™	QFET®	TinyLogic™
CTL™	Green FPS™ e-Series™	QS™	TINYOPTO™
Current Transfer Logic™	GTO™	Quiet Series™	TinyPower™
EcoSPARK®	IntelliMAX™	RapidConfigure™	TinyPWM™
EfficientMax™	ISOPLANAR™	Saving our world, 1mW at a time™	TinyWire™
EZSWITCH™ *	MegaBuck™	SmartMax™	μSerDes™
 ™	MICROCOUPLER™	SMART START™	
 ®	MicroFET™	SPM®	UHC®
Fairchild®	MicroPak™	STEALTH™	Ultra FRFET™
Fairchild Semiconductor®	MillerDrive™	SuperFET™	UniFET™
FACT Quiet Series™	MotionMax™	SuperSOT™-3	VCX™
FACT®	Motion-SPM™	SuperSOT™-6	VisualMax™
FAST®	OPTOLOGIC®	SuperSOT™-8	
FastvCore™	OPTOPLANAR®	SupreMOS™	
FlashWriter®		SyncFET™	
			

* EZSWITCH™ and FlashWriter® are trademarks of System General Corporation, used under license by Fairchild Semiconductor.

DISCLAIMER

FAIRCHILD SEMICONDUCTOR RESERVES THE RIGHT TO MAKE CHANGES WITHOUT FURTHER NOTICE TO ANY PRODUCTS HEREIN TO IMPROVE RELIABILITY, FUNCTION, OR DESIGN. FAIRCHILD DOES NOT ASSUME ANY LIABILITY ARISING OUT OF THE APPLICATION OR USE OF ANY PRODUCT OR CIRCUIT DESCRIBED HEREIN; NEITHER DOES IT CONVEY ANY LICENSE UNDER ITS PATENT RIGHTS, NOR THE RIGHTS OF OTHERS. THESE SPECIFICATIONS DO NOT EXPAND THE TERMS OF FAIRCHILD'S WORLDWIDE TERMS AND CONDITIONS, SPECIFICALLY THE WARRANTY THEREIN, WHICH COVERS THESE PRODUCTS.

LIFE SUPPORT POLICY

FAIRCHILD'S PRODUCTS ARE NOT AUTHORIZED FOR USE AS CRITICAL COMPONENTS IN LIFE SUPPORT DEVICES OR SYSTEMS WITHOUT THE EXPRESS WRITTEN APPROVAL OF FAIRCHILD SEMICONDUCTOR CORPORATION.

As used herein:

1. Life support devices or systems are devices or systems which, (a) are intended for surgical implant into the body or (b) support or sustain life, and (c) whose failure to perform when properly used in accordance with instructions for use provided in the labeling, can be reasonably expected to result in a significant injury of the user.
2. A critical component in any component of a life support, device, or system whose failure to perform can be reasonably expected to cause the failure of the life support device or system, or to affect its safety or effectiveness.

PRODUCT STATUS DEFINITIONS

Definition of Terms

Datasheet Identification	Product Status	Definition
Advance Information	Formative / In Design	This datasheet contains the design specifications for product development. Specifications may change in any manner without notice.
Preliminary	First Production	This datasheet contains preliminary data; supplementary data will be published at a later date. Fairchild Semiconductor reserves the right to make changes at any time without notice to improve design.
No Identification Needed	Full Production	This datasheet contains final specifications. Fairchild Semiconductor reserves the right to make changes at any time without notice to improve the design.
Obsolete	Not In Production	This datasheet contains specifications on a product that is discontinued by Fairchild Semiconductor. The datasheet is for reference information only.

Rev. I34

ON Semiconductor and  are trademarks of Semiconductor Components Industries, LLC dba ON Semiconductor or its subsidiaries in the United States and/or other countries. ON Semiconductor owns the rights to a number of patents, trademarks, copyrights, trade secrets, and other intellectual property. A listing of ON Semiconductor's product/patent coverage may be accessed at www.onsemi.com/site/pdf/Patent-Marking.pdf. ON Semiconductor reserves the right to make changes without further notice to any products herein. ON Semiconductor makes no warranty, representation or guarantee regarding the suitability of its products for any particular purpose, nor does ON Semiconductor assume any liability arising out of the application or use of any product or circuit, and specifically disclaims any and all liability, including without limitation special, consequential or incidental damages. Buyer is responsible for its products and applications using ON Semiconductor products, including compliance with all laws, regulations and safety requirements or standards, regardless of any support or applications information provided by ON Semiconductor. "Typical" parameters which may be provided in ON Semiconductor data sheets and/or specifications can and do vary in different applications and actual performance may vary over time. All operating parameters, including "Typicals" must be validated for each customer application by customer's technical experts. ON Semiconductor does not convey any license under its patent rights nor the rights of others. ON Semiconductor products are not designed, intended, or authorized for use as a critical component in life support systems or any FDA Class 3 medical devices or medical devices with a same or similar classification in a foreign jurisdiction or any devices intended for implantation in the human body. Should Buyer purchase or use ON Semiconductor products for any such unintended or unauthorized application, Buyer shall indemnify and hold ON Semiconductor and its officers, employees, subsidiaries, affiliates, and distributors harmless against all claims, costs, damages, and expenses, and reasonable attorney fees arising out of, directly or indirectly, any claim of personal injury or death associated with such unintended or unauthorized use, even if such claim alleges that ON Semiconductor was negligent regarding the design or manufacture of the part. ON Semiconductor is an Equal Opportunity/Affirmative Action Employer. This literature is subject to all applicable copyright laws and is not for resale in any manner.

PUBLICATION ORDERING INFORMATION

LITERATURE FULFILLMENT:

Literature Distribution Center for ON Semiconductor
19521 E. 32nd Pkwy, Aurora, Colorado 80011 USA
Phone: 303-675-2175 or 800-344-3860 Toll Free USA/Canada
Fax: 303-675-2176 or 800-344-3867 Toll Free USA/Canada
Email: orderlit@onsemi.com

N. American Technical Support: 800-282-9855 Toll Free
USA/Canada
Europe, Middle East and Africa Technical Support:
Phone: 421 33 790 2910
Japan Customer Focus Center
Phone: 81-3-5817-1050

ON Semiconductor Website: www.onsemi.com
Order Literature: <http://www.onsemi.com/orderlit>
For additional information, please contact your local
Sales Representative