



Eval Kit Manual

PCap04

Standard Board

PCAP04-EVA-KIT

Content Guide

1	Introduction	3
2	Quick Start Guide	5
2.1	Install the Software.....	5
2.2	Install the Hardware:	5
2.3	Quick Start for Initial Measurements.....	6
3	Hardware Description.....	9
3.1	Connecting Capacitors and Resistors.....	9
3.2	Hardware Architecture	9
3.2.1	PCAP04 BOARD.....	9
3.2.2	Temperature Measurement	10
3.2.3	Pulse Code Generation.....	12
3.2.4	Motherboard.....	12
4	Software Description	13
4.1	Initialization	13
4.2	Graphical User Interface	13
4.2.1	Front Panel.....	13
4.2.2	Front Panel Menus.....	26
4.2.3	Special Windows.....	30
4.2.4	Linearize.....	37
4.2.5	Assembler	42
4.3	Scaling Results	42
4.4	Scaling PDM Output.....	44
5	Schematics, Layers and BOM	45
6	Ordering & Contact Information	49
7	Copyrights & Disclaimer.....	50
8	Revision Information	51

1 Introduction

The PCAP04-EVA-KIT evaluation system provides a complete system for generally evaluating the PCap04 IC. It is supplied with a main board, a plug-in board, a Windows based evaluation software, assembler software and the PICOPROG V3.0 programming device. The PCap04 evaluation board is connected to the PC's USB interface through the PICOPROG V3.0 programming device. The previous generation PICOPROG V2.0 programming device may also be used with the PCAP04-EVA-KIT.

Figure 1: Kit Content

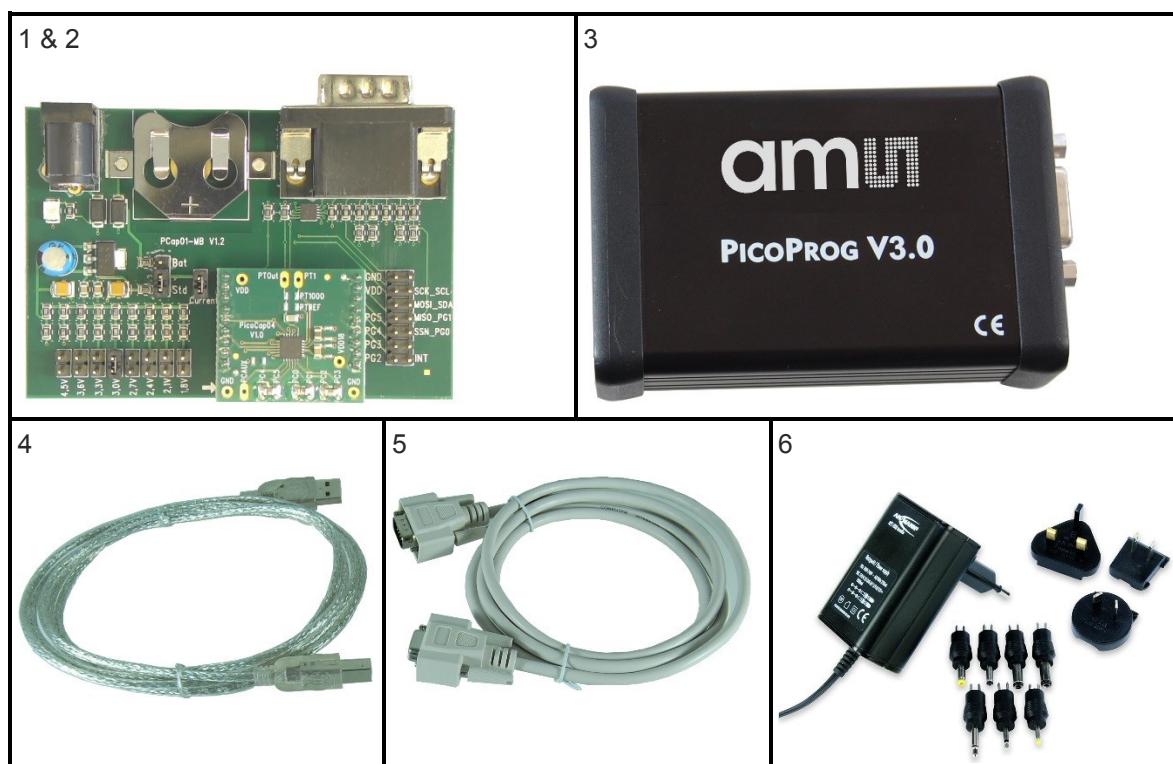

Pos.	Item	Comment
1	PCap01-MB	Motherboard
2	PCap04-EVA-BOARD	Plug-in board based on PCap04 in QFN24 package
3	PICOPROG V3.0	Programmer and interface box
4	USB cable	Connects PICOPROG V3.0 to PC
5	High density DSUB15 cable	Connecting Evaluation board to programmer (optionally)
6	Wall power supply unit	9 V

The evaluation kit offers user-friendly operation of the PCap04 single-chip solution for capacitance measurement. This kit can be used to evaluate the capacitance measurement, temperature measurement and the pulse generation capabilities of the PCap04 chip. The kit also includes a CD-

ROM containing software and data sheets. However, it is strongly recommended to use the latest data sheets and GUI software or get them on request.

2 Quick Start Guide

In this section, we described how to set up quickly the PCAP04-EVA-KIT and establish basic operation and make measurements.

2.1 Install the Software

It is crucial to install the software before connecting the evaluation kit to your computer. A default driver loading of your OS may interfere with correct installation.

- Download the latest zipped software installation package to the desired directory.
- Unzip the package to the desired directory.
- Open “setup.exe” from the unzipped directory.
- Follow the instructions on the screen.

2.2 Install the Hardware:

- Install the software before proceeding with this step!
- Connect your computer with the PICOPROG V3.0 using USB cable.
- Connect PICOPROG V3.0 and the evaluation kit motherboard using the DB15 interfaces
- Mount the plug-in board on the corresponding socket on the motherboard.
- Set the power supply unit to 7.5 V output.
- Connect the motherboard to power via the power supply unit. The green LED on the EVA kit motherboard should be on.

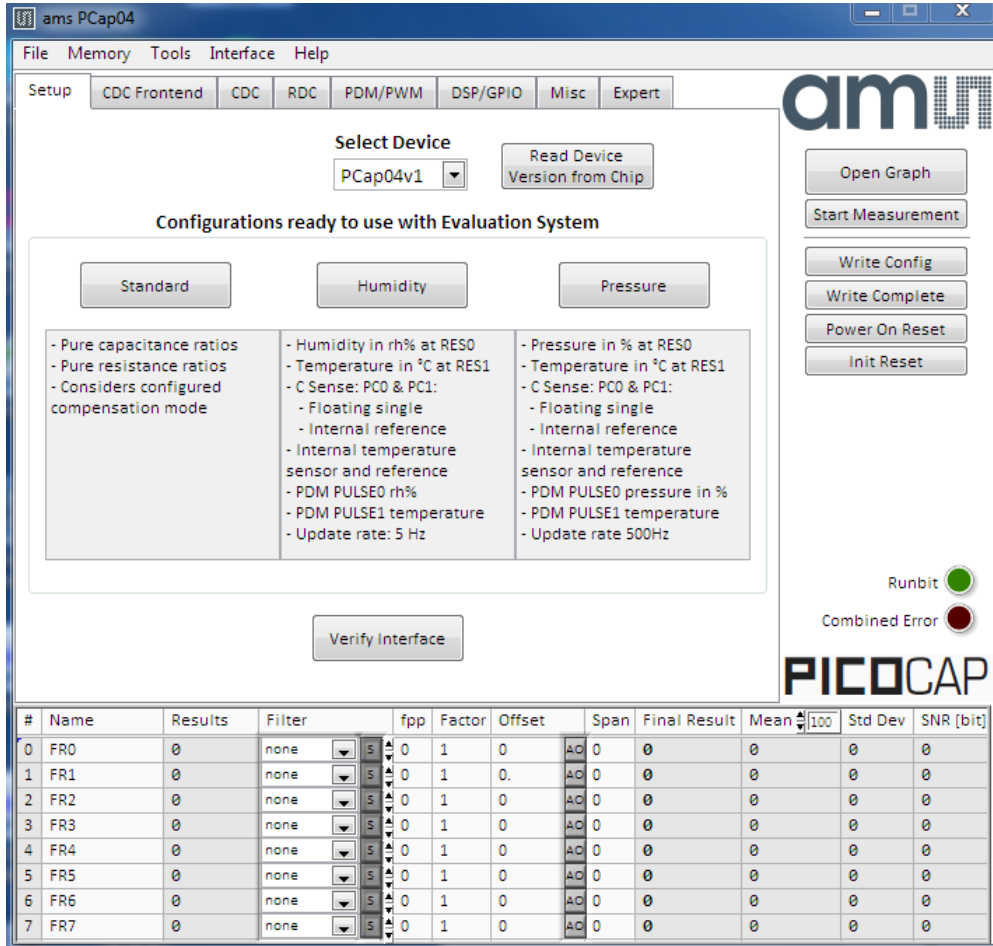

Figure 2: Connected PCAP04-EVA-KIT

2.3 Quick Start for Initial Measurements

From the “Start” menu, go to “All Programs” and then to the “acam” directory. Double click the “PCap04 Frontpanel” icon to begin execution of the evaluation kit software. The following screen should appear:

Figure 3: Setup page



Click the “Verify Interface” Button to confirm communication with PICOPROG V3.0 is working:

Figure 4: Verify Message



The PCap04 plug-in board is pre-assembled with ceramic capacitors to emulate capacitive sensors. These capacitors, each 10 pF in value, are connected to the 6 ports PC0 to PC5.

To begin measurements using these preinstalled components, it is necessary to make the following adjustments on the “CDC Frontend” tab:

1. “Capacitive Measurement Scheme” section should be set to “Floating | Single”.
2. All the capacitance ports should be turned on using the Cap. Port. Select buttons
3. The Stray Compensation setting should be set to “Both”.

The resulting settings under the CDC tab should look like this:

Figure 5: CDC Frontend page at the start

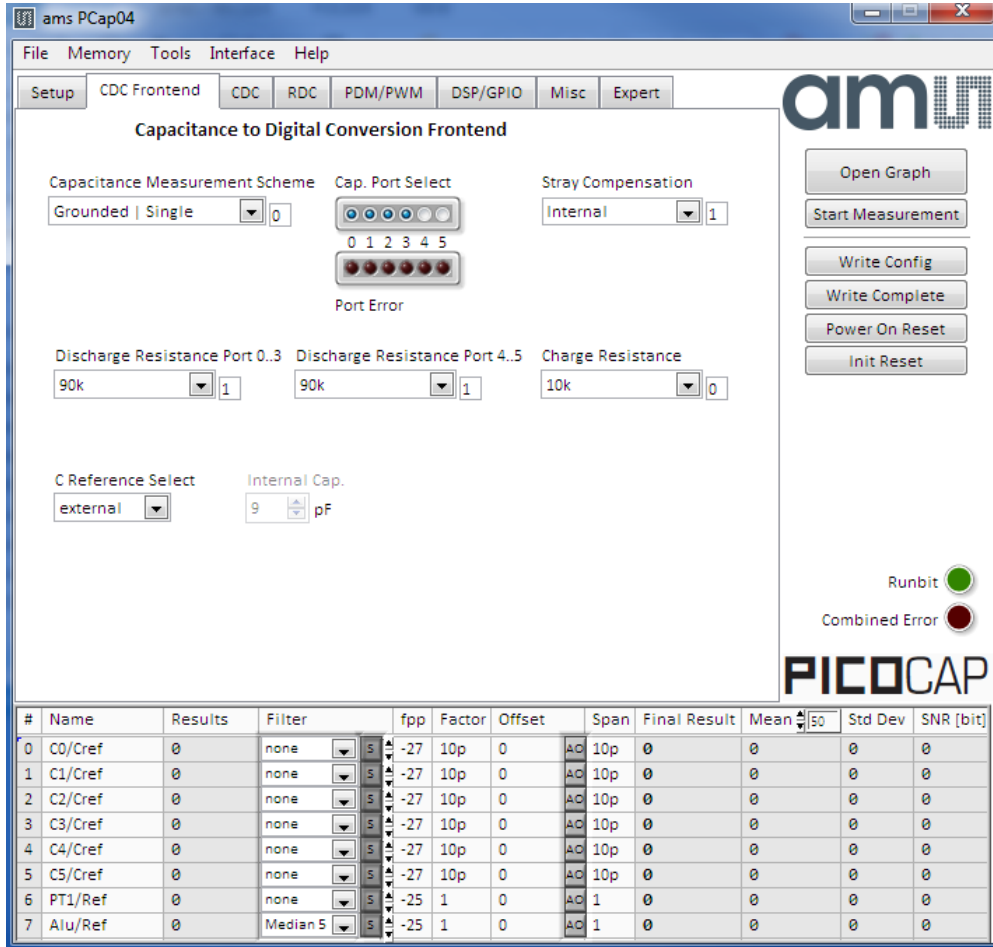

To begin measurements, on the right side of the window, click the following buttons in the order listed:

1. "Power On Reset"
2. "Write Complete"
3. "Start Measurement"

Measurements should now be running and your screen should resemble the following:

Figure 6: CDC Frontend page in use

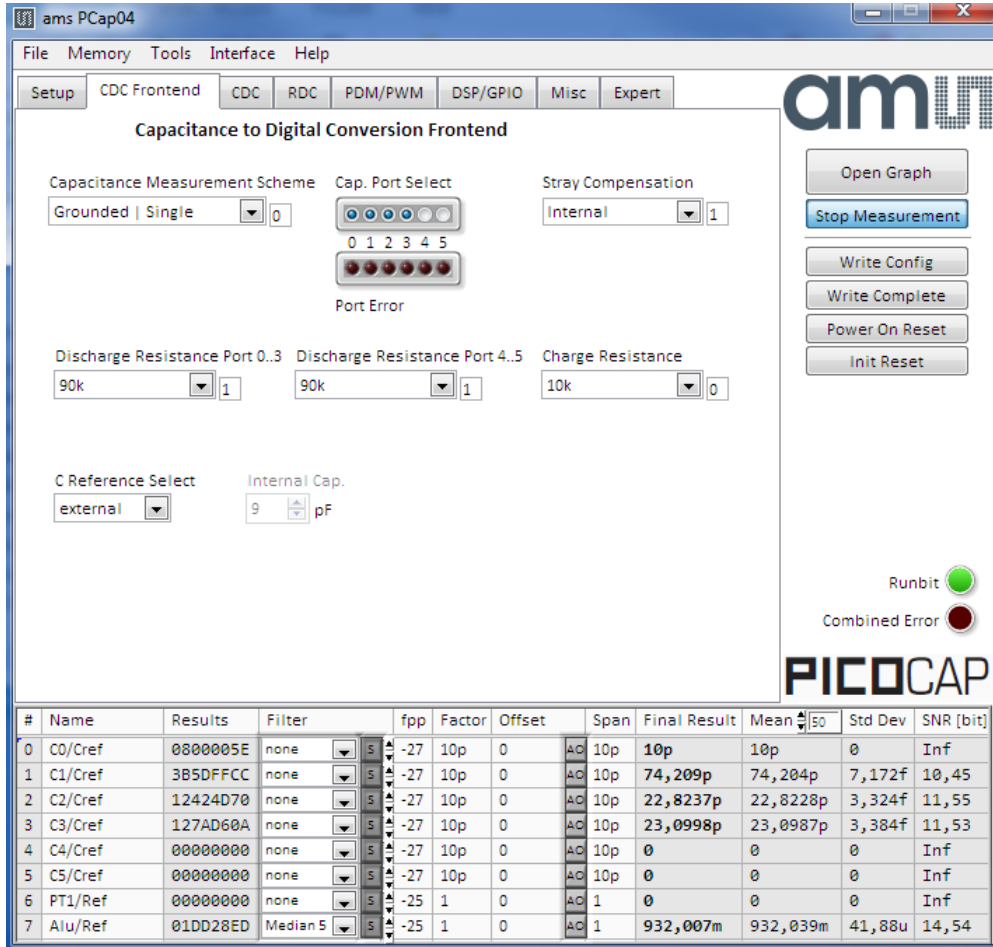

The C1 and C2 values should be continually updating but remain within a reasonably small standard deviation as shown.

At this point if the above steps have been successfully completed basic operation of the EVA kit should be achieved. The following sections provide a detailed description of the hardware and software for advanced operation.

3 Hardware Description

3.1 Connecting Capacitors and Resistors

This evaluation kit can be used for evaluating capacitance measurement by connecting capacitive sensors. Further, it can be used for evaluating temperature measurement by connecting external temperature sensitive resistors or for generating quasi analog voltage (pulse width/density modulated) that is dependent on the sensor connected to the system.

Depending on the purpose of evaluation, a modification has to be made to the same plug-in board. Following is a picture of the Mother board with the plug-in board.

Figure 7: The evaluation kit's motherboard and plug-in board

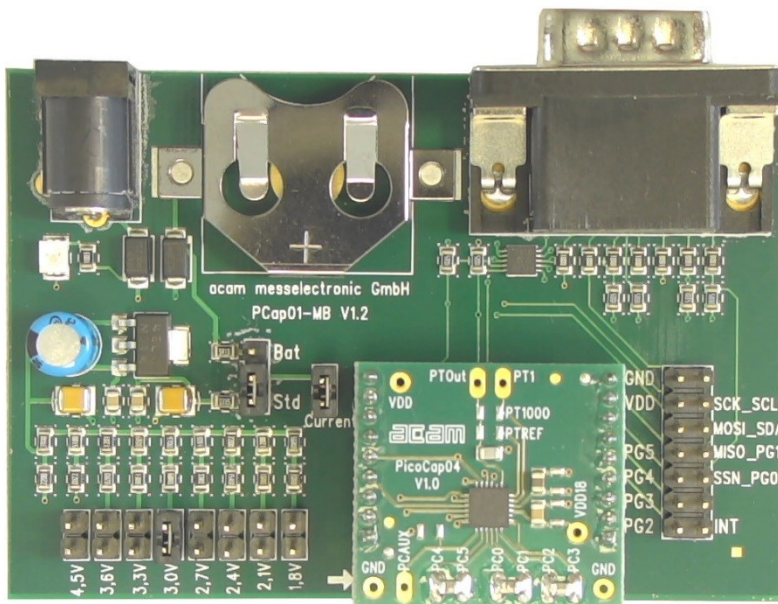

The following sections describe the modifications for each application in detail.

3.2 Hardware Architecture

3.2.1 PCAP04 BOARD

For the purpose of evaluating the capacitance measurement using PCap04, the plug-in board is pre-assembled with ceramic capacitors to emulate capacitive sensors. These capacitors, each 10 pF in value, are connected to the 6 ports PC0 to PC5. They are connected as single sensors in floating mode, i.e. each capacitor is connected between 2 ports, and hence there are 3 x 10 pF on-board capacitors. Please refer to section 3 of the PCap04 data sheet for more information on how to connect capacitors to the chip. In case using external reference, the capacitor connected between ports PC0 and PC1 is taken as the reference capacitor.

Figure 8: Details of the plug-in board (A=three C0G ceramic capacitors)

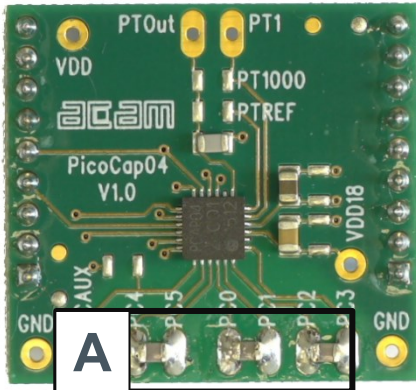

In the process of evaluation, when you are comfortable with interpreting the measurement results from the chip, these fixed capacitors can be replaced with the actual capacitive sensors of your application.

If you want to connect your capacitive sensors in grounded mode, then GND points are provided at the two ends of the board, where the sensor ground connections ought to be soldered.

The typical value of the capacitive sensors that can be connected to the evaluation kit lies in the range of 30 pF to 3.5 nF. The reference capacitor should be in the same order of magnitude as the sensor. Depending on the value of the sensor, the value of the internal resistor for performing the measurement has to be selected. For the pre-assembled 10 pF capacitors, an internal discharge resistor of 90 kΩ works well. See section 3 of the PCap04 data sheet on how to select the value of the internal discharge resistor.

3.2.2 Temperature Measurement

Temperature measurement or other resistive tasks may also be of interest for the user of this kit. The evaluation kit offers this possibility through the RDC (resistive-to-digital converter) ports. An on-chip thermistor coupled with an on-chip temperature-stable reference resistor made of polysilicon is sufficient for observing the temperature measurement capability of the PCap04 chip.

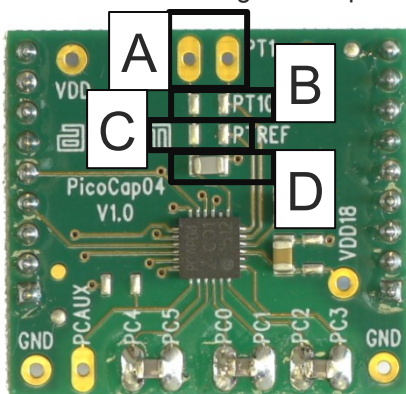

Figure 9 Temperature sensor connection pads

Pos.	Item	Comment
A	Port PT1 for second external temperature sensor	not supported by the standard firmware
B	Port PT0 for external temperature sensor	
C	Port PT2 for external reference resistor	
D	10 nF COG	

However, there is a possibility to connect the reference resistor and the thermistor externally to the chip, too. In case of external resistors, the temperature-stable reference resistor ought to be connected at port PT2REF on the plug-in board. The board allows you to connect the external thermistor, e.g. a PT1000 sensor at port PT0 (or PT1, not supported yet by the standard firmware). In any case, for the temperature measurement, an external capacitor 10 nF COG has to be connected to the chip; it is already pre-assembled on board.

3.2.3 Pulse Code Generation

Any of the capacitance or temperature measurement results from the PCap04 chip can be given out as a pulse width modulated or pulse density modulated signal. This output can be filtered to generate an analog output signal that can be used for further controlling.

These pulse width or pulse density codes can be generated at Ports PG0, PG1, PG2 or PG3 (in block A). Since ports PG0 and PG1 are used for the SPI Interface in the board, the hardware allows to get a valid pulse width/density modulated signal on PG2 or PG3. However, when I2C communication mode is used the pulsed signals can be optionally obtained on the ports PG0 and PG1.

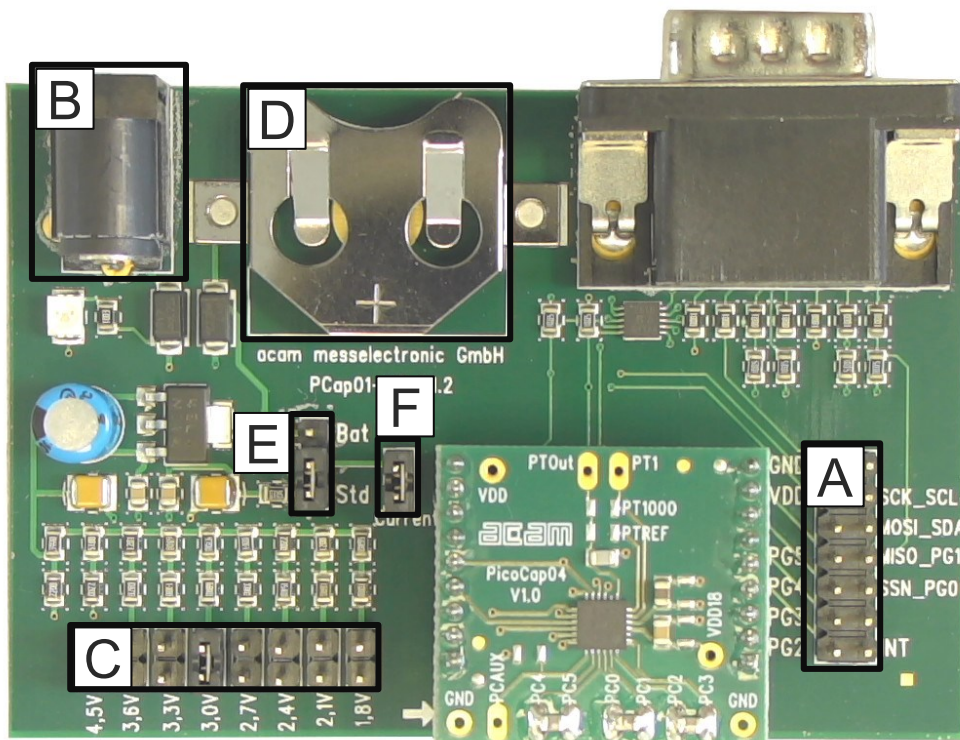

Figure 10 General purpose interface ports PG0 to PG3 in block A

3.2.4 Motherboard

The motherboard connects to the PICOPROG V3.0 programmer. It serves the various power options. It can be powered via wall plug supply (B), the voltage being set from 1.8 V to 4.5 V by jumpers (C). Further, it supports a battery power option (D). The power options are switchable via jumper (E). Power present is indicated by a green LED.

There is a jumper 'Current' on the mother board (F). The current consumption of the PCap04 chip during operation can be directly measured from these jumper terminals.

All interface signals and general purpose I/O signals can be monitored by means of a separate jumper in block A.

4 Software Description

4.1 Initialization

Configuration files, Firmware, Settings and calibration data are subsumed in a project (.prj) file. When opening a project file then automatically the configuration and firmware data will be transferred to the chip and the chip is initialized.

Step 1: The first to do after starting the evaluation software is to read the device version from Chip by pressing the button or to select the supported PICOCAP device on the setup page. In the initial phase start with our standard firmware that calculates the capacitance ratios and resistance ratios. It automatically recognizes the operation mode and takes care of the set number of capacitors and the kind of connection. But it does no further processing.

Step 2: If you want to change from the default SPI to I2C interface, please select under Interface --> Bus --> I2C. The LED on the PICOPROG V3.0 programmer should now turn red. When the LED does not glow at all, then it indicates that the interface is faulty.

Step 3: By pressing the 'Standard'-button, the standard project file will be open.

You also may load your own project file.

Step 4: Open Graph window and press 'Start Measurement'.

4.2 Graphical User Interface

Next, the main front panel comes up. Overall, the graphical user interface offers various windows for on-line configuration, for parameter and calibration data setting, and of course for the graphical and numerical display of the measurement data. The various windows will be explained in this chapter.

4.2.1 Front Panel

This is the main window. On the right side, the front panel shows six general buttons:

Open Graph	Open a window for graphic representation of measurement data
Start Measurement	Start or stop a running measurement
Write Config.	Transfer once more, the present settings in the evaluation software to the chip (in case of doubt)
Write Complete	Transfer the complete firmware, calibration data and configuration to the chip
Power On Reset	After Power up reset, 'Write Config.' may be necessary.
Init Reset	With an init reset, the chip is re-initialized with respect to its frontend and processor.

4.2.1.1 Setup Page

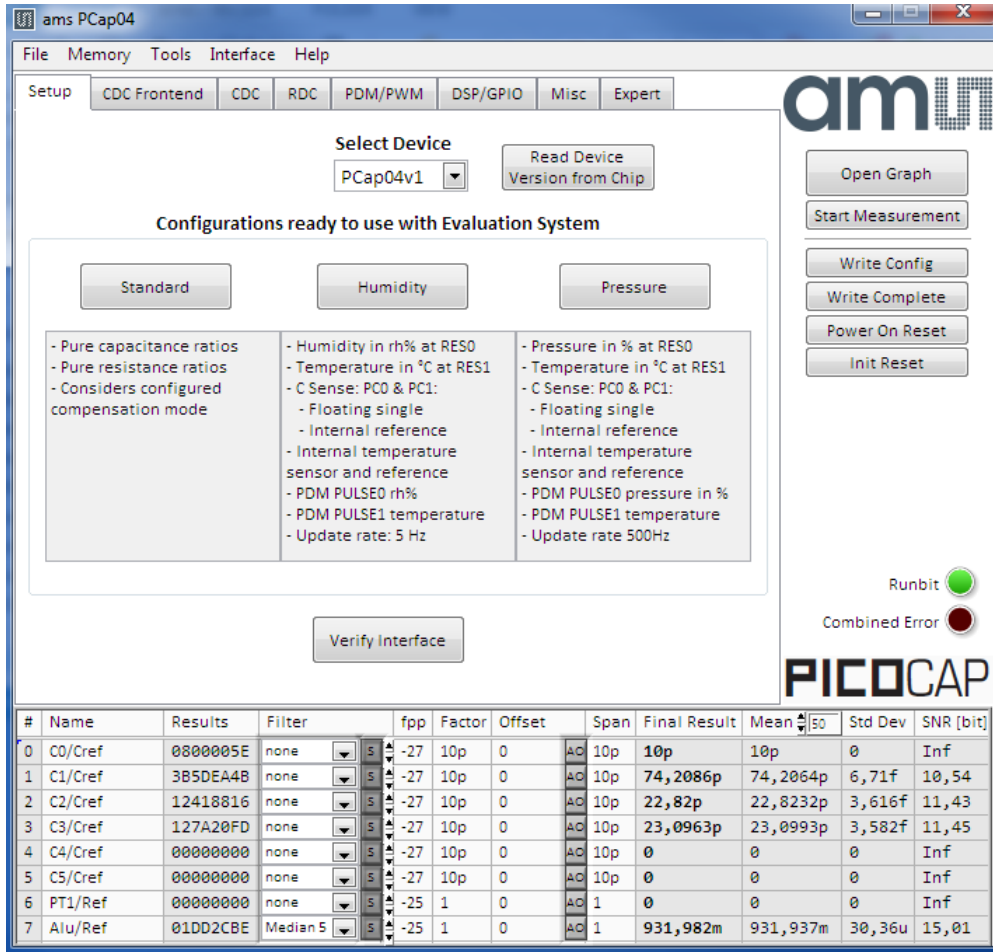

Figure 11 Setup page

Options on 'Setup' page:

Select Device	Select the PICOCAP device which you use. <PCap04v0> means silicon version "Z" <PCap04v1> means release silicon version "v1"
Read Device Version from Chip	Reads the device version from chip
Standard	Opens the <Selected Device>_standard.prj project file with configuration and standard firmware.
Humidity	Opens the <Selected Device>_humidity.prj project file with configuration and linearization firmware.
Pressure	Opens the <Selected Device>_pressure.prj project file with configuration and linearization firmware.

Verify Interface	When everything is in order, then pressing this button will indicate the release version number of the software and of the PICOPROG V3.0 Firmware. It also confirms with 'Memory read/write: OK' if a supported PICOCAP device is present.
------------------	--

The lower part of the window is used for real-time numerical display of the measurement results. In principal it shows the content of the read registers. The content itself depends on the firmware. Figure 1-16 shows the content as it is given with the standard firmware. The first six rows show the capacitance ratios, the last two rows show the temperature result (resistance ratio or linearized temperature).

The tab has 12 columns of information, defining labels, data format, resolution specification (white background) and results (grey background). The information in the white fields increase convenience of reading and is stored in the project files (*.prj). All number may get a character to indicate the well-known prefixes for denoting the factor in thousands ('p', 'f', 'a', 'k'...).

Name	Label for the register content, depends on the firmware.
Results	Raw hex data display of the result register content. The column before shows the width. The button column after shows whether the result is signed or unsigned.
Filter	Selection of various software filters like Sinc (rolling average) and Median (non-linear filter).
fpp	This column shows the size of the fractional part of the fixed point number and the necessary shift. Depends on the firmware.
Factor	The factor is a scaling factor that allows to scale the result according to the reference capacitor. Factor = '1' gives back the initial capacitance ratio in column 'Final Result'.
Offset	Offset to be added or subtracted in the evaluation software.
Auto Offset	By pressing [AO], the software re-calculates the 'Offset', setting back the 'Final Result' to 0
Span	Number that defines the maximum span of the sensor. Is relevant only for the calculation of the resolution in column SNR [bit].
Final Result	Display of the final result, scaled by 'Factor' and the 'Offset' added.
Mean	Display of the mean value. The sample size can be selected.
Std.Dev	Standard deviation of the 'Final Result'.
SNR [bit]	Signal-to-Noise ratio in bit, calculated as 'Span'/'Std.Dev.'

4.2.1.2 CDC Frontend Page

The screenshot shows the 'CDC Frontend' configuration page in the 'ams PCap04' application. The page is titled 'Capacitance to Digital Conversion Frontend' and includes several configuration sections:

- Capacitance Measurement Scheme:** Grounded | Single (dropdown), 0 (input)
- Cap. Port Select:** A diagram of six ports (0-5) with port 0 selected.
- Stray Compensation:** Internal (dropdown), 1 (input)
- Discharge Resistance Port 0..3:** 90k (dropdown), 1 (input)
- Discharge Resistance Port 4..5:** 90k (dropdown), 1 (input)
- Charge Resistance:** 10k (dropdown), 0 (input)
- C Reference Select:** external (dropdown)
- Internal Cap.:** 9 pF (input)

On the right side, there are control buttons: Open Graph, Stop Measurement, Write Config, Write Complete, Power On Reset, and Init Reset. Below these are status indicators for 'Runbit' (green circle) and 'Combined Error' (red circle).

At the bottom, a table displays measurement results:

#	Name	Results	Filter	fpp	Factor	Offset	Span	Final Result	Mean	Std Dev	SNR [bit]
0	C0/Cref	0800005E	none	s	-27	10p	0	10p	10p	0	Inf
1	C1/Cref	3B5DF FCC	none	s	-27	10p	0	74,209p	74,204p	7,172f	10,45
2	C2/Cref	12424D70	none	s	-27	10p	0	22,8237p	22,8228p	3,324f	11,55
3	C3/Cref	127AD60A	none	s	-27	10p	0	23,0998p	23,0987p	3,384f	11,53
4	C4/Cref	00000000	none	s	-27	10p	0	0	0	0	Inf
5	C5/Cref	00000000	none	s	-27	10p	0	0	0	0	Inf
6	PT1/Ref	00000000	none	s	-25	1	0	0	0	0	Inf
7	Alu/Ref	01DD28ED	Median 5	s	-25	1	0	932,007m	932,039m	41,88u	14,54

Figure 12 CDC Frontend page

Options on 'CDC Frontend page:

Capacitance Measurement Scheme	<p>Grounded Single – Single capacitive sensor connected between a port and ground.</p> <p>Grounded Differential – Differential capacitive sensor connected between 2 ports with the middle tap of the sensor connected to ground.</p> <p>Floating Single – Single capacitive sensor connected between 2 ports.</p> <p>Floating Differential – Differential capacitive sensor connected between 2 ports with the middle tap of the sensor connected to another 2 ports.</p>
Cap. Port Select	Select which capacitive ports have to be measured (Ports 0-5), i.e. at which ports the sensors have been connected in hardware.
Stray Compensation	<p>None – No compensation</p> <p>Internal – One additional measurement performed through only the chip-internal stray capacitance with respect to ground.</p> <p>External – One additional measurement per port pair, performed through a parallel connection of the capacitance at the two ports with respect to ground.</p> <p>Both – Both internal and external compensation together.</p>
Discharge Resistance Port 0..3	Selects the value of the internal resistance (180k, 90k, 30k, 10k) for measurements on port PC0 to PC3 through which the discharge cycles during measurement are to be performed. This value has to be selected in accordance with the capacitance value of the sensor.
Discharge Resistance Port 4..5	Selects the value of the internal resistance (180k, 90k, 30k, 10k) for measurements on port PC4 to PC5 through which the discharge cycles during measurement are to be performed. This value has to be selected in accordance with the capacitance value of the sensor.
Charge Resistance	Choice of one out of 4 on-chip charging resistors (180k, 10k) for the CDC. Permitting to limit the charging current and avoiding transients.
C Reference Select	Switching between external and internal reference capacitance.
Internal Cap	Selection of internal reference capacitance value. (0..31pF)

4.2.1.3 CDC Page

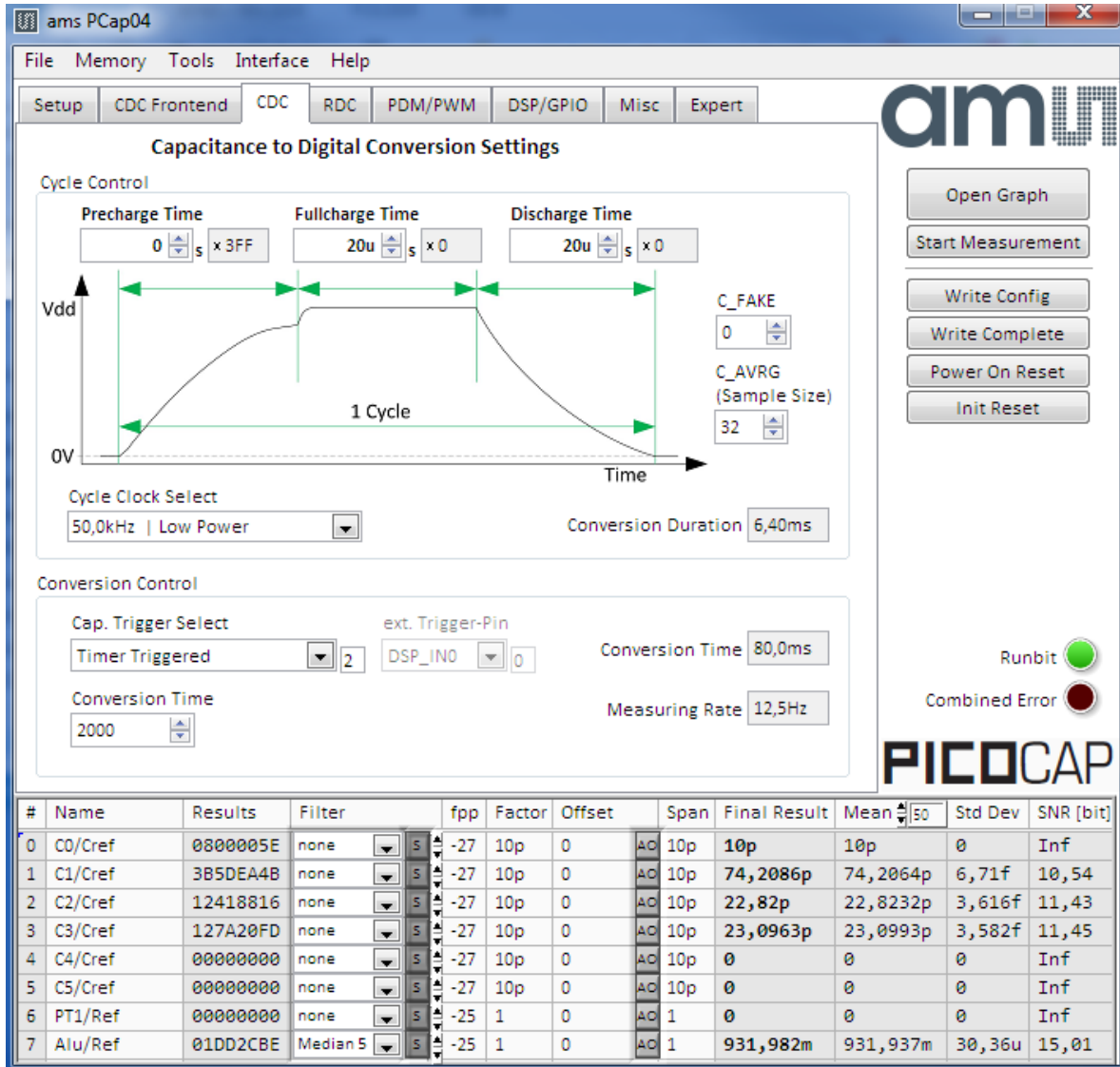

Figure 13 CDC page

Options on 'CDC page:

Cycle Control

Precharge Time	Time to charge via resistor for current limitation, can be set in multiples of the cycle clock
Fullcharge Time	Time for final charge without current limitation, can be set in multiples of the cycle clock
Discharge Time	Time to discharge the capacitor, can be set in multiples of the cycle clock
C_FAKE	Number of fake measurements per measurement cycle. Performing fake measurements may help in reducing noise.

C_AVRG	Enables averaging the measurement results over multiple measurement cycles. Setting to 1 → No averaging, Setting to any number N, will result in averaging over N measurement cycles for generating one measurement result. (0..8191)
Cycle Clock Select	50,0kHz Low Power – Single capacitive sensor connected between a port and ground. 500kHz High Speed/4 – Differential capacitive sensor connected between 2 ports with the middle tap of the sensor connected to ground. 2,00MHz High Speed – Single capacitive sensor connected between 2 ports.
Conversion Duration	Displays the entire conversion duration per cycles for averaging and fake measurements.
C_TRIG_SEL	Selects the source that triggers the start of a capacitance measurement Continuous – Continuous measurement, self-triggering. Recommended when no temperature measurement is made in parallel. Read Triggered – Triggered by read out Timer Triggered – Depending on the setting the 'Conversion Time'. Generally recommended setting → less prone to error conditions. Timer Triggered (Stretched) – Depending on the setting the CONV_TIME. The parameter is used as sequence period. Pin triggered – Triggered by external Pin, selectable from option ext.Trigger-Pin Opcode Triggered Off – Started by SPI Command 0x8C Continuous (exp.) – (not recommended)
Ext. Trigger-Pin	Used to select the pin to be used as the source of trigger for the capacitance measurement. NOTE: In the delivered EVA board, the pins DSP_IN0 and DSP_IN1 are part of the SPI communication interface, hence only DSP_IN2 and DSP_IN3 selections are relevant.

Conversion Control

CONV_TIME	Sets the conversion time in multiples of twice the period of the low-frequency clock
Conversion Time	Displays the entire conversion time per measurement.
Measuring rate	Displays the frequency at which capacitive measurement data is transferred from the DSP to the interface (SPI or I2C).

4.2.1.4 RDC Page

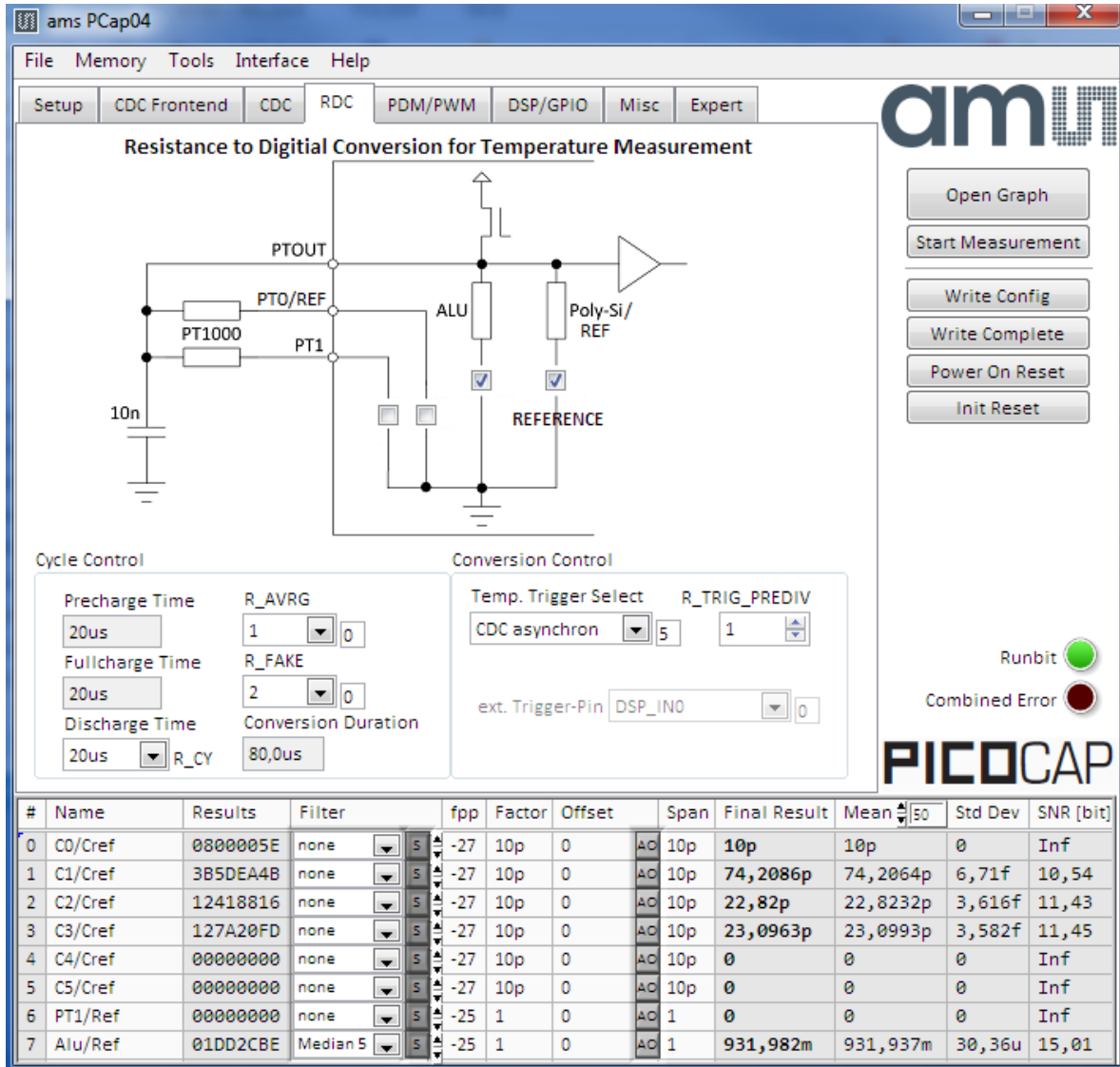

Figure 14 RDC page

Options on 'RDC' page:

Temp.Sensor0	To select a thermistor connected to port PT0/REF for temperature measurement. This could be e.g. an external PT1000.
Temp.Sensor1	To select a thermistor connected to port PT1 for temperature measurement.
Temp.Sensor2	To select either the internal aluminum (ALU) thermistor for temperature measurement.
Reference	To select either the internal Poly-Si thermistor or an external reference resistor at port PT0/REF for temperature measurement.

Cycle Control

Precharge Time	Displays the precharge time. It depends on R_OLF_DIV.
Fullcharge Time	Displays the fullcharge time It depends on R_OLF_DIV.
Discharge Time	Set the discharge time. It depends on R_OLF_DIV.
R_AVRG	Set averaging for temperature measurement.
R_FAKE	Set number of fake measurements per temperature measurement cycle.
Conversion Duration	Displays the entire conversion duration per cycles for averaging and fake measurements.

Conversion Control

Temp. Trigger Select	<p>Selects the source that triggers the start of a temperature measurement</p> <p>Off: Default setting when no temperature measurement is wanted. In this case, a temperature measurement can still be started by SPI Command 0x8E.</p> <p>OLF_CLK: Triggered by Low-frequency oscillator.</p> <p>Pin-Triggered: Triggered by external Pin, selectable from option ext.Trigger-Pin</p> <p>CDC asynchronous: Depending on the setting in the 'T_TRIG_PREDIV' counter on the RDC page. The DSP is triggered by the RDC end of conversion. If RDC rate is less than CDC rate the DSP is triggered directly from the CDC for inactive RDC conversions.</p> <p>CDC synchronous: Depending on the setting in the 'T_TRIG_PREDIV' counter on the RDC page. The DSP is triggered by the RDC end of conversion. Assuming that RDC rate is less than the CDC rate, the inactive RDC conversions are replaced by a delay.</p>
R_TRIG_PREDIV	For CDC and OLF options the RDC measure rate can be reduced by setting a divider.
Conversion Time	Displays the entire conversion time per measurement.
Measuring Rate	Displays the frequency at which capacitive measurement data is transferred from the DSP to the interface (SPI or I2C).
Ext. Trigger-Pin	<p>Used to select the pin to be used as the source of trigger for the capacitance measurement.</p> <p>NOTE: In the evaluation board, the pins DSP_IN0 and DSP_IN1 are part of the SPI communication interface, hence only DSP_IN2 and DSP_IN3 selections can be used.</p>

4.2.1.5 PDM / PWM Page

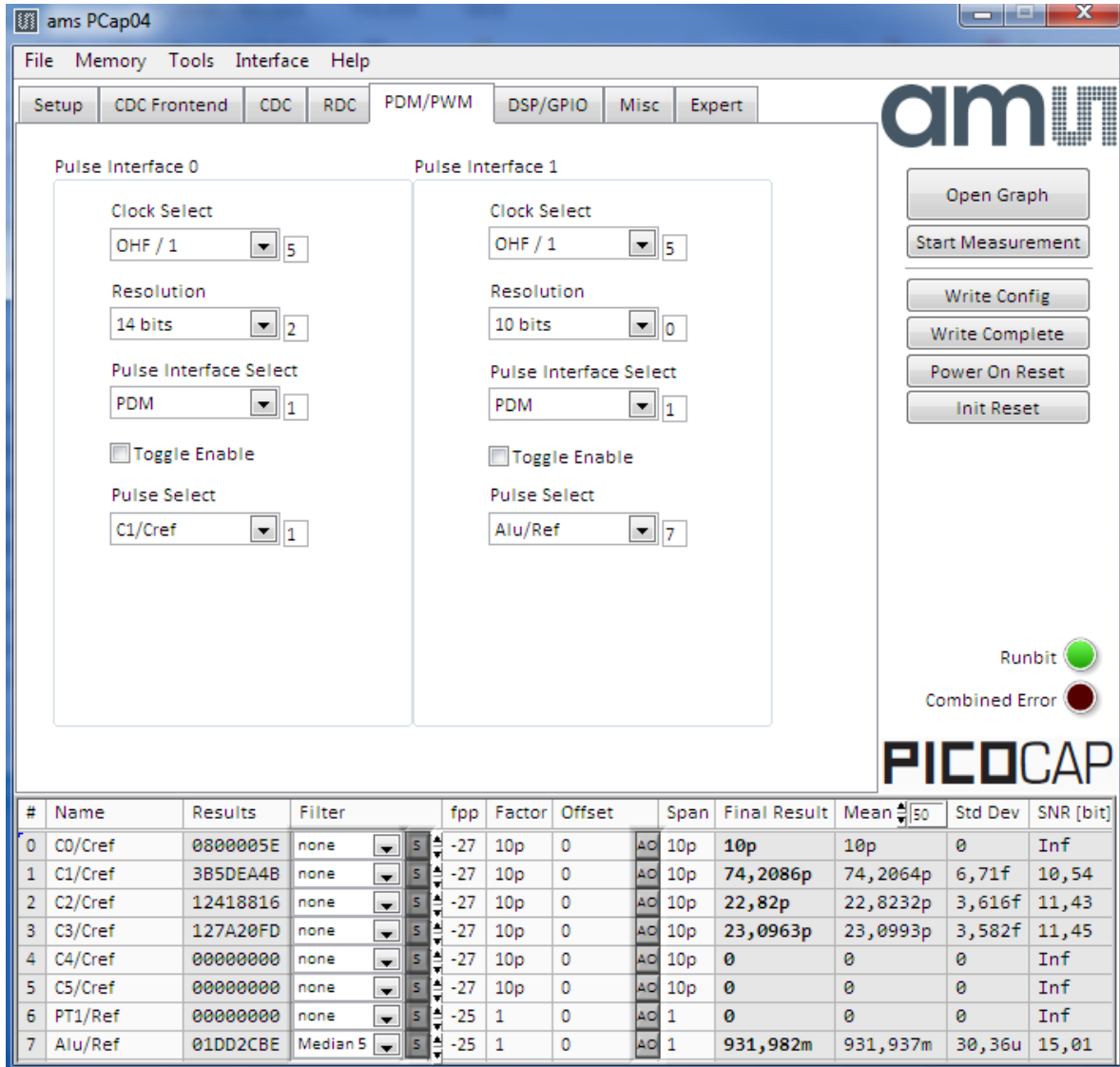

Figure 15 PDM/PWM page

Options on 'PDM / PWM' Page:

Clock Select	Selects the clock frequency to be used for the PWM/PDM generation.
Resolution	Resolution of the output in bits. This resolution also determines the pulsed output range.
Pulse Interface Select	Select the pulse interface – Pulse Width Modulated Output (PWM) or Pulse Density Modulated (PDM) Output. Of the two, the PDM is the recommended interface. With PWM option, 100 kHz clock and 10-bit resolution the resulting PWM output frequency = (100 kHz / 1024) ~ 100 Hz.

Toggle Enable	activates toggle flip flop at Pulse Interface Output, especially for PDM to create 1:1 duty factor
Pulse Select	Select the measurement result which has to be given out as pulsed output – any of the capacitance or temperature measurement results.

4.2.1.6 DSP/GPIO Page

#	Name	Results	Filter	fpp	Factor	Offset	Span	Final Result	Mean	Std Dev	SNR [bit]	
0	C0/Cref	0800005E	none	s	-27	10p	0	Ac 10p	10p	0	Inf	
1	C1/Cref	3B5DEA4B	none	s	-27	10p	0	Ac 10p	74,2086p	6,71f	10,54	
2	C2/Cref	12418816	none	s	-27	10p	0	Ac 10p	22,82p	22,8232p	3,616f	11,43
3	C3/Cref	127A20FD	none	s	-27	10p	0	Ac 10p	23,0963p	23,0993p	3,582f	11,45
4	C4/Cref	00000000	none	s	-27	10p	0	Ac 10p	0	0	Inf	
5	C5/Cref	00000000	none	s	-27	10p	0	Ac 10p	0	0	Inf	
6	PT1/Ref	00000000	none	s	-25	1	0	Ac 1	0	0	Inf	
7	Alu/Ref	01DD2CBE	Median 5	s	-25	1	0	Ac 1	931,982m	931,937m	30,36u	15,01

Figure 16 DSP/GPIO page

Options on 'DSP/GPIO' Page:

DSP

DSP_SPEED	Select the DSP Speed. Choose between Fastest, Fast, Slow and Slowest.
DSP_FF_IN	Pin mask for latching flip-flop activation (PG0 to PG3)
DSP_MOFLO_EN	Activates anti-bouncing filter in PG0 and PG1 lines
DSP_STARTONPIN	Not supported by standard firmware The DSP can be started externally by a signal on a pin; these buttons select the pin that has to be sensed for detecting the start signal.
DSP_START_EN	Mask for activating various trigger sources for starting the DSP

GPIO

PG_DIR_IN	To configure the ports PG0-PG3 as input (otherwise output)
PG_UP	To enable the internal pull up on the ports PG0-PG3
PG0_X_PG2	Possible only when the selected interface for communication is IIC. Interchange PortG0 with PortG2. This is useful when the Pulsed output is needed on Port PG0 instead of PG2.
PG1_X_PG3	Possible only when the selected interface for communication is IIC. Interchange PortG1 with PortG3. This is useful when the Pulsed output is needed on Port PG1 instead of PG3.
PG4_INTN_EN	Map the Interrupt output from chip, INTN to Port PG4. This setting is useful for 24 pin QFN package, because the dedicated INTN pin is absent in this version.
PG5_INTN_EN	Map the Interrupt output from chip, INTN to Port PG5. This setting is useful for 24 pin QFN package, because the dedicated INTN pin is absent in this version.

4.2.1.7 Misc. Page

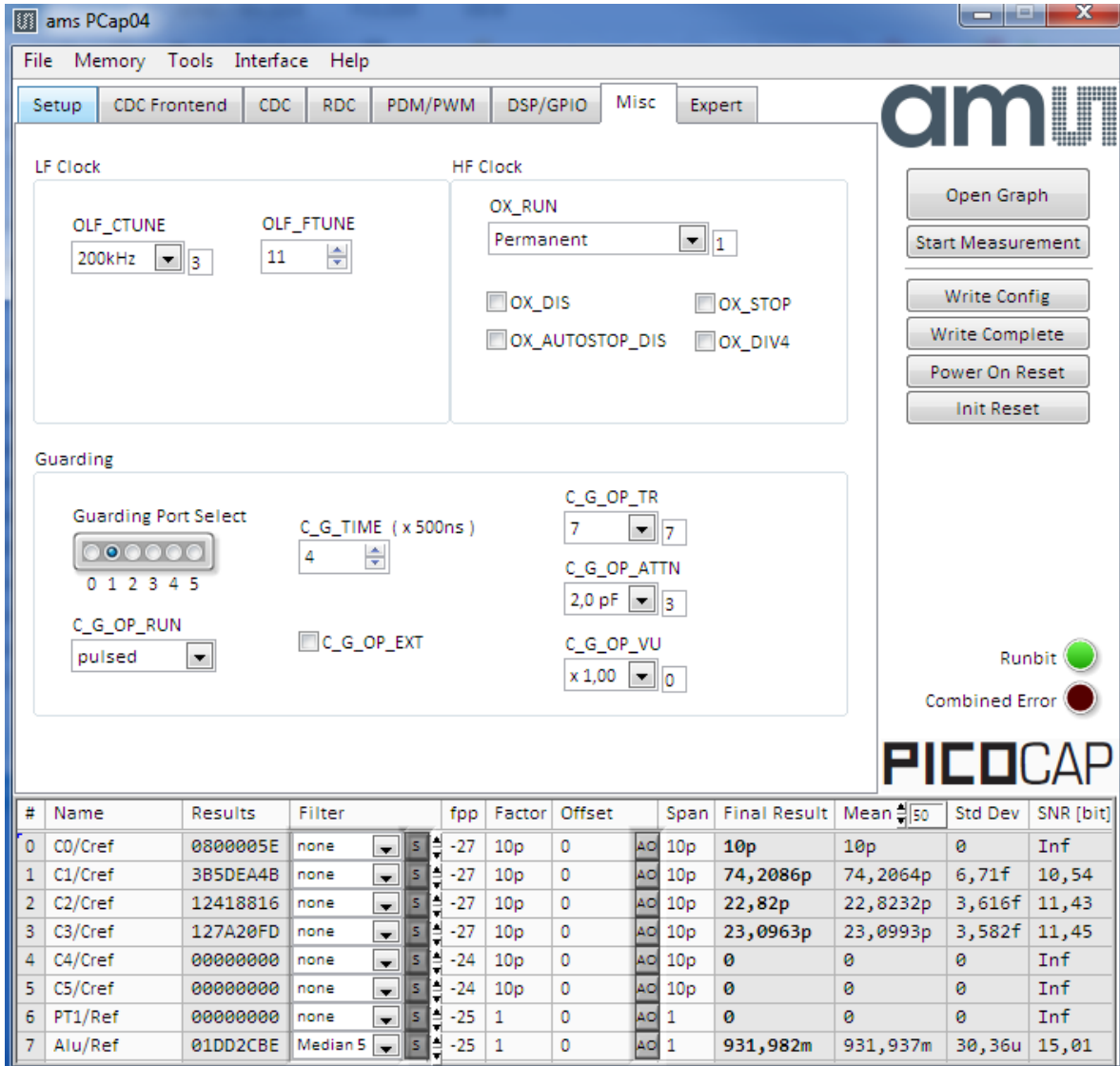

Figure 17 Misc. page

Options on 'Misc.' Page:

Lf Clock

OLF_CTUNE	Coarse-tune the low frequency clock. (10kHz, 50kHz, 100kHz, 200kHz)
OLF_FTUNE	Fine-tune the low frequency clock. (0..15)

Hf Clock

OX_RUN	Controls the permanency or the latency of the OX generator. Latency means an oscillator settling time before a measurement starts.
--------	--

OX_DIS	Disable the OX clock.
OX_AUTOSTOP_DIS	Disables the automatic stop function of the OX generator between the individual measure sequences.
OX_STOP	Stop the OX-generator
OX_DIV4	OX clock frequency := raw freq./4

Guarding

Guarding Port Select	Individual Guard enable to each Port PC0..PC5
C_G_OP_RUN	permanent – Guarding OP is permanent activated (additional power consumption) pulsed – Guarding OP set to sleep mode between CDC conversions
C_G_TIME	Controls the pre-charge phase
C_G_OP_EXT	Switch between internal guarding OP and an optional external OP
C_G_OP_TR	Trim power consumption of guarding OP.
C_G_OP_ATTN	Capacitive attenuation of Guarding OP.
C_G_OP_VU	OP Gain (from Sense Port to Guard).

4.2.1.8 Expert Page

Please modify the settings on the Expert page only in consultation with acam Support team.

4.2.2 Front Panel Menus

4.2.2.1 File Menu

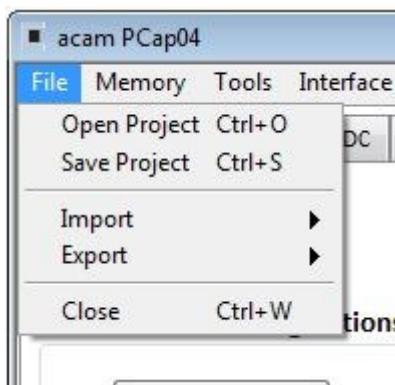

Figure 18 File Menu

Open Project	Open project file *.prj that subsumed the firmware and configuration filenames and the settings and Calibration data
Save Project	Here you can save your own project file.
Import	Import configuration (*.cfg), calibration data (*.dat) or firmware. Note: Any import will modify the active project file! Save the project file under a new name.
Export	Here you can export Config (*.cfg), Calibration (*.dat), Memory (*.dat) or Firmware (*.hex), separately
Close	Close the evaluation software

4.2.2.2 Memory Menu

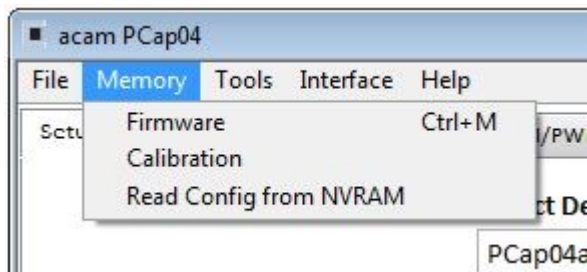

Figure 19 Memory Menu

Figure 1-10: Memory Menu

Firmware	Opens the window to download the firmware. (section 4.2.3.1)
Calibration	Opens the Calibration window (section 4.2.3.2)
Read Config from NVRAM	Reads back the configuration information from the NVRAM and overwrites those of the GUI.

4.2.2.3 Tools Menu

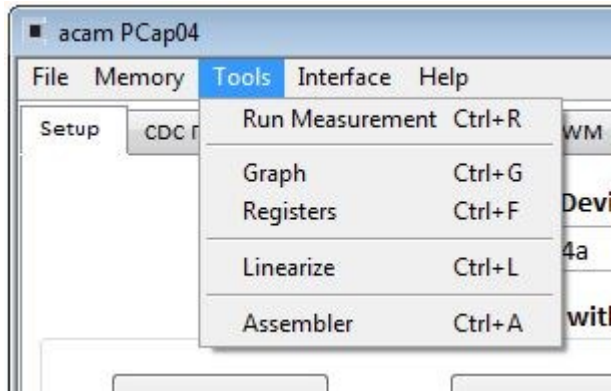

Figure 20 Tools Menu

Run Measurement	Start the measurement
Graph	Opens the window for graphical display of the various measurement results (section 4.2.3.4)
Registers	Opens the Register window (section 4.2.3.5)
Linearize	Opens the Linearize window
Assembler	Opens the assembler

4.2.2.4 Interface Menu

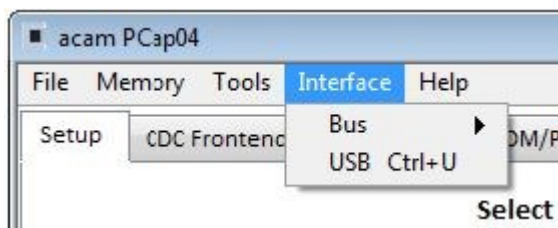

Figure 21 Interface Menu

Bus	Select between SPI and I2C interface
USB	Opens the USB Communications window with PicoProg V3.0 Settings and the possibility to send opcodes

4.2.2.5 Help Menu

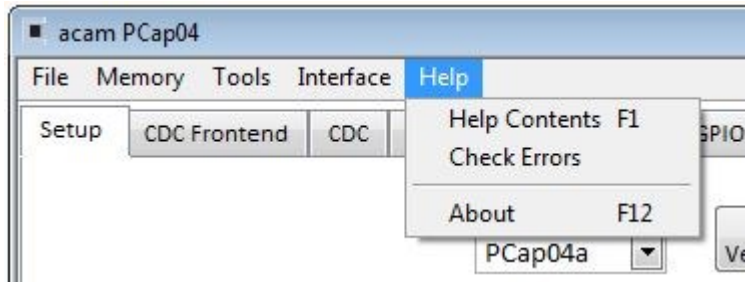

Figure 22 Help Menu

Help Contents	Opens the help window
Check Errors	Opens the error message window if there is an inconsistency after plausibility check.
About	Version

After each change in settings, the evaluation software automatically performs a plausibility check in the background. If a setting is not allowed or doesn't fit with the setting of the other parameters, the faulty setting is highlighted in red color.

4.2.3 Special Windows

4.2.3.1 Firmware Window

In the 'Firmware' Window the write data can be edited.

If the NVRAM is read ('Read' button), the content is automatically compared with the 'Write Data' window content. If contents are equal this will be indicated by a green illuminated LED.

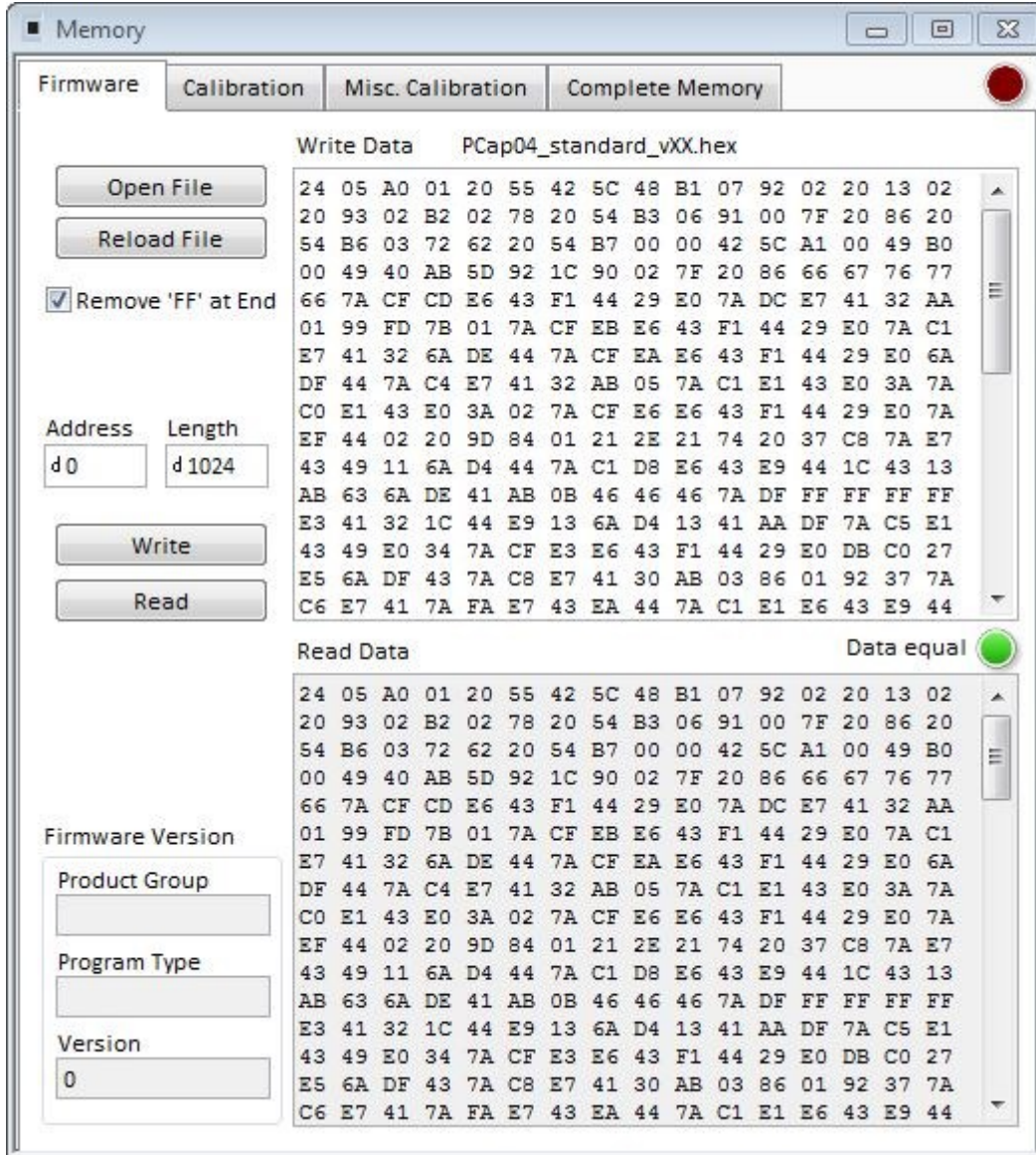

Figure 23 Firmware Window

Open File	Select and open a firmware file (.hex) or import firmware from a project file. The content is shown in the 'Write Data' window.
Reload File	Reload the last opened firmware file (.hex). The content is shown in the 'Write Date' window again.
Read	Pressing this button, the content of the NVRAM is read and shown in the 'Read Data' window. In 'Address' and 'Length' you can specify how many bytes you want read, starting at which address.
Write	Writes the firmware into the chip's NVRAM. The status of the write process is indicated by the green bar. The successful end is indicated by a pop-up window. For verification we recommend to read back the NVRAM afterwards and compare it with the source.
Firmware Version	In the firmware, a specific address is reserved to save 3 byte information about the application and the version of the software. The coding is specified in the header file of the supported PICOCAP device, for example: <i>pcap_standard.h</i> . The header file is found in the library directory of the assembler.

4.2.3.2 Calibration Window

The NVRAM provides the possibility to store data like linearization coefficients, division steps, alert levels etc.. This way, one and the same firmware can be used for various types of sensors.

The Calibration data are part of the project file. After opening a project, the Calibration data need to be written manually. Therefore please open the “Memory / Calibration” menu and then press “Write” or use the ‘Write Complete’ button.

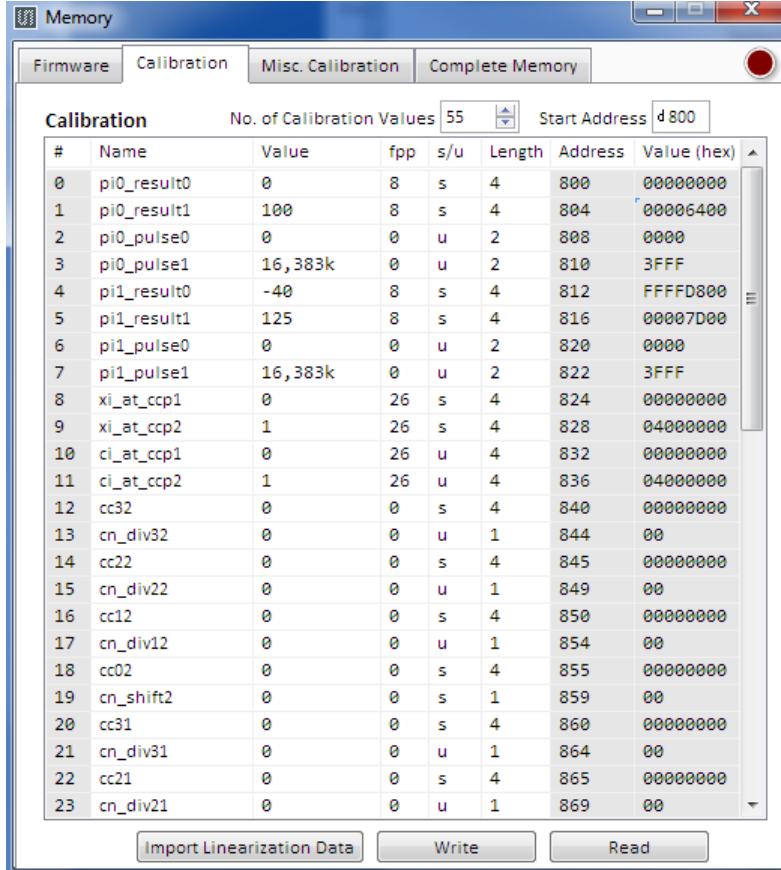

Figure 24 Calibration Window

Import Linearization Data	Imports Linearization Data from “Linearize / Pulse” window
Write	Writes the data into the chip’s NVRAM.
Read	Pressing this button, the Linearization Data are read from the NVRAM and shown in the tab.

4.2.3.3 Misc. Calibration Window

This window shows miscellaneous calibration bits at address d'956-d'959 (4 byte). The meaning of the content strongly depends on the firmware.

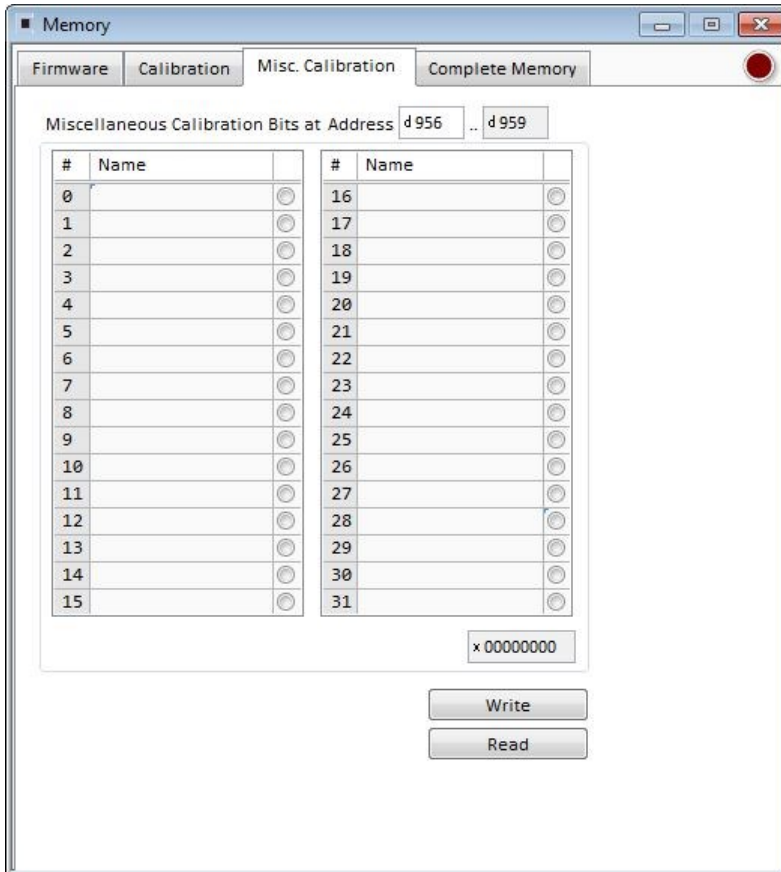

Figure 25 Misc. Calibration Window

Write	Writes the data into the chip's NVRAM.
Read	Pressing this button, the bits are read from the NVRAM and shown in the tab.

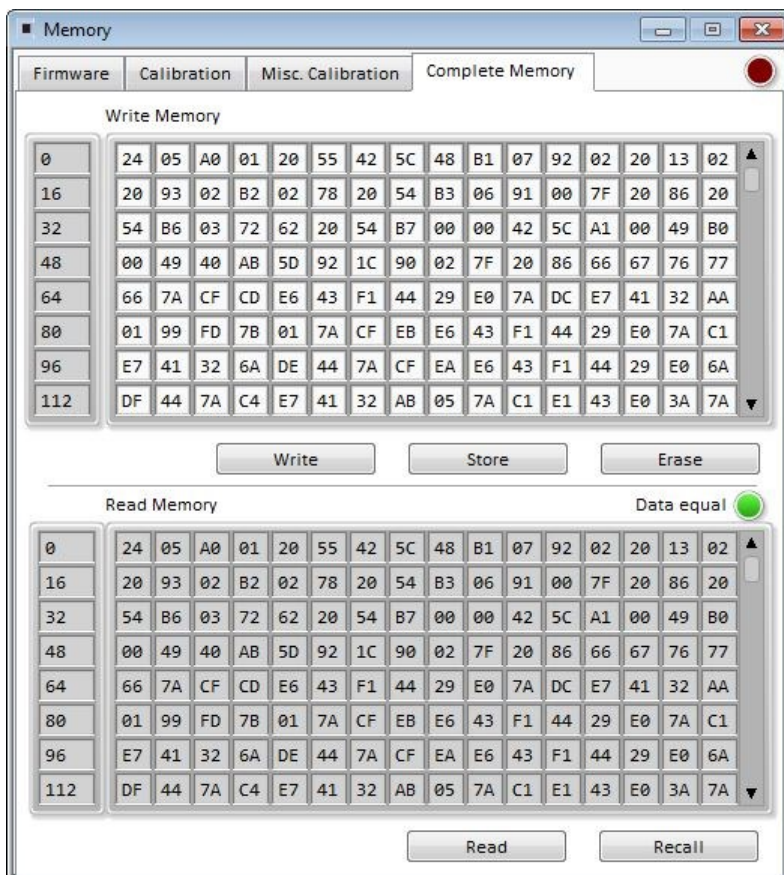

Figure 26 Complete Memory Window

Write	Writes the complete NVRAM.
Store	The complete data transfer from Memory (volatile) to FLASH (non-volatile) is performed by a STORE
Erase	During this ERASE procedure, first the complete NVRAM will be erased (set to zero) and afterwards the MEM_LOCK bits will be cleared.
Read	Pressing this button, the complete NVRAM are read and shown in the tab.
Recall	This means that the complete Memory is copied from the FLASH (non-volatile) to the Memory (volatile). After a power-on reset, a recall is processed.

4.2.3.4 Graph Window

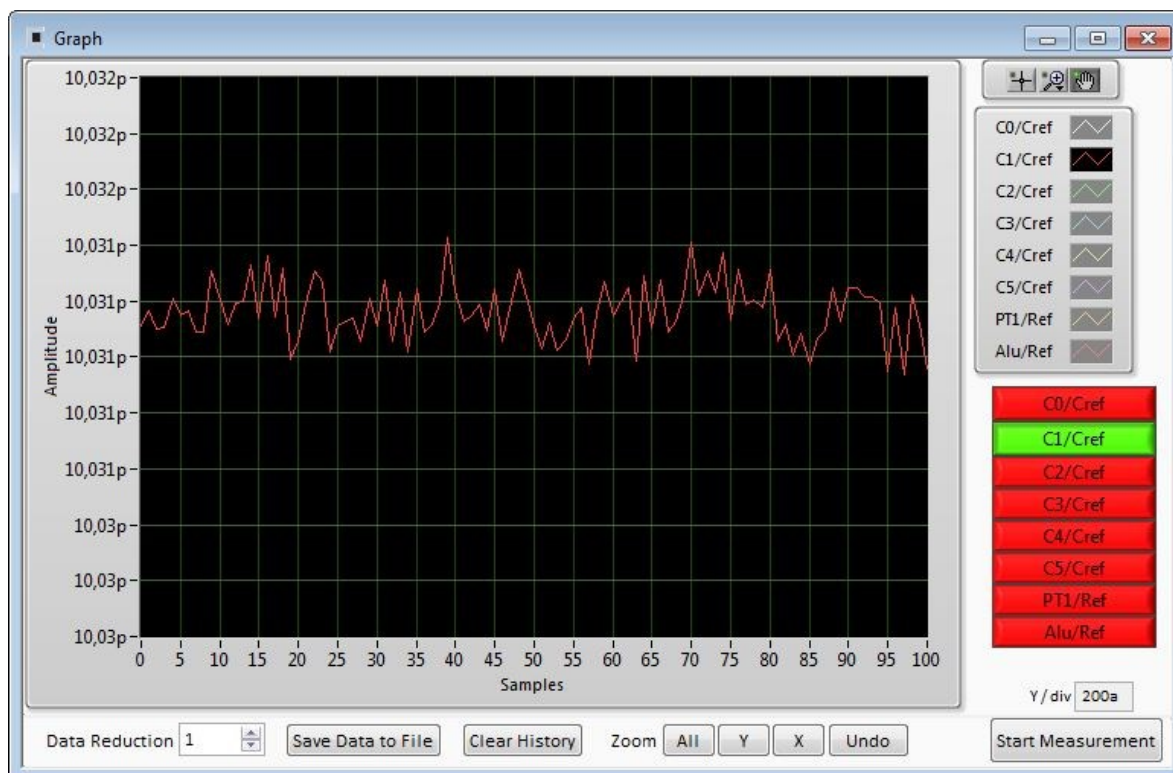

Figure 27 Graph Window

The data to be displayed are selected in the field at the bottom right. The labels in the buttons are the same as in the diagnostics window. To display data press the corresponding button so that it gets green. Top right of the 'Graph' Windows are various options for automatic zoom in/out, center or scale in other ways. Below the graph are various automatic zoom functions for the x-axis and the y-axis.

Y-Zoom will be changed with the keys [+], [-] and X-Zoom with the keys [*], [/]. With the cursor control keys [←], [→], [↑], [↓] it is possible to move the graph.

The data displayed can be stored into a text file. For long-term investigations it is possible to reduce the data displayed and stored. The field 'Data Reduction' allows to define the level of data reduction.

4.2.3.5 Registers Window

These windows display the configuration data in hexadecimal format as they are currently used. Also the result registers' content is shown in hexadecimal format, but updated only when the button is pressed. Finally, the various status bits are shown.

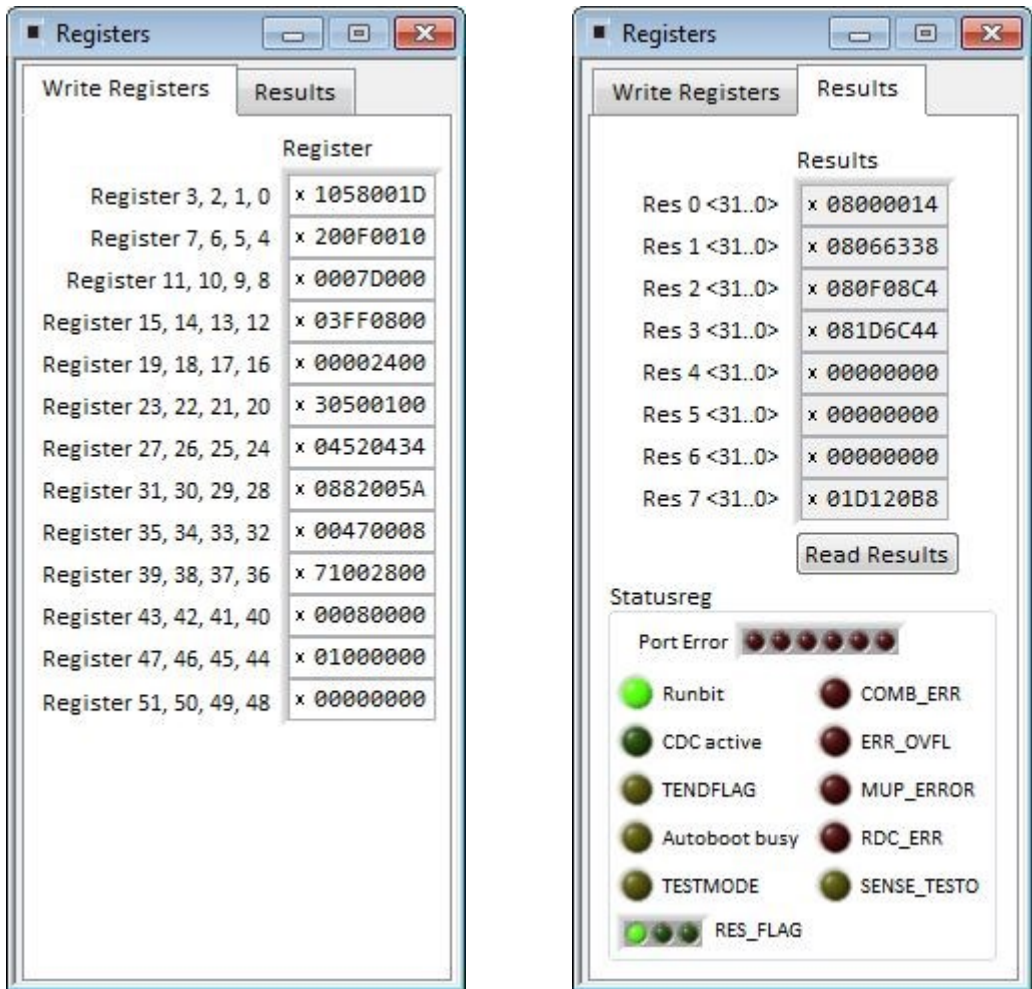

Figure 28 Write Registers and Results

4.2.4 Linearize

4.2.4.1 Sensor Characterization

The first step is the characterization of the sensor. Therefore, it is necessary to collect data at several measurement points and at several temperatures.

As mentioned earlier, the data collection should be made of minimum 12 measurements, taken at least at 3 different temperatures. The temperatures should cover the operating temperature range of interest of the final device. The number of calibration points is set at the top left. This is the first thing to be done. Then calibration can begin. Line by line the user can enter the reference values for Z and ϑ at the various calibration points. Having the cursor in this line it is sufficient to press the acquire button to get the actual c_i ratio result. But of course the value can be entered manually, too.

The graph on the bottom left shows the Z, ϑ distribution of the calibration points. Ideally it should have dots on three different lines covering the operating range of the sensor.

The table on the left shows the calculated calibration coefficients and the graph below shows the deviation due to the mathematical approximation.

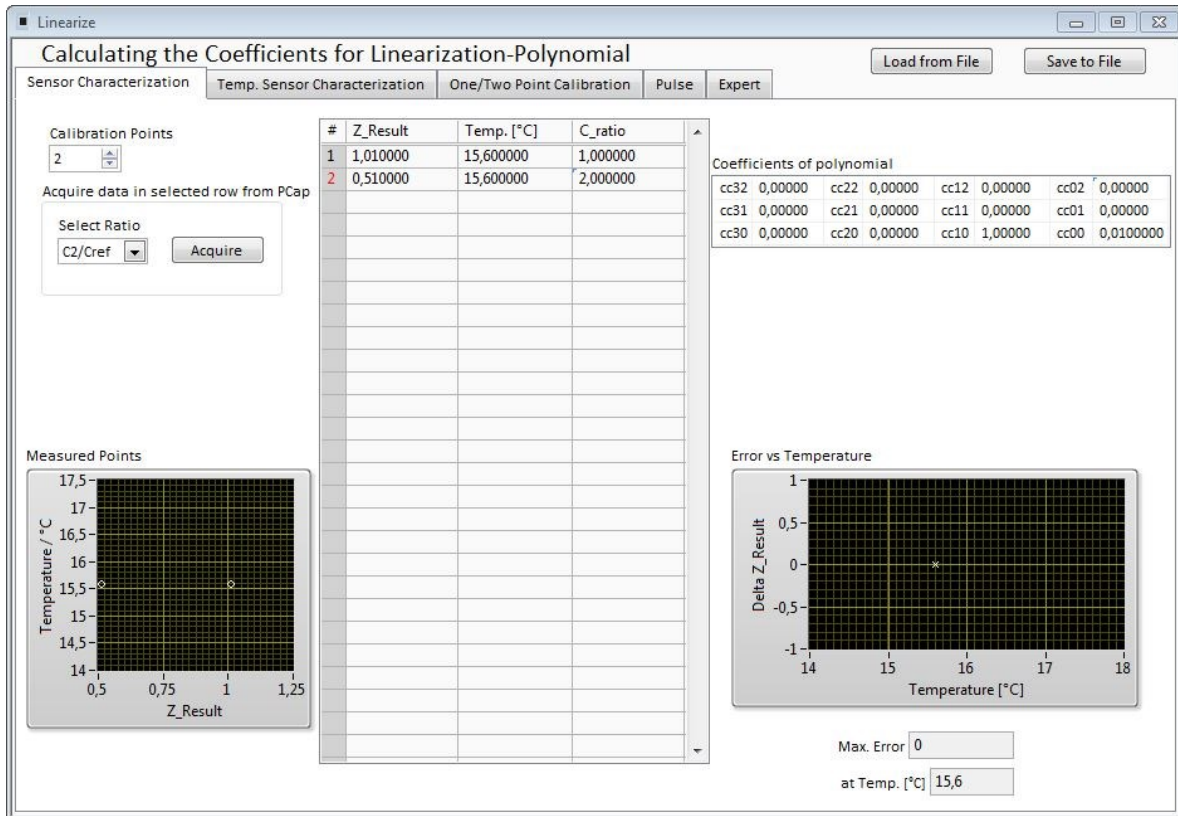

Figure 29 Sensor Characterization

4.2.4.2 Temperature Sensor Characterization

Together with the calibration of the capacitance sensor it is mandatory to calibrate the temperature, too. Whether the internal aluminum sensor is used or an external platinum sensor or any other sensor: they need to be calibrated to get the correct temperature information which is then used as input for the polynomial correction of the capacitance measurement.

The tab „Temperature Sensor Characterization” (Figure 1-18) offers a tool very similar to the capacitive sensor characterization. The resistance ratio has to be collected at several temperature points. For best approximation 4 calibration points are needed. In case of 2 or 3 calibration points a 2nd respectively a 3rd order polynomial is calculated.

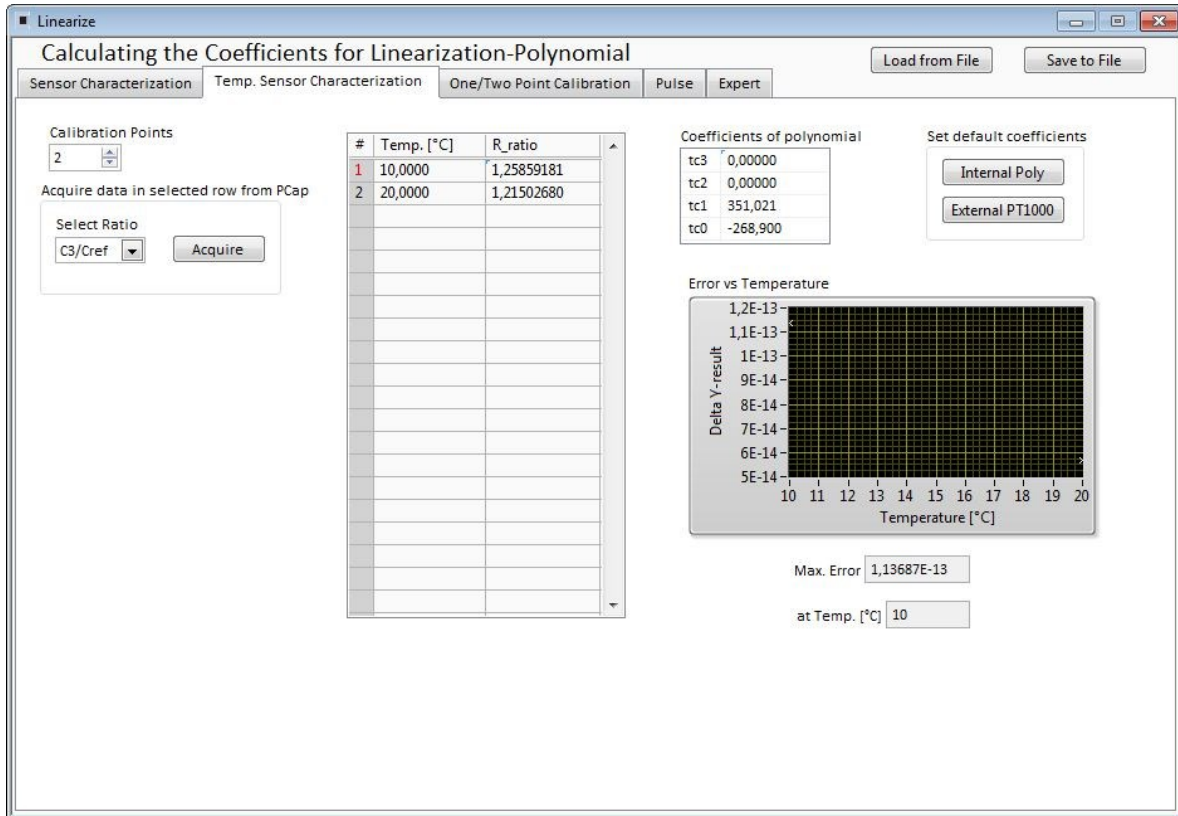

Figure 30 Temp. Sensor Characterization

On the right side of the tab “Temperature Sensor Characterization” there are two buttons to select default characteristic data for the internal aluminum sensor and a platinum sensor. The aluminum is assumed to be linear in a range of 10 °C to 70°C so only two coefficients are used.

In case the default values are used it is necessary to have at least a two point calibration of the temperature (see next section).

4.2.4.3 One/Two Point Calibration

Once a batch is characterized with respect to the capacitive sensor and the resistive temperature sensor it might be sufficient to perform two-point or even one-point calibration for the rest of the sensors in the batch.

The tab “One/Two Point Calibration” offers a simple GUI to do that. On this page the user enters the reference values for Z and ϑ . CCP1 stands for capacitance calibration point 1 etc.. When the calibration conditions are reached pressing the acquire buttons will read the actual ratios while the theoretical ones are calculated on basis of the linearization coefficients. Together with programmable limits for minimum and maximum this gives an additional set of 12 parameters to be written into the EEPROM.

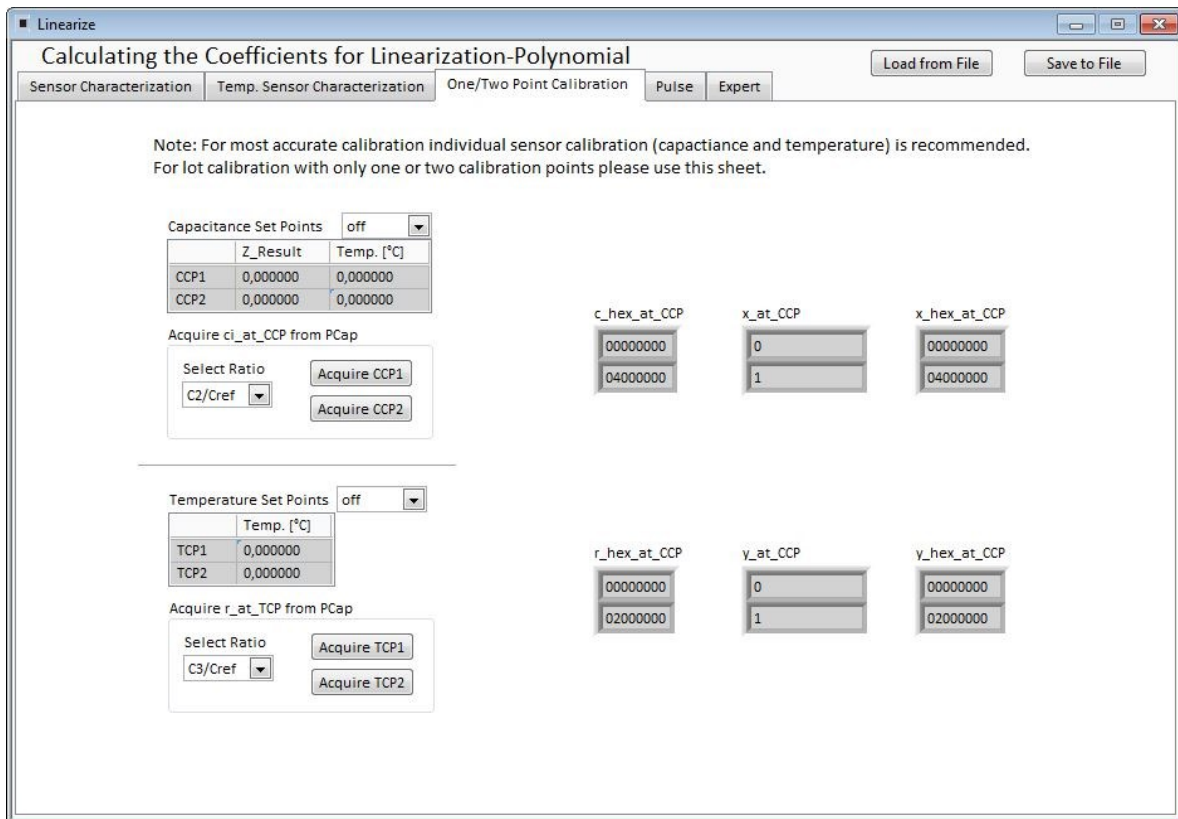

Figure 31 One/Two Point Calibration

4.2.4.4 Pulse

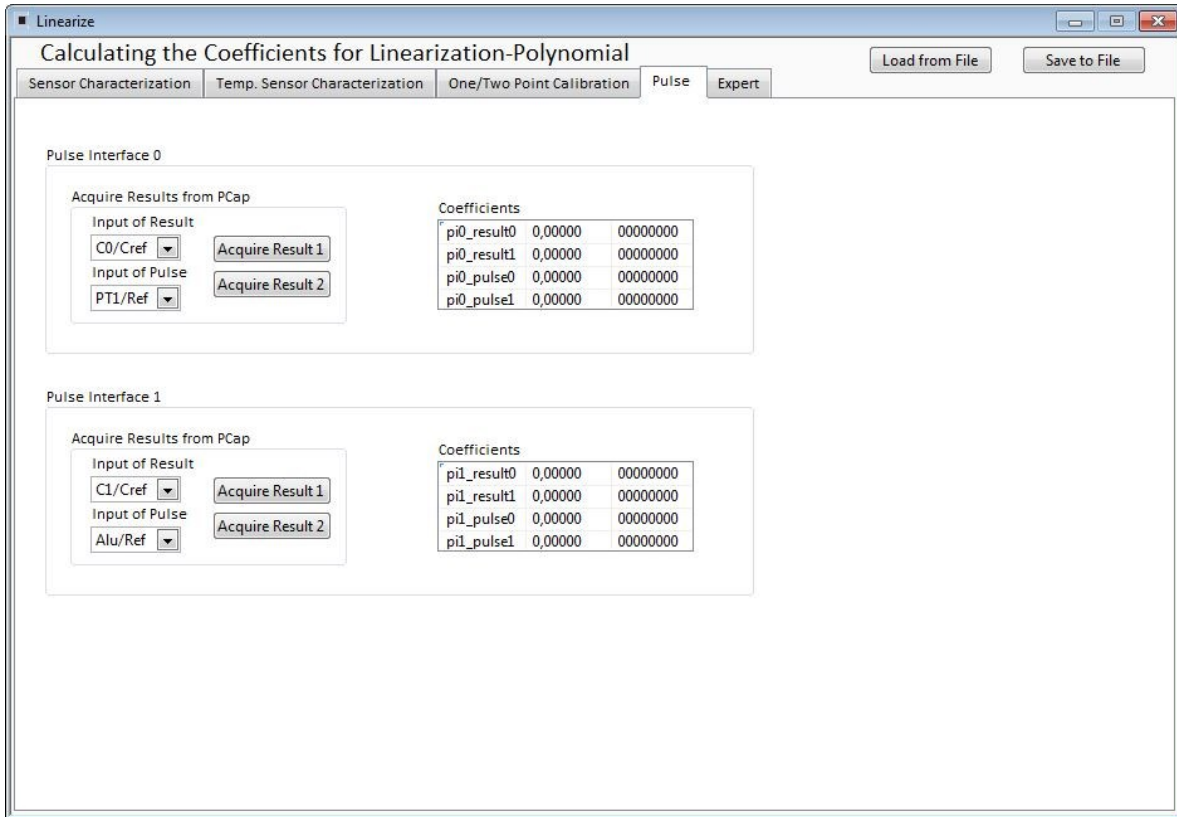

Figure 32 Pulse

4.2.4.5 Expert

As indicated by the name this tab is for experts only. There you set the fixed point position of the result Z. It further displays the numbers of division steps respectively shift operation to achieve the maximum resolution over all calculations.

Those are stored in the NVRAM, too. But they are calculated by the DLL and for information purpose only.

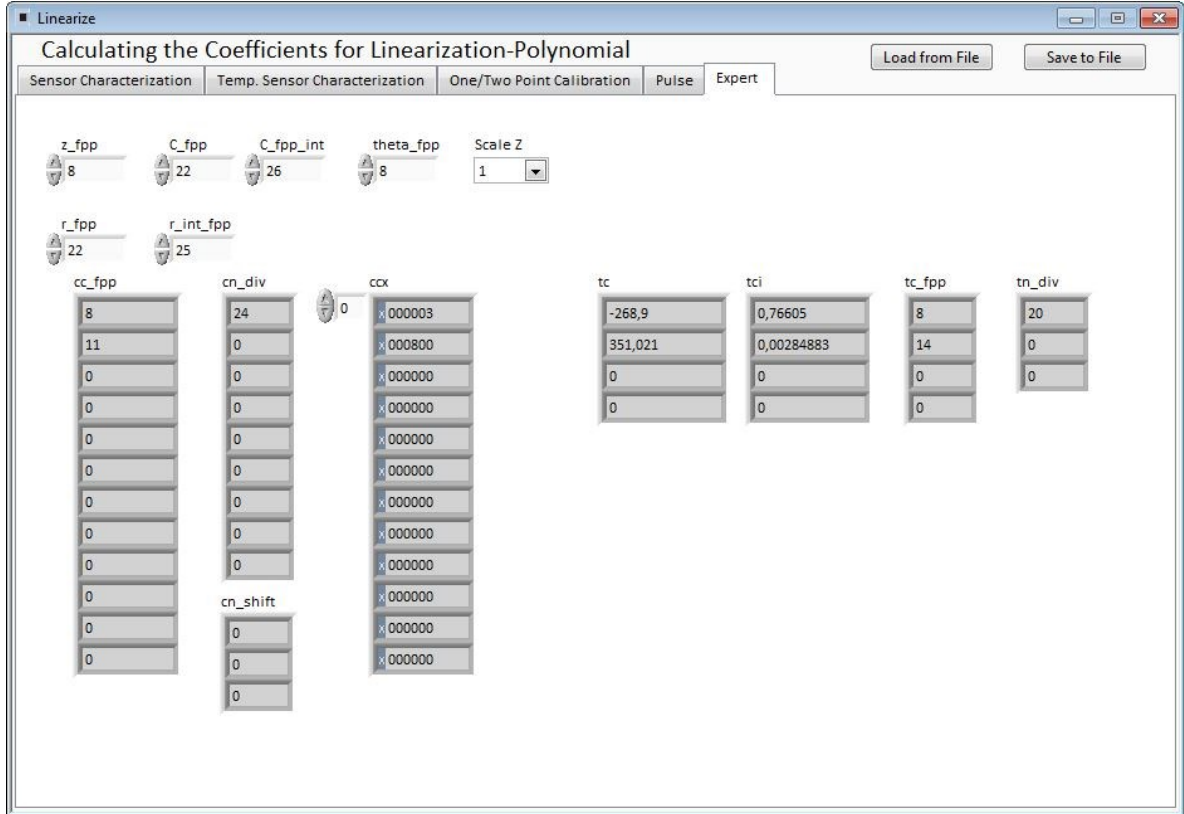

Figure 33 Expert

4.2.5 Assembler

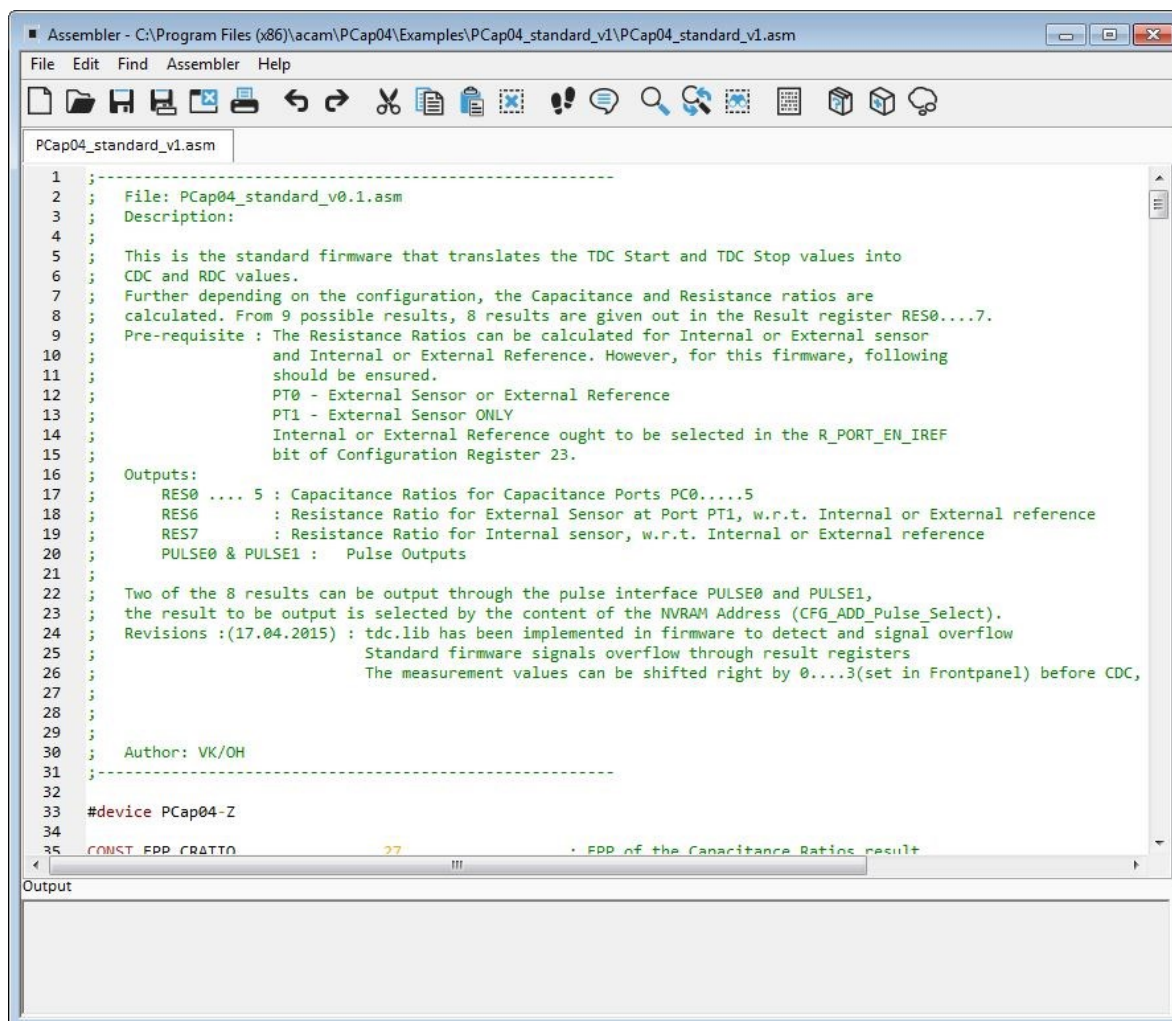

Figure 34 Assembler

This is a comfortable editor with syntax highlighting, search and replace, copy and paste functions.

Under menu item “Assembler” the user finds the compile and download options.

Whether the call of these functions was successful or not is indicated by the messages at the bottom of the assembler window.

Debugging is not supported in this software revision.

4.3 Scaling Results

PCap04 in general calculates capacitance ratios. The measured ratios include of course all effects from parasitic capacitances. Nonetheless, in many cases users might be interested in an intuitive understanding the displayed values without making a full calibration run.

The following shows by example how to set Factor and Offset to give a suitable display.

Starting point: 10 pF between PC0 and PC1, 12.2 pF between PC2 and PC3, 8pF between PC4 and PC5.

In grounded configuration, the chip measures 10pF reference against 10 pF at PC1, 12.2 pF at PC2 and PC3 and 8 pF at PC4 and PC5. In floating configuration 10pF reference is measured against 12.2 pF and 8pF.

a. Grounded single, no compensation

The capacitance seen includes the port parasitic capacitance as well as the internal “parasitic” capacitance (5 to 6 pF), which is dominated by the comparator delay (about 10 pF).

The base capacitance is then not 10 pF but 25 pF. Thereof 15 pF are Offset which can be subtracted.

#	Name	Results	Filter	fpp	Factor	Offset	Span	Final Result	Mean	Std Dev	SNR [bit]
0	C0/Cref	08000013	none	-27	25p	-15p	AO 10p	10p	10p	0	Inf
1	C1/Cref	0808B6B7	none	-27	25p	-15p	AO 10p	10,1064p	10,1063p	234,5a	15,38
2	C2/Cref	08BF5F56	none	-27	25p	-15p	AO 10p	12,3361p	12,336p	225,2a	15,44
3	C3/Cref	08BA5E49	none	-27	25p	-15p	AO 10p	12,275p	12,2748p	316,8a	14,95
4	C4/Cref	075FA4B4	none	-27	25p	-15p	AO 10p	8,04252p	8,04221p	291,4a	15,07
5	C5/Cref	07688199	none	-27	25p	-15p	AO 10p	8,15071p	8,15064p	257,6a	15,24

b. Floating single, no compensation

The influence of parasitic capacitances is the same and therefore the setting for Factor and Offset are the same.

#	Name	Results	Filter	fpp	Factor	Offset	Span	Final Result	Mean	Std Dev	SNR [bit]
0	C0/Cref	08000009	none	-27	25p	-15p	AO 10p	10p	10p	0	Inf
1	C1/Cref	08B81EAB	none	-27	25p	-15p	AO 10p	12,2476p	12,2474p	273,1a	15,16
2	C2/Cref	076008D8	none	-27	25p	-15p	AO 10p	8,0473p	8,04729p	167,9a	15,86

c. Ground single, internal compensation

Now the chip sees only the port parasitic capacitance, not the internal one. This is in the order of 5 to 6 pF. Accordingly, the total base capacitance is 15 pF (Factor) with an offset of 5 pF.

#	Name	Results	Filter	fpp	Factor	Offset	Span	Final Result	Mean	Std Dev	SNR [bit]
0	C0/Cref	08000021	none	-27	15p	-5p	AO 10p	10p	10p	0	Inf
1	C1/Cref	080E6BCE	none	-27	15p	-5p	AO 10p	10,1056p	10,1059p	219,2a	15,48
2	C2/Cref	0946D492	none	-27	15p	-5p	AO 10p	12,3938p	12,3935p	283a	15,11
3	C3/Cref	093E1B82	none	-27	15p	-5p	AO 10p	12,3299p	12,3295p	353,1a	14,79
4	C4/Cref	06ECA6E1	none	-27	15p	-5p	AO 10p	7,98329p	7,98315p	274,7a	15,15
5	C5/Cref	06FBDDE2	none	-27	15p	-5p	AO 10p	8,09473p	8,09469p	214,2a	15,51

d. Floating single, internal compensation

Again, the chip sees only the port parasitic capacitance. But due to the different port pattern the correction factors are slightly higher.

#	Name	Results	Filter	fpp	Factor	Offset	Span	Final Result	Mean	Std Dev	SNR [bit]
0	C0/Cref	0800000C	none	-27	20p	-10p	AO 10p	10p	10p	1,632E-	52,44
1	C1/Cref	08E7E36C	none	-27	20p	-10p	AO 10p	12,2645p	12,2646p	301,6a	15,02
2	C2/Cref	0735B673	none	-27	20p	-10p	AO 10p	8,02454p	8,02458p	252,1a	15,28

Using floating in combination with an internal reference there is a deviation as we have internally only a single grounded capacitor. This is measured twice and the factor needs to be doubled.

e. Floating, both compensation

Now all parasitic capacitances are compensated. The initial base capacitance without offset can be used.

#	Name	Results	Filter	fpp	Factor	Offset	Span	Final Result	Mean	Std Dev	SNR [bit]
0	C0/Cref	0800001A	none	-27	10p	0	AC 10p	10p	10p	0	Inf
1	C1/Cref	09E81FB7	none	-27	10p	0	AC 10p	12,3834p	12,1831p	1,414p	2,822
2	C2/Cref	066773EF	none	-27	10p	0	AC 10p	8,00514p	6,40549p	3,703p	1,433

4.4 Scaling PDM Output

Here we describe how to scale the PDM output when working with the standard firmware. Open the Memory window and select tab calibration:

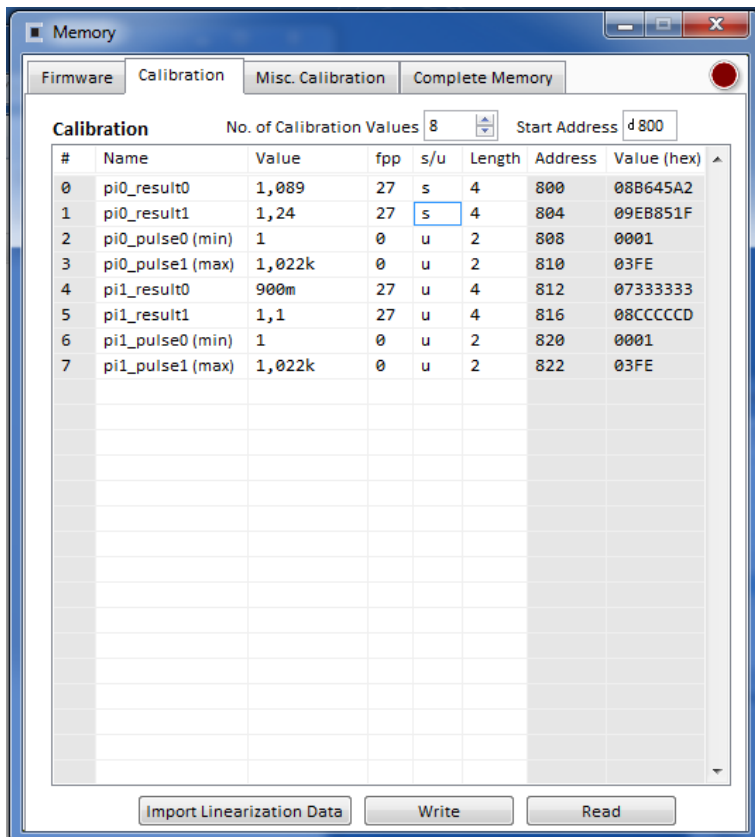

Set fpp to 27 and s/u to S for signed. Enter the capacitance ratios at minimum and maximum sensor signal. Set pi0_pulse1 (max) to the value according to the set resolution of the PDM. This is 1023 at 10 bit and 65535 at 16 bit.

Press “write” to write the data into the chip.

5 Schematics, Layers and BOM

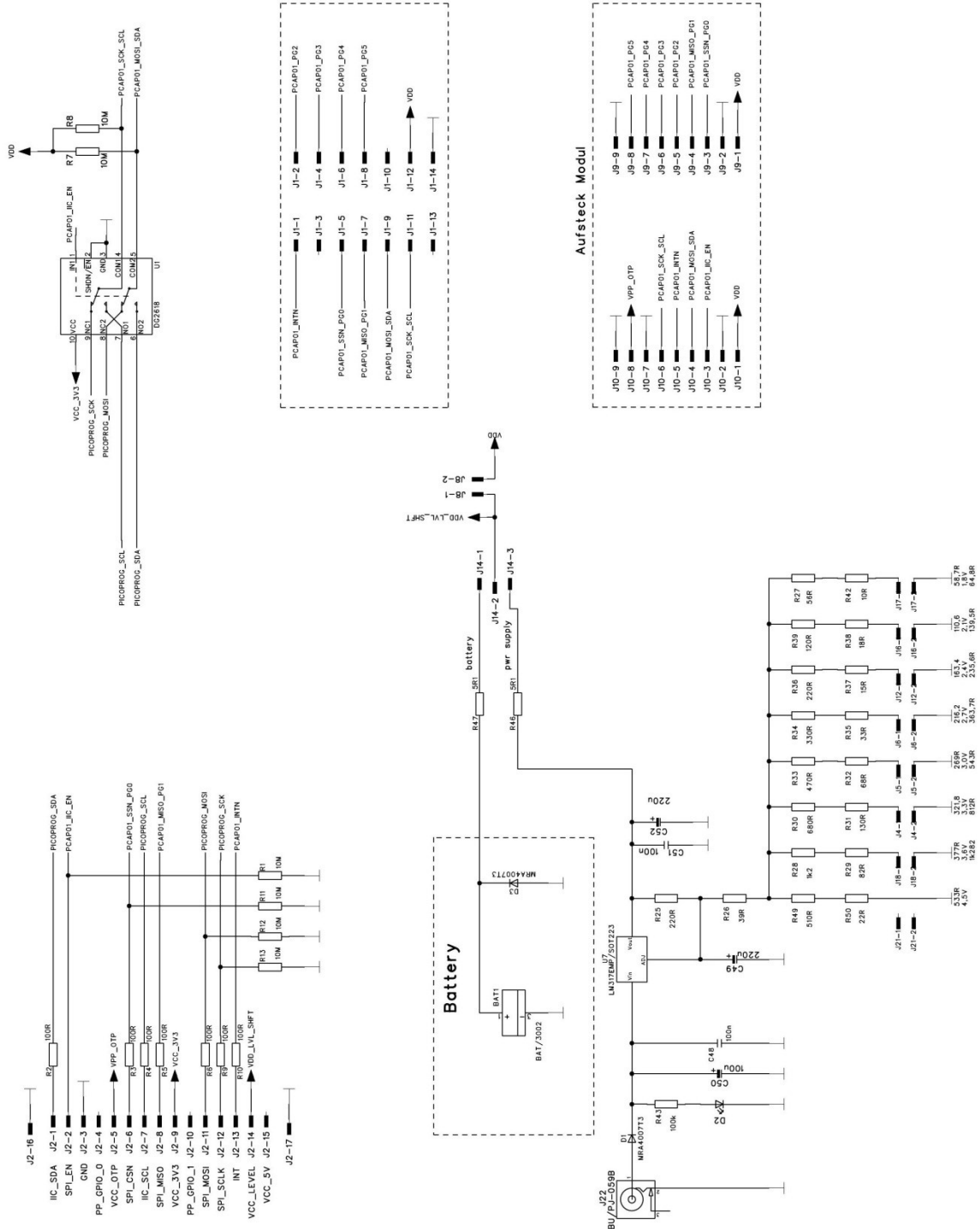

Figure 35: Motherboard schematics

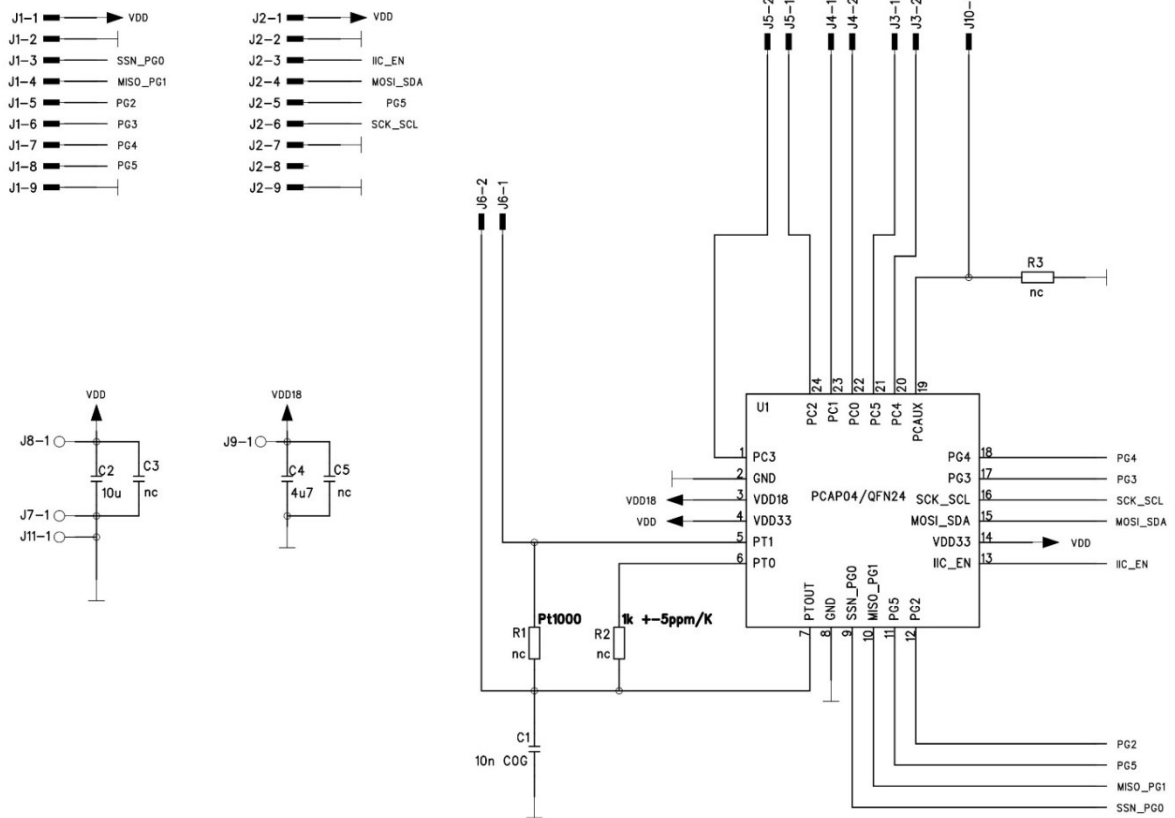

Figure 36: PCa04 AD board schematics

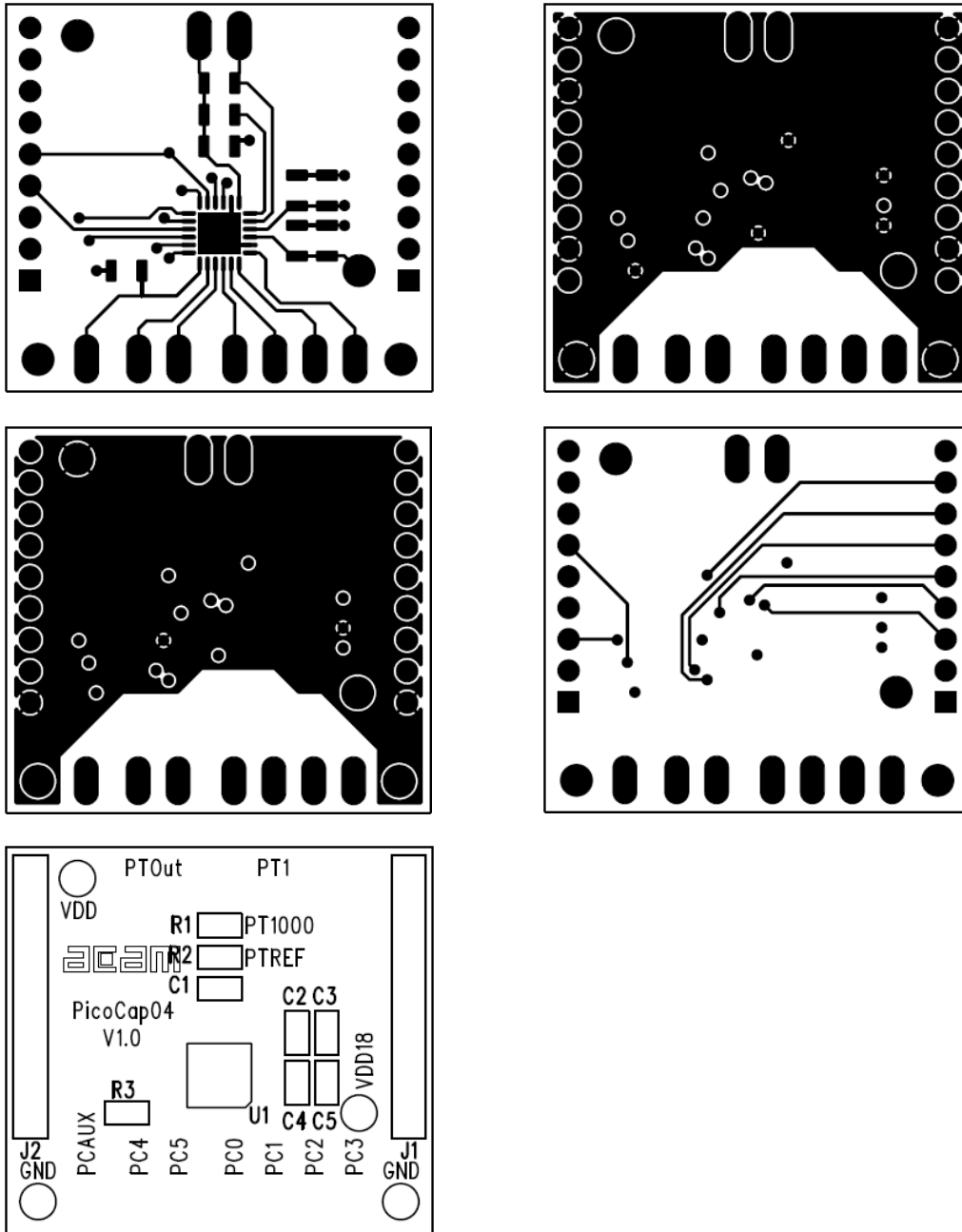

Figure 37: PCa04 AD board layout

Bill of Materials for PCap04 plug-in board

Item	Qty	Reference	Part Name	Description
2	1	C2		C805, 10u
3	1	C4		C805, 4u7
5	1	U1		PCAP04/QFN24
6	3	R1 R2 R3	R805, nc	
4	2	C3 C5	C805, nc	
1	1	C1	C805, nc	CHIP-CAPACITOR

6 Ordering & Contact Information

Ordering Code	Description
PCAP04-EVA-KIT	PCap04 Eval Kit Standard Board
PCAP04-EVA-BOARD	

Buy our products or get free samples online at:

www.ams.com/ICdirect

Technical Support is available at:

www.ams.com/Technical-Support

Provide feedback about this document at:

www.ams.com/Document-Feedback

For further information and requests, e-mail us at:

ams_sales@ams.com

For sales offices, distributors and representatives, please visit:

www.ams.com/contact

Headquarters

ams AG

Tobelbader Strasse 30

8141 Premstaetten

Austria, Europe

Tel: +43 (0) 3136 500 0

Website: www.ams.com

7 Copyrights & Disclaimer

Copyright ams AG, Tobelbader Strasse 30, 8141 Premstaetten, Austria-Europe. Trademarks Registered. All rights reserved. The material herein may not be reproduced, adapted, merged, translated, stored, or used without the prior written consent of the copyright owner.

Demo Kits, Evaluation Kits and Reference Designs are provided to recipient on an “as is” basis for demonstration and evaluation purposes only and are not considered to be finished end-products intended and fit for general consumer use, commercial applications and applications with special requirements such as but not limited to medical equipment or automotive applications. Demo Kits, Evaluation Kits and Reference Designs have not been tested for compliance with electromagnetic compatibility (EMC) standards and directives, unless otherwise specified. Demo Kits, Evaluation Kits and Reference Designs shall be used by qualified personnel only.

ams AG reserves the right to change functionality and price of Demo Kits, Evaluation Kits and Reference Designs at any time and without notice.

Any express or implied warranties, including, but not limited to the implied warranties of merchantability and fitness for a particular purpose are disclaimed. Any claims and demands and any direct, indirect, incidental, special, exemplary or consequential damages arising from the inadequacy of the provided Demo Kits, Evaluation Kits and Reference Designs or incurred losses of any kind (e.g. loss of use, data or profits or business interruption however caused) as a consequence of their use are excluded.

ams AG shall not be liable to recipient or any third party for any damages, including but not limited to personal injury, property damage, loss of profits, loss of use, interruption of business or indirect, special, incidental or consequential damages, of any kind, in connection with or arising out of the furnishing, performance or use of the technical data herein. No obligation or liability to recipient or any third party shall arise or flow out of ams AG rendering of technical or other services.

8 Revision Information

Changes from previous version to current revision 1-02 (2017-Oct-20)	Page
Adding section "4.3 Scaling Results"	42
Adding section "4.4 Scaling PDM Output"	43
Updated screenshots and photos	

Note: Page numbers for the previous version may differ from page numbers in the current revision.
Correction of typographical errors is not explicitly mentioned.