

## Z4DGP406L-HF Thru. Z4DGP410L-HF

Reverse Voltage: 600 to 1000 Volts

Forward Current: 4.0 A

RoHS Device

Halogen free

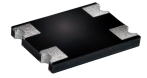

### Features

- Internal structure with GPRC (Glass passivated rectifier chip) inside.
- Lead less chip form, no lead damage.
- Low power loss, High efficiency.
- High current capability.
- Plastic package has Underwriters Laboratory Flammability Classification 94V-0 .

### Mechanical data

- Case: Packed with FRP substrate and epoxy underfilled.
- Terminals: Pure Tin plated (Lead-Free), solderable per MIL-STD-750, method 2026.
- Polarity: Laser marking symbols
- Weight: 0.29 grams (approx).

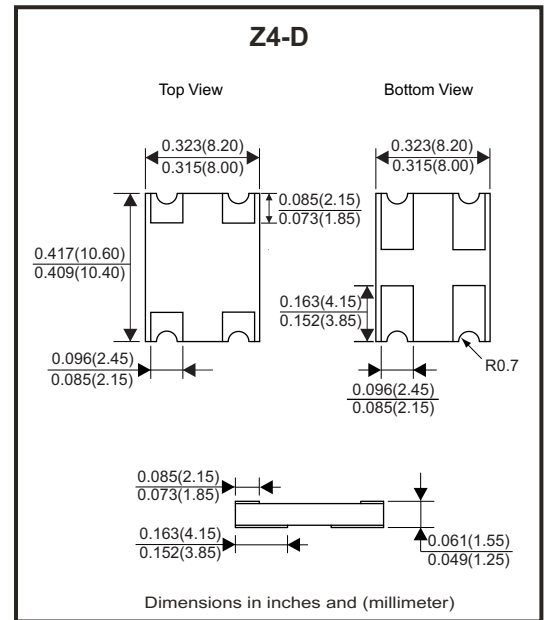

### Circuit Diagram

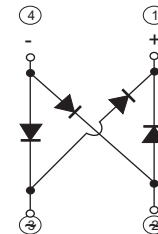

### Absolute Maximum Rating (at TA=25°C unless otherwise noted)

Parameter	Symbol	Z4DGP406L-HF	Z4DGP408L-HF	Z4DGP410L-HF	Unit
Repetitive Peak Reverse Voltage	V <sub>RRM</sub>	600	800	1000	V
Average Forward Current	I <sub>(AV)</sub>	4.0			A
Peak Forward Surge Current, 8.3ms single half sine-wave, superimposed on rated load (JEDEC Method)	I <sub>FSM</sub>	150			A
Operating Temperature Range	T <sub>J</sub>	-55 to +175			°C
Storage Temperature Range	T <sub>STG</sub>	-55 to +175			°C

### Electrical Characteristics (at TA=25°C unless otherwise noted)

Parameter	Symbol	Conditions	Min.	Typ.	Max.	Unit
Forward Voltage	V <sub>F</sub>	IF = 2.0A IF = 4.0A	-	0.86 0.90	0.90 0.95	V
Repetitive peak reverse current	I <sub>RRM</sub>	V <sub>R</sub> =Max. V <sub>RRM</sub> , Ta=25°C	-	0.08	5	uA
Current squared time	I <sup>2</sup> t	t<8.3ms, Ta = 25°C	-	93.38	-	A <sup>2</sup> S
Junction capacitance	C <sub>J</sub>	V <sub>R</sub> =4V, f=1.0MHz	-	45	-	pF
Thermal resistance	R <sub>th(JA)</sub>	Junction to ambient (Note)	-	35	-	°C/W
	R <sub>th(JL)</sub>	Junction to lead (Note)	-	15	-	°C/W

Notes: 1. Thermal resistance, junction to ambient, measured on PC board with 5.0\*5.0mm(0.03mm thick) land areas.

Company reserves the right to improve product design , functions and reliability without notice.

## RATING AND CHARACTERISTIC CURVES (Z4DGP406L-HF Thru. Z4DGP410L-HF)

Fig.1- Forward Current Derating Curve

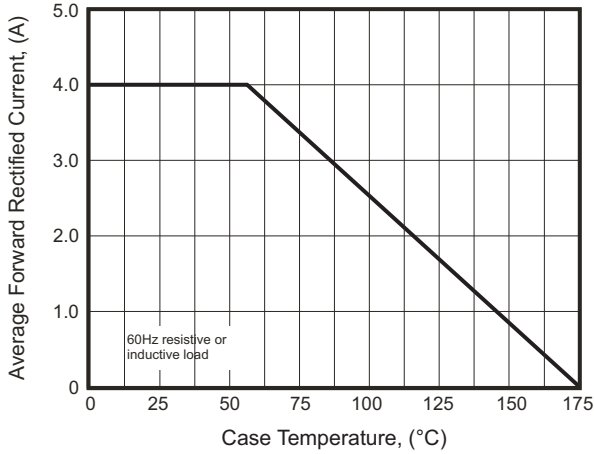

Fig.2- Maximum Non-Repetitive Peak Forward Surge Current

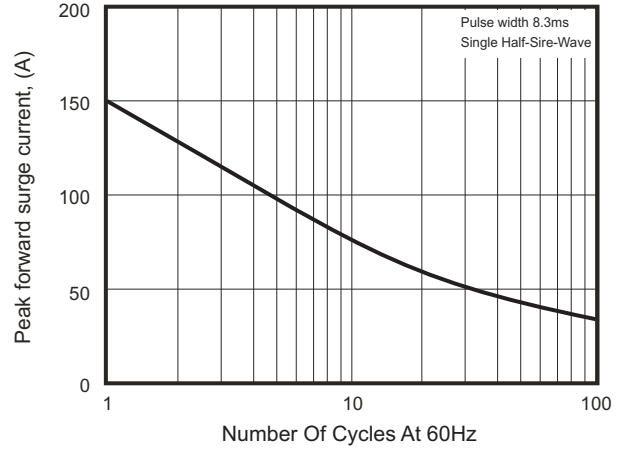

Fig.3- Typical Instantaneous Forward Characteristics

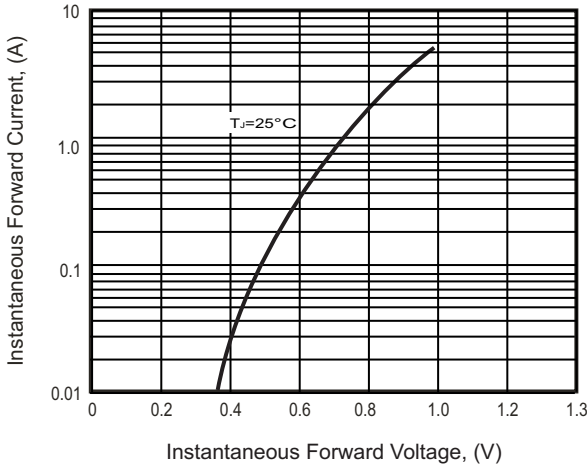

Fig.4- Typical Reverse Characteristics

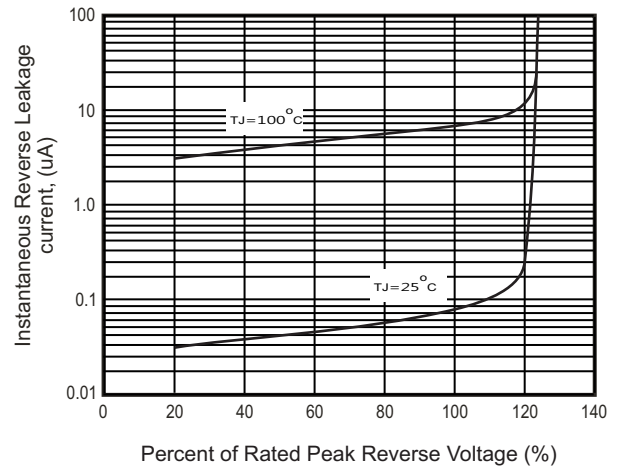
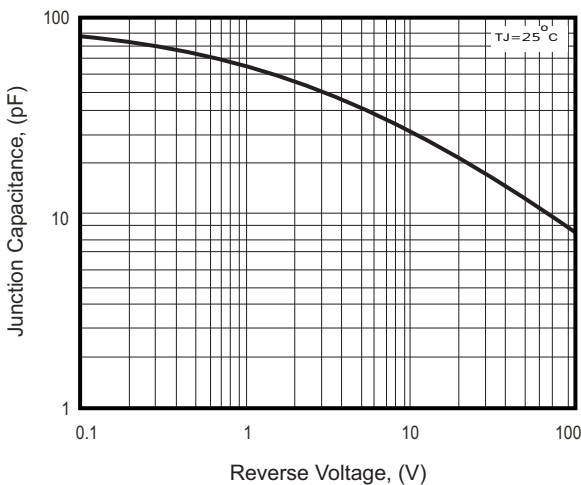
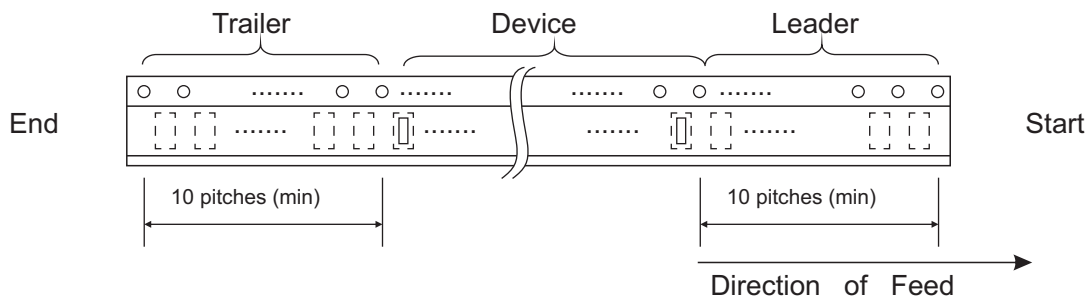

Fig.5 - Typical Junction Capacitance



Company reserves the right to improve product design, functions and reliability without notice.

## Reel Taping Specification



Z4-D	SYMBOL	A	B	C	d	D	D <sub>1</sub>	D <sub>2</sub>
	(mm)	8.25 ± 0.10	10.65 ± 0.10	1.60 ± 0.10	1.55 ± 0.05	330 ± 2.00	50.0 MIN.	13.0 ± 0.50
	(inch)	0.325 ± 0.004	0.419 ± 0.004	0.063 ± 0.004	0.061 ± 0.002	12.992 ± 0.079	1.969 MIN.	0.512 ± 0.020

Z4-D	SYMBOL	E	F	P	P <sub>0</sub>	P <sub>1</sub>	W	W <sub>1</sub>
	(mm)	1.75 ± 0.10	7.50 ± 0.10	8.00 ± 0.10	4.00 ± 0.10	2.00 ± 0.10	16.00 ± 0.30	14.4 MAX.
	(inch)	0.069 ± 0.004	0.295 ± 0.004	0.315 ± 0.004	0.157 ± 0.004	0.079 ± 0.004	0.630 ± 0.012	0.567 MAX.

Company reserves the right to improve product design, functions and reliability without notice.

## Marking Code

Part Number	Marking Code
Z4DGP406L-HF	Z4GP40JL
Z4DGP408L-HF	Z4GP40KL
Z4DGP410L-HF	Z4GP40ML

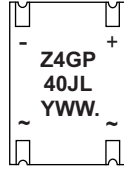

Z4GP = Series code  
 40 = Amps class(4.0A)  
 J = Voltage Class  
 J = 600V  
 K = 800V  
 M = 1000V  
 L = Low VF  
 . = Halogen- free type

Y = Last digit of the year  
 0 = 2010  
 1 = 2011  
 2 = 2012

WW = Mfg week  
 01 = First week  
 02 = Second week  
 03 = Third week

## Suggested PAD Layout

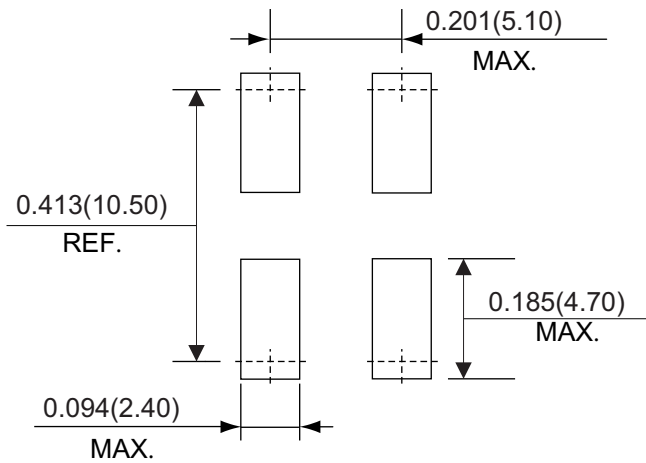

## Standard Packaging

Case Type	REEL PACK	
	REEL ( pcs )	Reel Size (inch)
Z4-D	3,000	13

Company reserves the right to improve product design , functions and reliability without notice.