

nRF C click™

## 1. Introduction

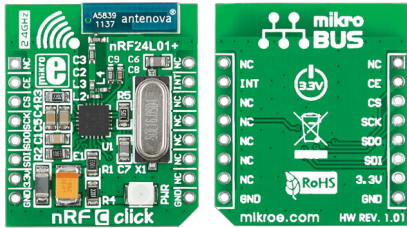

nRF C Click™ is an add-on board in **mikroBUS™** form factor. It's a compact and easy solution for adding 2.4 GHz transceiver to your design. It features **nRF24L01P** 2.4 GHz transceiver module with an embedded baseband protocol engine as well as 2.4 GHz SMD chip antenna. nRF C Click™ communicates with target board microcontroller via **mikroBUS™** SPI (SDI, SDO, SCK, CS#), CE and INT lines. The board is designed to use 3.3V power supply only. LED diode (green) indicates the presence of power supply.

## 2. Soldering the headers

Before using your click board™, make sure to solder 1x8 male headers to both left and right side of the board. Two 1x8 male headers are included with the board in the package.

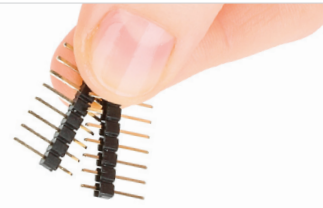

1

2

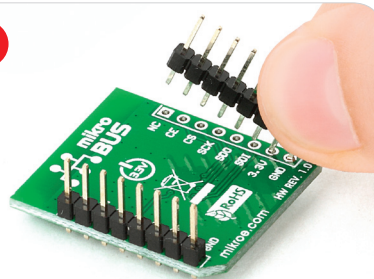

Turn the board upside down so that bottom side is facing you upwards. Place shorter parts of the header pins in both soldering pad locations.

3

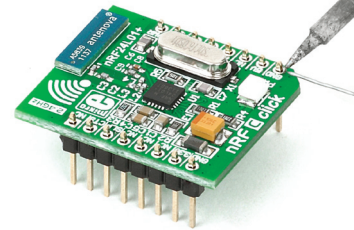

Turn the board upward again. Make sure to align the headers so that they are perpendicular to the board, then solder the pins carefully.

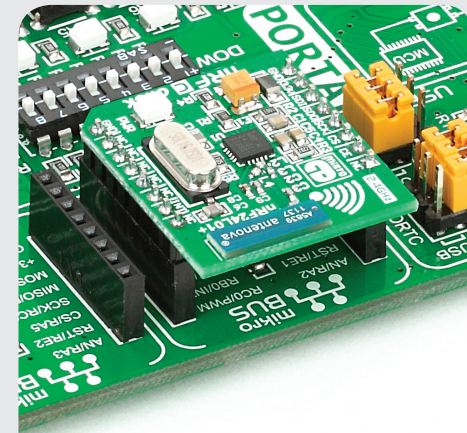

## 4. Essential features

nRF C Click™ with its **nRF24L01P** IC is designed for operation in the world wide ISM frequency band at 2.400 - 2.4835 GHz. The board supports an air data rate of 250 Kbps, 1 Mbps and 2 Mbps and it is suitable for ultra low power designs. All these features make this board ideal for wireless PC peripherals, remotes, VoIP headsets, game controllers, sensors, home and commercial automation, active RFID, toys and many more.

## 3. Plugging the board in

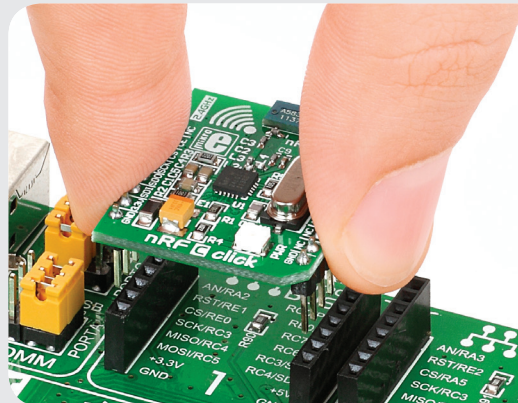

Once you have soldered the headers your board is ready to be placed into desired mikroBUS™ socket. Make sure to align the cut in the lower-right part of the board with the markings on the silkscreen at the mikroBUS™ socket. If all of the pins are aligned correctly, push the board all the way into the socket.

click™  
BOARD  
[www.mikroe.com](http://www.mikroe.com)

nRF C click Manual  
ver. 1.01



0 100000 022306

## 5. nRF C Click™ Board Schematic

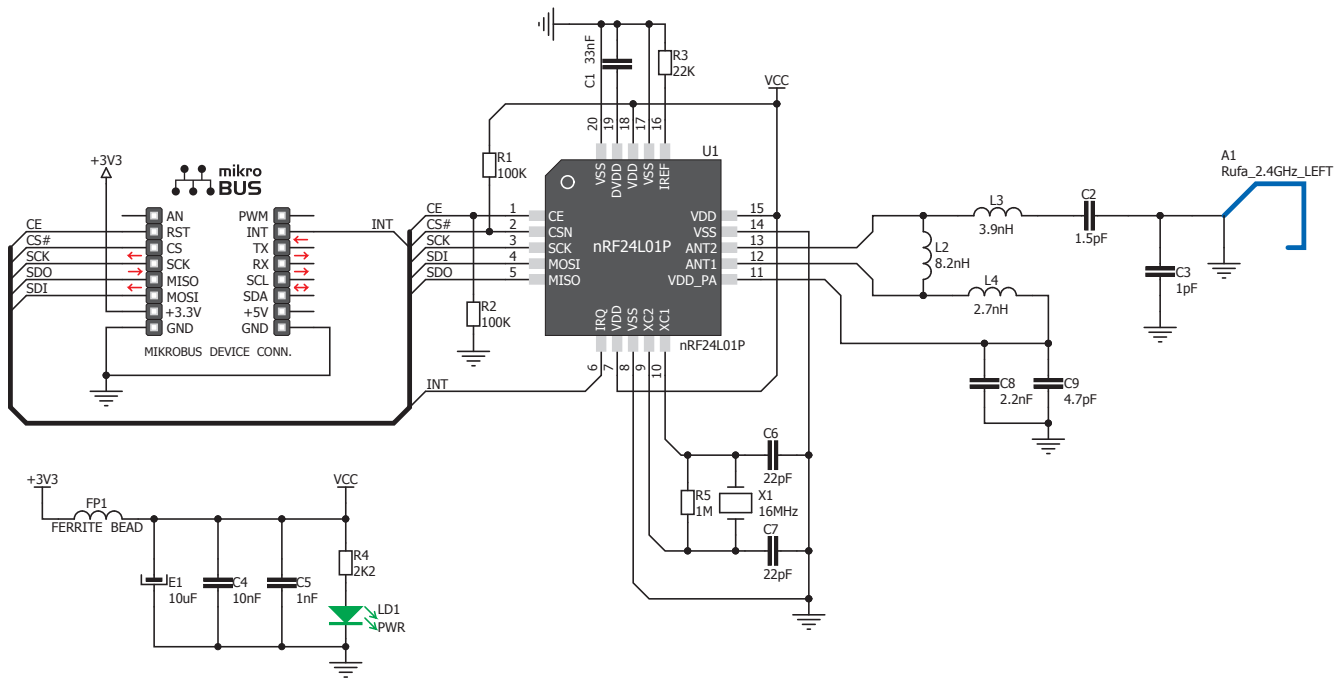

## 6. Chip or Trace antenna?



If you need the board with PCB trace antenna, we recommend you to use other board such as nRF T Click™ :

<http://www.mikroe.com/click/nrf-t/>

## 7. Code Examples

Once you have done all the necessary preparations, it's time to get your click board up and running. We have provided the examples for mikroC, mikroBasic and mikroPascal compilers on our **Libstock** website. Just download them and you are ready to start.



## 8. Support

MikroElektronika offers **Free Tech Support** ([www.mikroe.com/esupport](http://www.mikroe.com/esupport)) until the end of product lifetime, so if something goes wrong, we are ready and willing to help!