

NEW

OMRON

N-Smart

Presence / Detection / Measurement

Smart Fiber Amplifier Units (2-channel models)
E3NX-MA

Greater Flexibility in Equipment Design

Same size as the 1-ch model:
10 mm



installation space by

2-channel Amplifier reduces

1/2

Space-saving and High Performance
Downsized Equipment and Control Panels

Only OMRON provides a 2-ch amplifier that connects to two fiber units.*



EtherCAT 

CC-Link  V2

* Based on November 2017 OMRON investigation.

Downsized Equipment and Control Panels

This new 2-ch fiber amplifier unit has two-unit functions in the dimensions of the general one-unit. You need only half the number of units, substantially contributing to downsizing your equipment and control panels. Moreover, you can substantially reduce the purchase cost, wiring work, and power consumption.



Actual size

General fiber amplifier units

Same number of fiber amplifiers as fiber units are required. Increased installation space prevents design flexibility.



E3NX-MA 2-ch model

Space required for installation reduced by

50%

Larger space enhances design flexibility.

Additionally

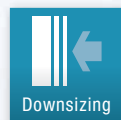

Downsizing the power supply is also possible.

The reduction of power consumption by half* also enables the downsizing of the power supply.

* Compared with E3NX-FA.

Stable detection

From transparent objects to low-reflective workpieces

Performance with Highly Stable Detection even with Two Channels

High Performance

Sensing Distance 4 m For E32-LT11 Fiber Unit with a fiber length of 3.5 m	Minimum Sensing Object 0.6 μm dia. For E32-D11R Fiber Unit
---	--

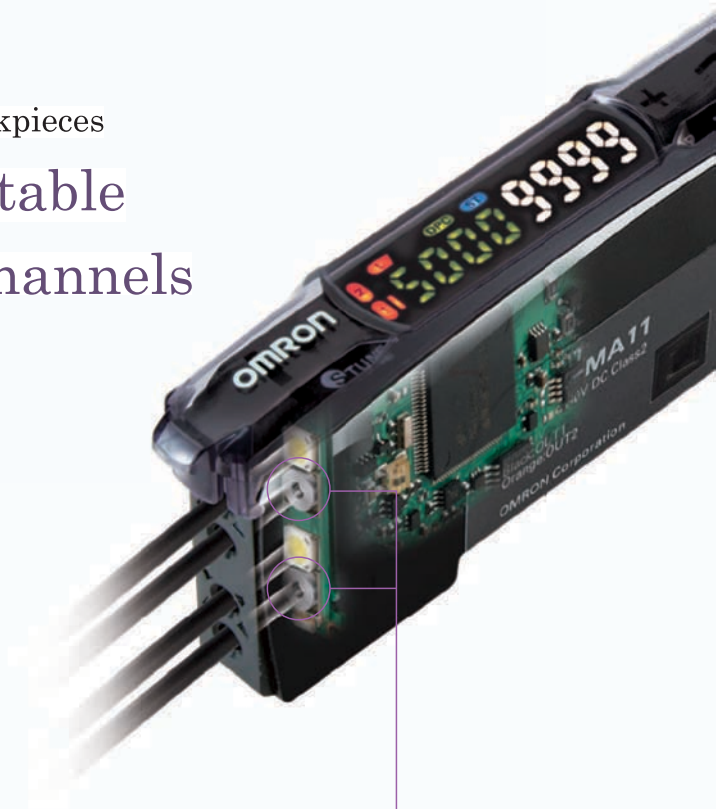

Technologies That Realize Basic Performance

Powerful and Uniform Emission without Lost Light

HIGH-EFFICIENCY COUPLING ELEMENT

GIGA RAY2S

PAT

Optical Coupling Efficiency of **40%**

Since the distance between the fiber and the LED is short, light is transmitted without loss. The lens and reflector emit powerful, uniform emission.

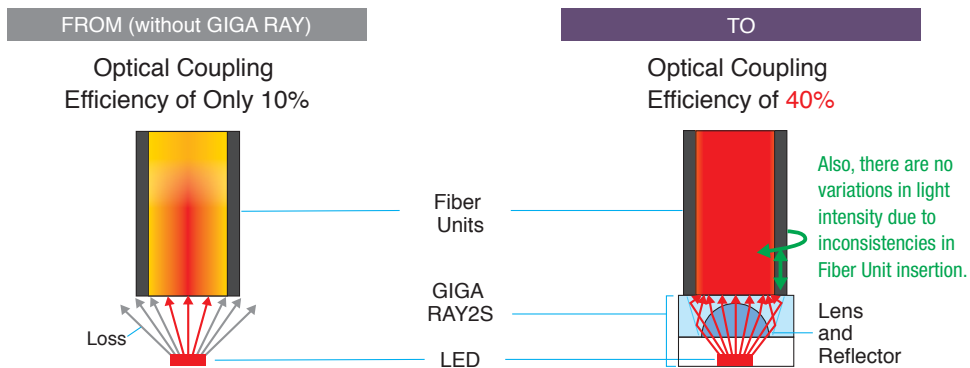

Low Noise to Accurately Capture Signals

LIGHT RECEPTION ALGORITHM

Smart Noise Reduction

The influences of noise are reduced to achieve stable incident light levels by increasing the number of samples taken. This increases the margin for threshold values to achieve stable detection.

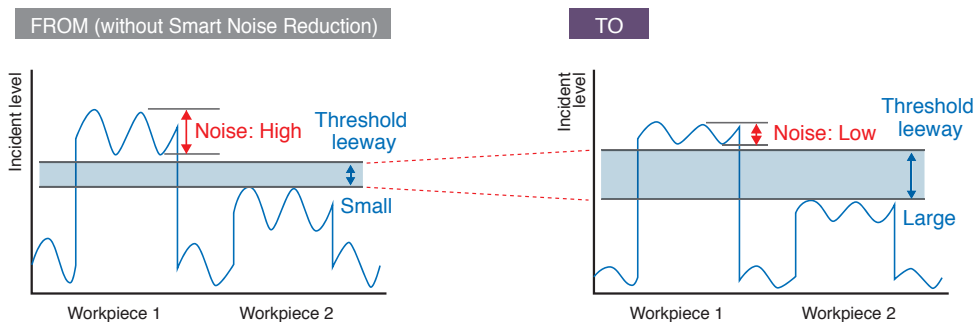

Easy operation

With the Press of a Single Button

Anyone can Easily Set the Light Intensity and Threshold Automatically

Consistent Settings for All Users **Smart Tuning Settings** PAT

E3NX-MA Press the **S TUNE** button **once** with a workpiece and **once** without a workpiece



Automatically set the light intensity and threshold to optimum values in **1 Step**.

Threshold	Incident Level
5000	9999

Set to the intermediate value between the incident levels with and without a workpiece.

Incident level adjustment with and without a workpiece.

Automatic Adjustment to Optimum Incident Level **Wide Light Intensity Adjustment Range from Transparent Objects to Black Workpieces**

Excessive Incident Level

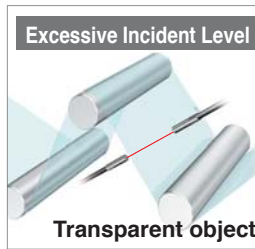

Transparent object

Insufficient Incident Level



Black workpiece

Light intensity reduced

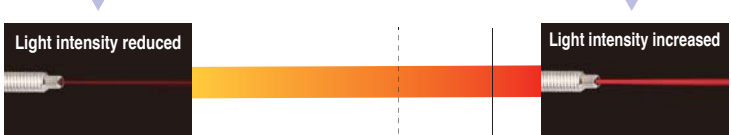

Light intensity increased

Conventional Models* (x1/100) (Light intensity adjustment range) x1

Wider light intensity adjustment range of 40,000 times (Conventional models*: 2,000 times)
You can automatically adjust the light intensity to an optimum value for stable detection even with saturated or insufficient incident light.

*. E3X-HD

Reliable function

Two Decision Support Functions to Help You

Visual Displays of the Passing Time and Difference in Incident Levels.

Solution Viewer PAT

Selecting Fiber Units
Just about anyone can make a quantitative decision without special skills.

A

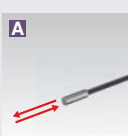

4.1 1003

Passing time Difference in incident level

B

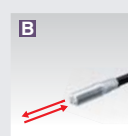

4.1 4999

Passing time Difference in incident level

The difference in incident level is large, so use B.

Setting Optimum Thresholds and Modes

You can see the passing time and difference in incident levels to facilitate manual setup.



13.7 4000

Passing time Difference in incident level

The passing time is "13 ms", so it is OK with Standard Mode.

The incident light level difference is 4,000 when the level is 5,000 with a workpiece, so a threshold of 3,000 is OK.

Visual Information for Fast Workpieces **Change Finder** PAT

You can confirm changes in displayed values for fast workpieces to accurately set the threshold.

Conventional model

9999

9999

9999

Display could not keep up with the workpiece speed.

E3NX-MA

9999

5000

5000

9999

Displayed for 500 ms.

The display value for the passing workpiece can be read.

Before passing

While passing

After passing

Wire-saving Connector Models Reduce Wiring Work

Power is supplied from the Master Connector; the Slave Connectors have output lines only. Since there are no Master/Slave distinctions in amplifier units, you can unify the stock into one model type.

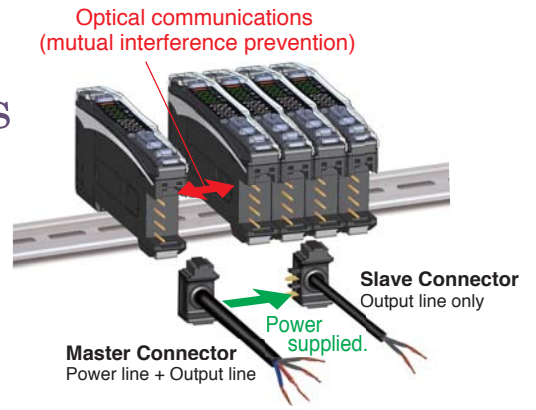

Conventional fiber amplifier units

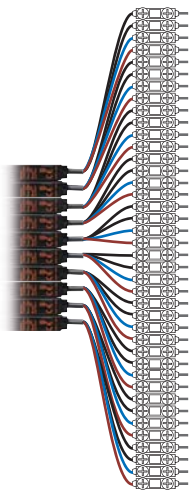

Total **30** lines

Output lines: 10
Power lines: 2 lines x 10 units = 20 lines

Each amplifier unit requires power and output lines.

E3NX-MA
Pre-wired model

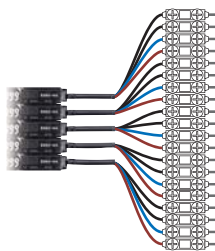

Total **20** lines

Output lines: 10
Power lines: 2 lines x 5 units = 10 lines

Each amplifier unit requires power and output lines.

E3NX-MA
Wire-saving Connector model

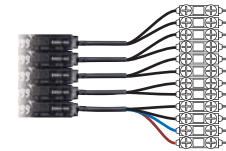

Total **12** lines

Output lines: 10
Power lines: 2 lines x 1 units = 2 lines

Power is supplied to every amplifier unit via the Master Connector.

Reduction of wiring work by **60%** * When connecting 10 channels.

More Wire-saving and Improved Productivity with Network Communications

Use Sensor Communications Units to save more wiring and remotely control up to 15 amplifier units (total 30 channels). Full-view screen for 2-ch threshold and light intensity is available; Collective setting reduces equipment commissioning time. The system monitors equipment conditions for preventive maintenance, and reduces downtime in case of trouble, enabling safe and stable operation of equipment.

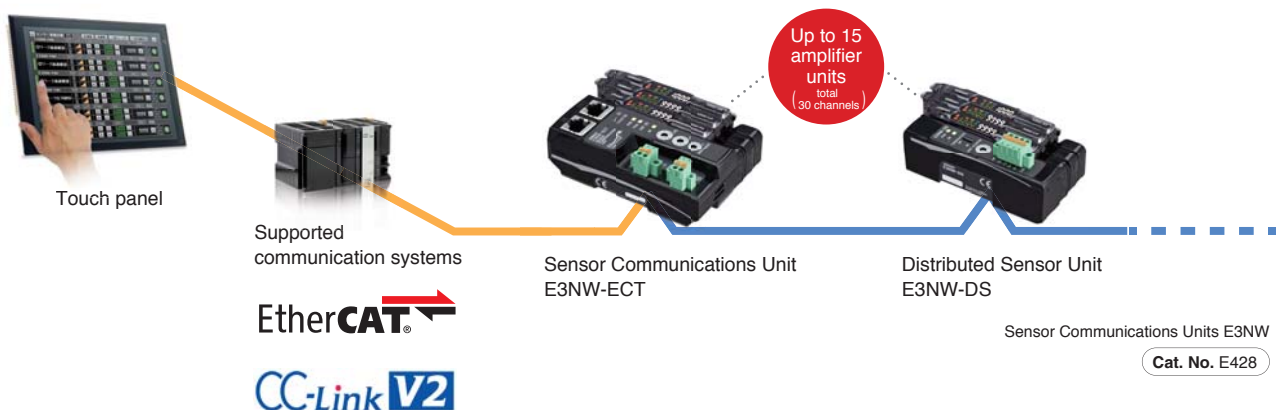

Control outputs through numerical or logical operations are possible.

A Single Sensor can Handle a Wide Range of Applications

Discrimination through numerical operations

Mark detection by discriminating the gap between the sheet and the mark

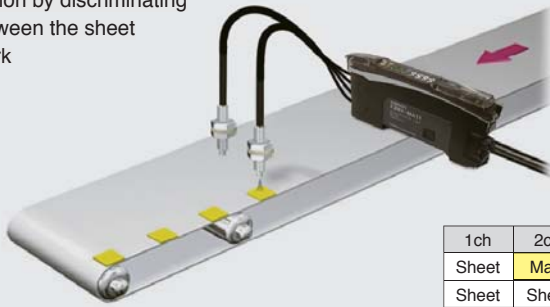

1ch	2ch	Result
Sheet	Mark	There is a gap.
Sheet	Sheet	There is no gap.

One single fiber amplifier can perform a numerical operation (difference) between two light intensities and discriminate based on the figure.

Operation example

1ch	2ch	Operation result
1000	2000	-1000
5600	500	5100

Control output through logical operations

Output of the logical operation results between 1-ch and 2-ch sensing is possible.

AND discrimination

Inspection of lead frame feeding position

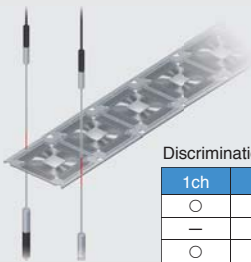

Discrimination example

1ch	2ch	Output
○	○	○
—	○	—
○	—	—
—	—	—

OR discrimination

Fall detection by using two area fiber units

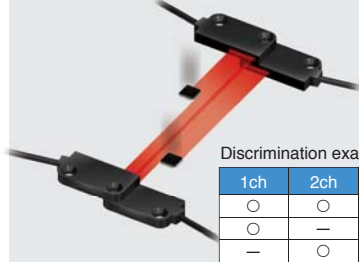

Discrimination example

1ch	2ch	Output
○	○	○
○	—	○
—	○	○
—	—	—

One single fiber amplifier can provide control outputs based on AND operation or OR operation between two sensors, without using a PLC or a sensor controller.



XOR discrimination

Detection of cap presence regardless of the direction of the workpieces

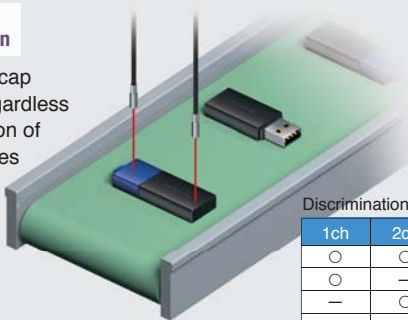

Discrimination example

1ch	2ch	Output
○	○	—
○	—	○
—	○	○
—	—	—

Rising synchronization

Detection of cap presence when the workpiece passes

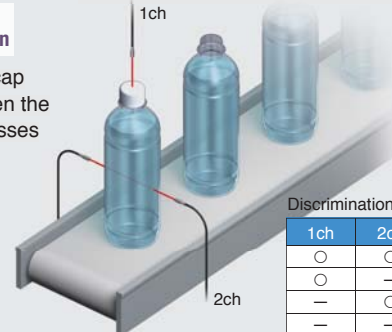

Discrimination example

1ch	2ch	Output
○	○	○
○	—	—
—	○	—
—	—	—

Reference

Output pattern of logical operations

Outputs discriminating the combination of operational results are possible: AND operation outputs when both 1ch and 2ch are turned ON, OR operation outputs when either 1ch or 2ch is turned ON, and XOR operation outputs when only either 1ch or 2ch is turned ON.

Discrimination		Output		
1ch	2ch	AND	OR	XOR
○	○	○	○	×
○	×	×	○	○
×	○	×	○	○
×	×	×	×	×

1ch 2ch

1ch 2ch

1ch 2ch

Ordering Information

Fiber Amplifier Units

Type	Connecting method	Appearance	Inputs/outputs	Model	
				NPN output	PNP output
2-channel models *2	Standard Type	Pre-wired (2 m)	2 outputs	E3NX-MA11	E3NX-MA41
		Wire-saving Connector		E3NX-MA6	E3NX-MA8
	Model for Sensor Communications Unit *1	Connector for Sensor Communications Unit	---	E3NX-MA0	

*1. A Sensor Communications Unit is required if you want to use the Fiber Amplifier Unit on a network.

*2. Two Fiber Units can be connected to one Fiber Amplifier Unit.

Accessories (Sold Separately)

Wire-saving Connectors

(Required for models for Wire-saving Connectors.)

Connectors are not provided with the Fiber Amplifier Unit and must be ordered separately. Note: Protective stickers are attached. Cable length is 2 m.

Type	No. of conductors	Model	Applicable Fiber Amplifier Units
Master Connector	4	E3X-CN21	E3NX-MA6 E3NX-MA8
Slave Connector	2	E3X-CN22	E3NX-MA8

Related Products

Sensor Communications Units

Type	Model
Sensor Communications Unit for EtherCAT	E3NW-ECT
Sensor Communications Unit for CC-Link	E3NW-CCL
Distributed Sensor Unit *	E3NW-DS

Refer to your OMRON website for details.

* The Distributed Sensor Unit can be connected to any of the Sensor Communications Units.

Ratings and Specifications

Item	Type	Standard Type		Model for Sensor Communications Unit	
	NPN output	PNP output	E3NX-MA11	E3NX-MA6	E3NX-MA0
			E3NX-MA41	E3NX-MA8	
Connecting method		Pre-wired	Wire-saving Connector	Connector for Sensor Communications Unit	
Inputs/outputs	Outputs	2 outputs		---	
	External inputs	---	---		
Light source (wavelength)	Red, 4-element LED (625 nm)				
Power supply voltage	10 to 30 VDC, including 10% ripple (p-p)			Supplied from the connector through the Sensor Communications Unit	
Power consumption	At Power supply voltage of 24 VDC Normal mode : 960 mW max. (Current consumption at 40 mA max.) Eco function ON: 770 mW max. (Current consumption at 32 mA max.) Eco function LO : 870 mW max. (Current consumption at 36 mA max.)				
Control output	Load power supply voltage: 30 VDC max., open-collector output (depends on the NPN/PNP output format) Load current: Groups of 1 to 3 Amplifier Units: 100 mA max., Groups of 4 to 30 Amplifier Units: 20 mA max. Residual voltage: At load current of less than 10 mA: 1 V max. At load current of 10 to 100 mA: 2 V max. OFF current: 0.1 mA max.			---	
Response time	Super-high-speed mode (SHS)	Operate or reset: 100 μs			
	High-speed mode (HS)	Operate or reset: 450 μs			
	Standard mode (Std)	Operate or reset: 1ms			
	Giga-power mode (GIGA)	Operate or reset: 16ms			
No. of Units for mutual interference prevention	9 Note: The mutual interference prevention function is disabled if the detection mode is set to super-high-speed mode.				
Functions	Auto power control (APC), dynamic power control (DPC), timer, zero reset, resetting settings, eco mode, bank switching, power tuning, and hysteresis width				

Note: For details, refer to the Smart Fiber Amplifier Units E3NX-MA Datasheet (Cat No.E467)

E3NX-FA Fiber Amplifier Units
Cat. No. E426
Stable Detection with the No. 1 Performance*

E3NX-CA Color Fiber Amplifier Unit
Cat. No. Y216
High Color Discrimination Capability

E3NC Smart Laser Sensors
Cat. No. E427
From Minute Workpieces to Long-distance Detection

E9NC-T Contact-Type Smart Sensor
Cat. No. E433
Handles Advanced Measurement Applications

E2NC Smart Proximity Sensor
Cat. No. E473
High-precision sensitivity setting is easy.

E9NC-AA/VA Smart Condition Monitoring Amplifier
Cat. No. E474
Available soon
Various condition-monitoring sensors are connected.

N-Smart
Presence Detection Measurement

N-Smart Amplifier Units
Easy application with consistent operating procedures.

Applications with Many Sensors:
More convenience and even lower costs with a network.

EtherCAT
CC-Link V2

* For performance (sensing distance and minimum sensing object) based on November 2017 OMRON investigation.

Common Features and Models in the N-Smart Series

Common Buttons

Intuitive Operation and Easy Setup.

White Characters on a Black background

High-contrast displays for easy visibility from a distance.

For the Fiber Sensor lineup, see

Fiber Sensor Best Selection Catalog

With this one you can select the optimum Fiber Unit and Fiber Amplifier Unit!

Cat. No. E418

EtherCAT® is a registered trademark and patented technology, licensed by Beckhoff Automation GmbH, Germany.
CC-link is a registered trademark of Mitsubishi Electric Corporation. The trademark is managed by the CC-link Partner Association.

OMRON Corporation Industrial Automation Company
Kyoto, JAPAN

Contact: www.ia.omron.com

Regional Headquarters

OMRON EUROPE B.V.
Wegalaan 67-69, 2132 JD Hoofddorp
The Netherlands
Tel: (31)2356-81-300/Fax: (31)2356-81-388

OMRON ASIA PACIFIC PTE. LTD.
No. 438A Alexandra Road # 05-05/08 (Lobby 2),
Alexandra Technopark,
Singapore 119967
Tel: (65) 6835-3011/Fax: (65) 6835-2711

OMRON ELECTRONICS LLC
2895 Greenspoint Parkway, Suite 200
Hoffman Estates, IL 60169 U.S.A.
Tel: (1) 847-843-7900/Fax: (1) 847-843-7787

OMRON (CHINA) CO., LTD.
Room 2211, Bank of China Tower,
200 Yin Cheng Zhong Road,
PuDong New Area, Shanghai, 200120, China
Tel: (86) 21-5037-2222/Fax: (86) 21-5037-2200

Authorized Distributor:

© OMRON Corporation 2017-2018 All Rights Reserved.
In the interest of product improvement,
specifications are subject to change without notice.
CSM_1_4_0618

Cat. No. E466-E1-02

0318 (1117)