

### UltraCMOS® SPDT RF Switch 100–6000 MHz

#### Features

- HaRP™ technology enhanced
  - No gate and phase lag
  - No drift in insertion loss and phase
- High linearity
  - IIP3 of 65 dBm
- High isolation
  - 69 dB @ 1 GHz
  - 62 dB @ 3 GHz
  - 50 dB @ 6 GHz
- Supports +1.8V control logic
- +105 °C operating temperature
- High ESD tolerance
  - 4 kV HBM on RFC
  - 2 kV HBM on all other pins

#### Product Description

The PE42420 is a HaRP™ technology-enhanced absorptive SPDT RF switch designed for use in 3G/4G wireless infrastructure and other high performance RF applications. It is ideal for transmit path switching, RF and IF signal routing, AGC loops, and filter bank switching applications.

This general purpose switch is comprised of two symmetric RF ports and has exceptional port to port isolation up to 6 GHz. An integrated CMOS decoder facilitates a two-pin low voltage CMOS control interface. In addition, no external blocking capacitors are required if 0 VDC is present on the RF ports.

The PE42420 is manufactured on Peregrine's UltraCMOS® process, a patented variation of silicon-on-insulator (SOI) technology on a sapphire substrate.

Peregrine's HaRP technology enhancements deliver high linearity and excellent harmonics performance. It is an innovative feature of the UltraCMOS process, offering the performance of GaAs with the economy and integration of conventional CMOS.

**Figure 1. Functional Diagram**

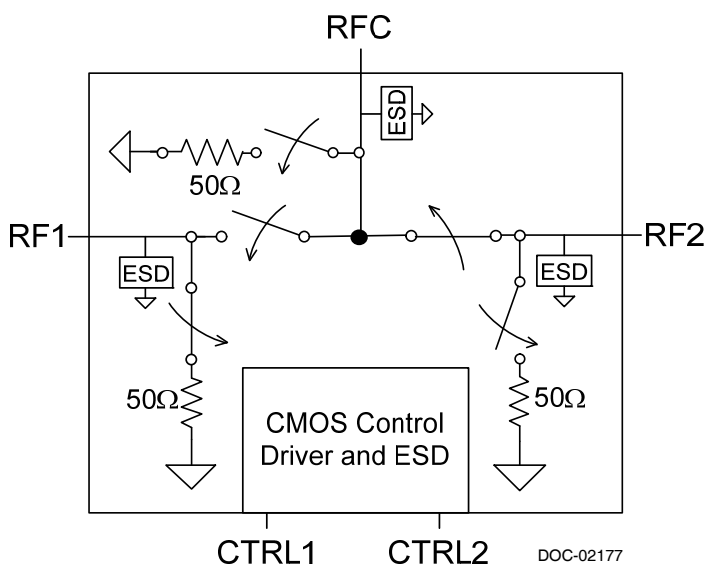

**Figure 2. Package Type**  
20-lead 4 × 4 mm LGA

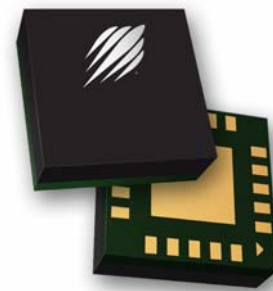

**Table 1. Electrical Specifications @ +25 °C, V<sub>DD</sub> = 3.0V (Z<sub>S</sub> = Z<sub>L</sub> = 50Ω)**

Parameter	Path	Condition	Min	Typ	Max	Unit
Operating frequency			100		6000	MHz
Insertion loss	RFC–RFX	100–1000 MHz		0.95	1.15	dB
		1000–2000 MHz		0.95	1.15	dB
		2000–3000 MHz <sup>1</sup>		1.00	1.20	dB
		3000–4000 MHz <sup>1</sup>		1.15	1.35	dB
		4000–5000 MHz <sup>1</sup>		1.25	1.55	dB
		5000–6000 MHz <sup>1</sup>		1.60	1.90	dB
Isolation	RFX–RFX	100–1000 MHz	67	69		dB
		1000–2000 MHz	63	64		dB
		2000–3000 MHz	59	62		dB
		3000–4000 MHz	60	64		dB
		4000–5000 MHz	54	60		dB
		5000–6000 MHz	44	50		dB
Isolation	RFC–RFX	100–1000 MHz	69	71		dB
		1000–2000 MHz	65	67		dB
		2000–3000 MHz	63	68		dB
		3000–4000 MHz	62	67		dB
		4000–5000 MHz	52	57		dB
		5000–6000 MHz	44	48		dB
Return loss (all ports)		100–4000 MHz		20		dB
		4000–5000 MHz <sup>1</sup>		15		dB
		5000–6000 MHz <sup>1</sup>		13		dB
Input 1dB compression point <sup>2</sup>	RFC–RFX	100–6000 MHz	33			dBm
Input IP2	RFC–RFX	100–6000 MHz		110		dBm
Input IP3	RFC–RFX	100–6000 MHz	60	65		dBm
Switching time		50% CTRL to 90% or 10% RF		300	400	ns

Notes: 1. Insertion loss and return loss can be improved by external matching.

2. The input 1dB compression point is a linearity figure of merit. Refer to *Table 3* for the maximum operating power P<sub>IN</sub> (50Ω).

**Table 1A. Electrical Specifications @ +105 °C, V<sub>DD</sub> = 2.3V to 5.5V (Z<sub>S</sub> = Z<sub>L</sub> = 50Ω)**

Parameter	Path	Condition	Min	Typ	Max	Unit
Operating frequency			100		6000	MHz
Insertion loss	RFC–RFX	100–1000 MHz		1.05	1.25	dB
		1000–2000 MHz		1.10	1.35	dB
		2000–3000 MHz <sup>1</sup>		1.25	1.45	dB
		3000–4000 MHz <sup>1</sup>		1.35	1.75	dB
		4000–5000 MHz <sup>1</sup>		1.50	2.00	dB
		5000–6000 MHz <sup>1</sup>		1.60	2.00	dB
Isolation	RFX–RFX	100–1000 MHz	66	68		dB
		1000–2000 MHz	63	64		dB
		2000–3000 MHz	59	62		dB
		3000–4000 MHz	60	64		dB
		4000–5000 MHz	54	60		dB
		5000–6000 MHz	44	50		dB
Isolation	RFC–RFX	100–1000 MHz	68	70		dB
		1000–2000 MHz	65	67		dB
		2000–3000 MHz	62	67		dB
		3000–4000 MHz	62	67		dB
		4000–5000 MHz	51	55		dB
		5000–6000 MHz	44	48		dB
Return loss (all ports)		100–4000 MHz		19		dB
		4000–5000 MHz <sup>1</sup>		15		dB
		5000–6000 MHz <sup>1</sup>		13		dB
Input 1dB compression point <sup>2</sup>	RFC–RFX	100–6000 MHz	33			dBm
Input IP2	RFC–RFX	100–6000 MHz		110		dBm
Input IP3	RFC–RFX	100–6000 MHz	60	65		dBm
Switching time		50% CTRL to 90% or 10% RF		300	400	ns

Notes: 1. Insertion loss and return loss can be improved by external matching.

2. The input 1dB compression point is a linearity figure of merit. Refer to *Table 3* for the maximum operating power P<sub>IN</sub> (50Ω).

Figure 3. Pin Configuration (Top View)

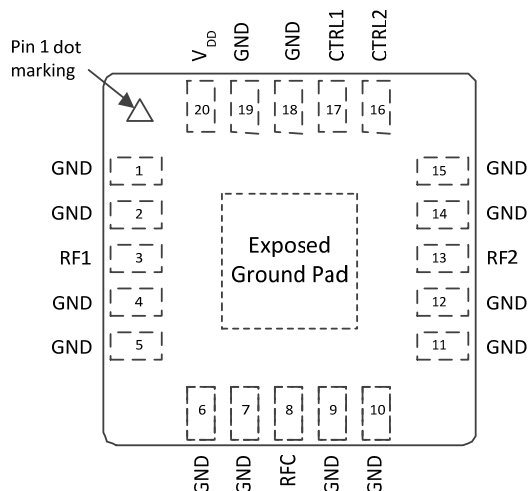

Table 2. Pin Descriptions

Pin #	Pin Name	Description
1, 2, 4-7, 9, 10-12, 14, 15, 18, 19	GND	Ground
3	RF1*	RF port
8	RFC*	RF common
13	RF2*	RF port
16	CTRL2	Digital control logic input 2
17	CTRL1	Digital control logic input 1
20	V <sub>DD</sub>	Supply voltage
Pad	GND	Exposed pad: ground for proper operation

Note: \* RF pins 3, 8 and 13 must be at 0 VDC. The RF pins do not require DC blocking capacitors for proper operation if the 0 VDC requirement is met.

Table 3. Operating Ranges

Parameter	Symbol	Min	Typ	Max	Unit
Supply voltage	V <sub>DD</sub>	2.7		5.5	V
Supply current V <sub>DD</sub> = 2.7-5.5V	I <sub>DD</sub>		120	200	μA
Digital input high (CTRL1, CTRL2)	V <sub>IH</sub>	1.17		3.6	V
Digital input low (CTRL1, CTRL2)	V <sub>IL</sub>	-0.3		0.6	V
Digital input current	I <sub>CTRL</sub>		9	12	μA
Maximum operating power (RFC-RFX)*	P <sub>IN</sub>			30	dBm
Maximum power into termination (RFX)*	P <sub>MAX</sub>			20	dBm
Operating temperature range	T <sub>OP</sub>	-40		+105	°C

Note: \* 100% duty cycle, all bands, 50Ω.

Table 4. Absolute Maximum Ratings

Parameter/Condition	Symbol	Min	Max	Unit
Supply voltage	V <sub>DD</sub>	-0.3	5.5	V
Digital input voltage (CTRL1, CTRL2)	V <sub>CTRL</sub>	-0.3	3.6	V
Operating power (RFC-RFX) <sup>1</sup>	P <sub>IN</sub>		30	dBm
Power into termination (RFX) <sup>1</sup>	P <sub>MAX</sub>		20	dBm
Storage temperature range	T <sub>ST</sub>	-65	+150	°C
Maximum die junction temperature	T <sub>JMAX</sub>		+125	°C
ESD voltage HBM <sup>2</sup> RFC All other pins	V <sub>ESD</sub>		4000 2000	V V
ESD voltage MM <sup>3</sup> , all pins	V <sub>ESD</sub>		100	V

Notes: 1. 100% duty cycle, all bands, 50Ω.  
2. Human Body Model (MIL-STD 883 Method 3015).  
3. Machine Model (JEDEC JESD22-A115).

Exceeding absolute maximum ratings may cause permanent damage. Operation should be restricted to the limits in the Operating Ranges table. Operation between operating range maximum and absolute maximum for extended periods may reduce reliability.

### Electrostatic Discharge (ESD) Precautions

When handling this UltraCMOS device, observe the same precautions that you would use with other ESD-sensitive devices. Although this device contains circuitry to protect it from damage due to ESD, precautions should be taken to avoid exceeding the specified rating.

### Latch-Up Immunity

Unlike conventional CMOS devices, UltraCMOS devices are immune to latch-up.

### Switching Frequency

The PE42420 has a maximum 25 kHz switching frequency.

Switching frequency describes the time duration between switching events. Switching time is the time duration between the point the control signal reaches 50% of the final value and the point the output signal reaches within 10% or 90% of its target value. Switching time is provided in *Table 1*.

**Table 5. Truth Table**

CTRL1	CTRL2	RFC-RF1	RFC-RF2
Low	Low	OFF	OFF
Low	High	OFF	ON
High	Low	ON	OFF
High	High	N/A*	N/A*

Note: \* CTRL1 = High and CTRL2 = High are not supported

### Moisture Sensitivity Level

The Moisture Sensitivity Level rating for the PE42420 in the 20-lead 4 × 4 mm LGA package is MSL3.

### Spurious Performance

The typical spurious performance of the PE42420 is -155 dBm.

Typical Performance Data @ +25 °C and  $V_{DD} = 3.0V$ , unless otherwise specified

Figure 4. Insertion Loss (RFC–RFX)

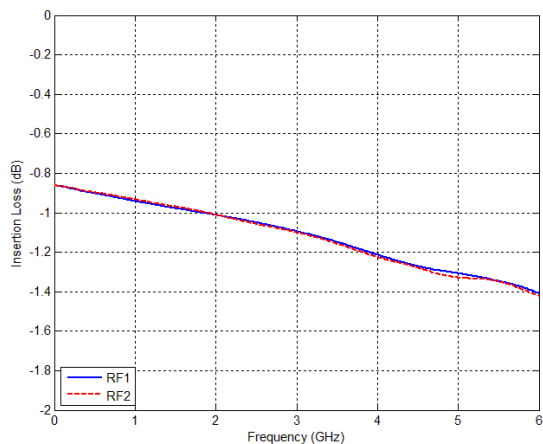

Figure 5. Insertion Loss vs Temp (RFX–RFC)

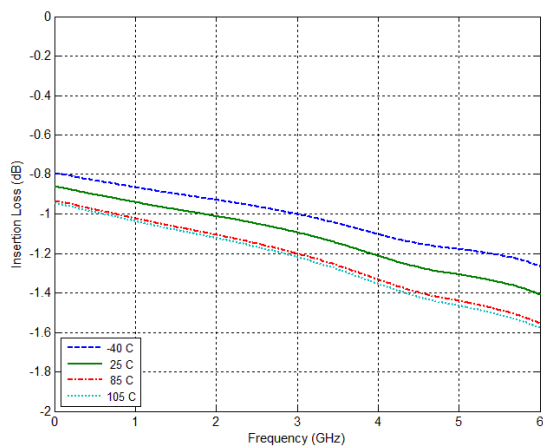

Figure 6. Insertion Loss vs  $V_{DD}$  (RFX–RFC)

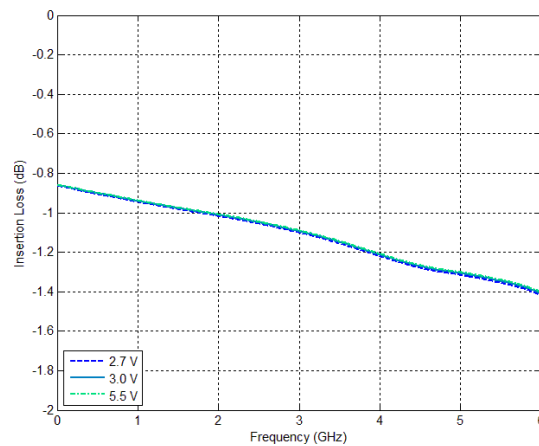

Figure 7. RFC Port Return Loss vs Temp (RF1 Active)

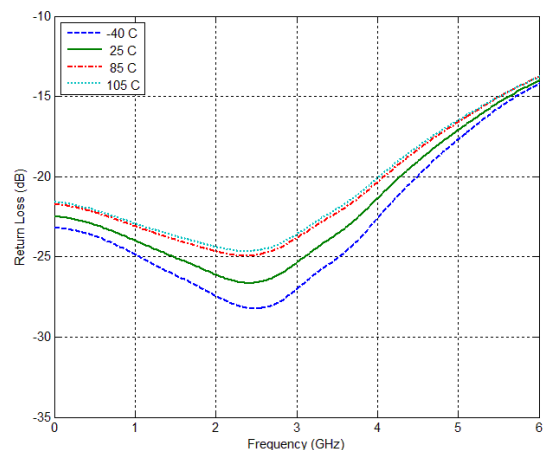
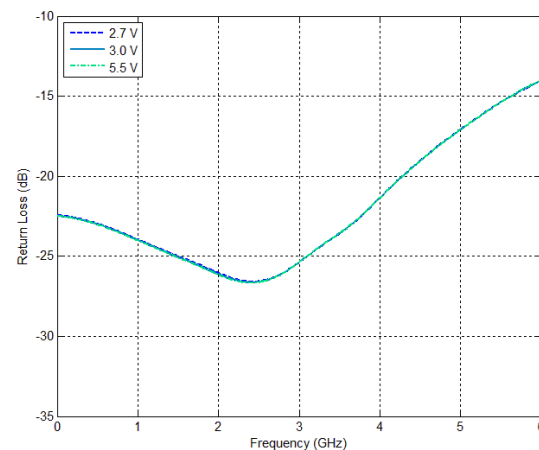

Figure 8. RFC Port Return Loss vs  $V_{DD}$  (RF1 Active)



Typical Performance Data@ +25 °C and  $V_{DD} = 3.0V$ , unless otherwise specified (continued)

Figure 9. RFC Port Return Loss vs Temp (RF2 Active)

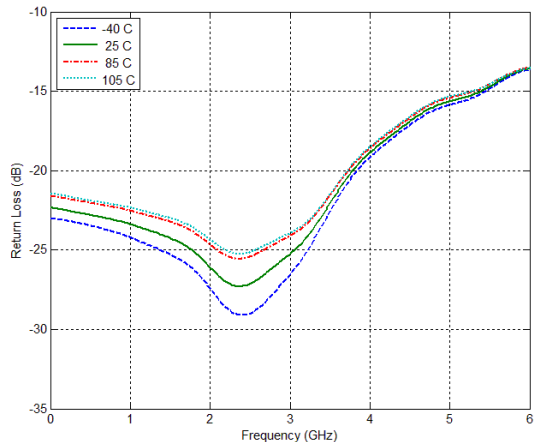

Figure 10. RFC Port Return Loss vs  $V_{DD}$  (RF2 Active)

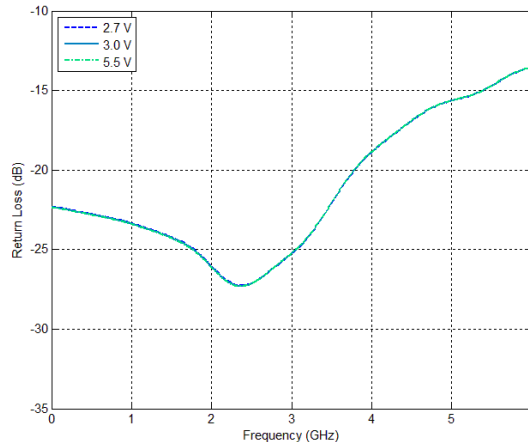

Figure 11. Active Port Return Loss vs Temp (RF1 Active)

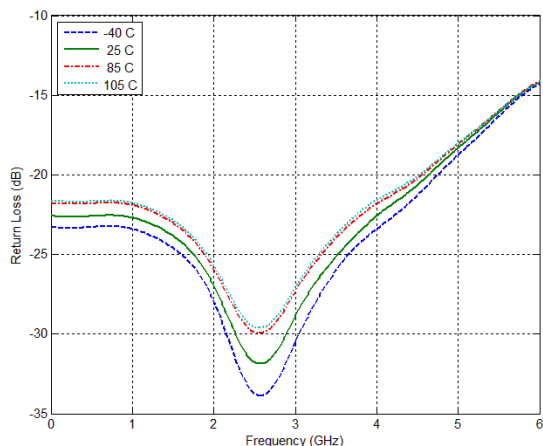

Figure 12. Active Port Return Loss vs  $V_{DD}$  (RF1 Active)

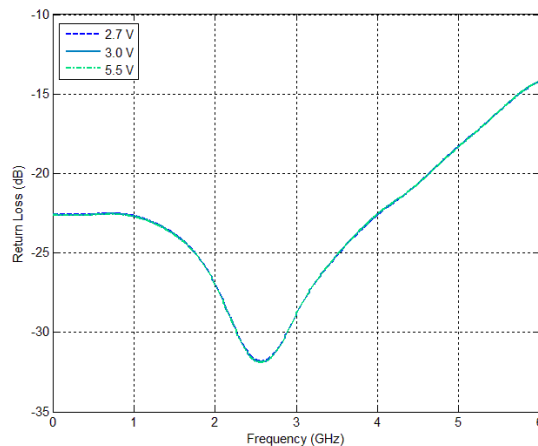

Figure 13. Terminated Port Return Loss vs Temp (RF1 Active)

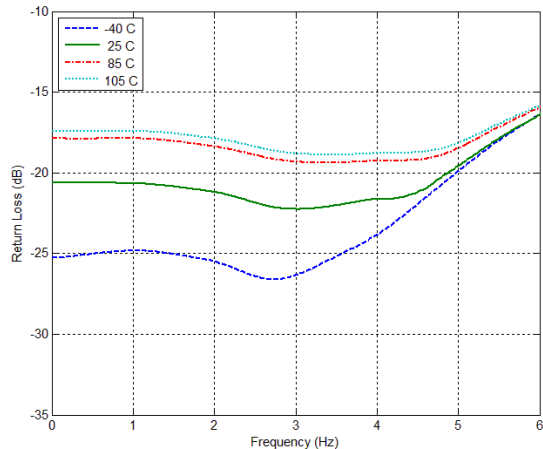
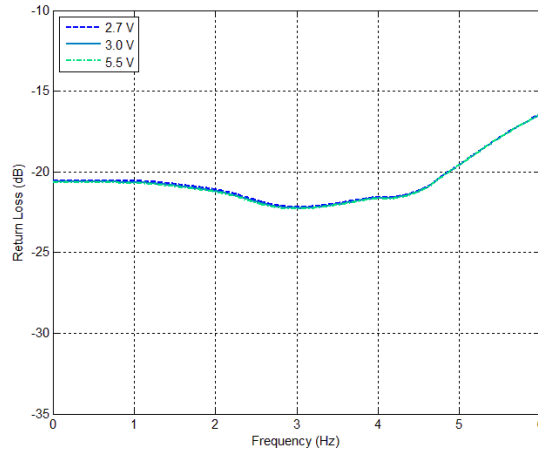
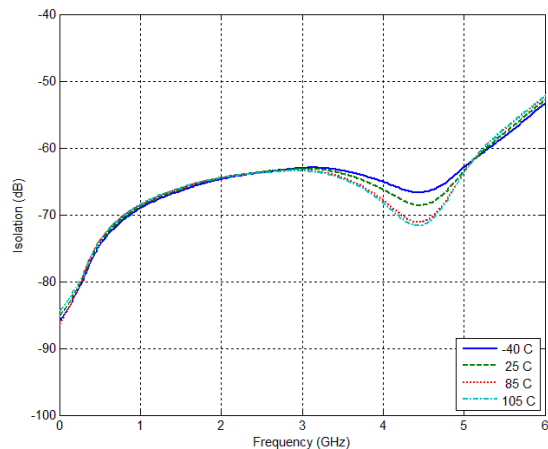

Figure 14. Terminated Port Return Loss vs  $V_{DD}$  (RF1 Active)



**Typical Performance Data@ +25 °C and  $V_{DD} = 3.0V$ , unless otherwise specified (continued)**

**Figure 15. Isolation vs Temp (RFX–RFX)**



**Figure 16. Isolation vs  $V_{DD}$  (RFX–RFX)**

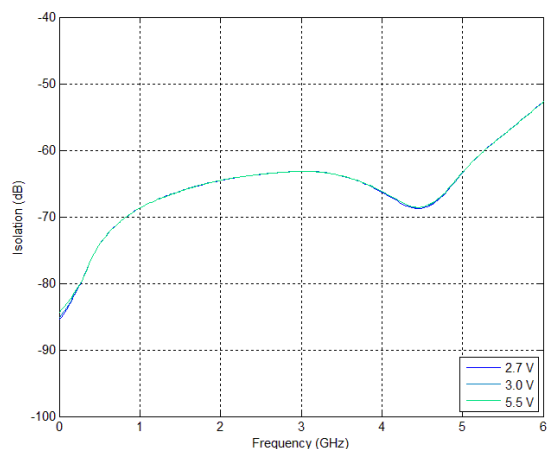

**Figure 17. Isolation vs Temp (RFC–RFX)**

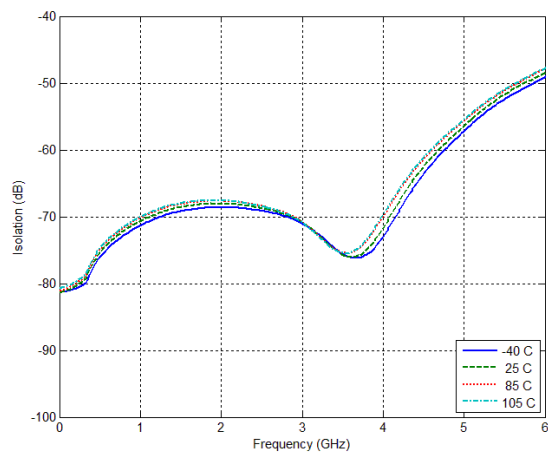

**Figure 18. Isolation vs  $V_{DD}$  (RFC–RFX)**

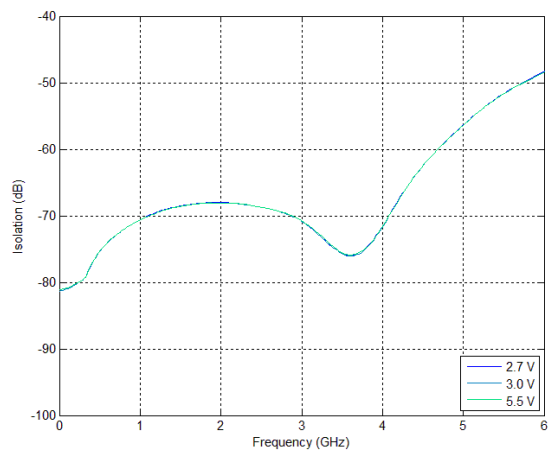



## Evaluation Kit

The SPDT switch evaluation board was designed to ease customer evaluation of Peregrine's PE42420. The RF common port is connected through a 50 $\Omega$  transmission line via the top SMA connector, J2. RF1 and RF2 ports are connected through 50 $\Omega$  transmission lines via SMA connectors J1 and J3, respectively. A 50 $\Omega$  through transmission line is available via SMA connectors J4 and J5, which can be used to calculate the loss of the PCB. J6 provides DC and digital inputs to the device.

The board is constructed of a four metal layer material with a total thickness of 36 mils. To achieve high isolation, the 50 $\Omega$  transmission lines are designed in layer 2 using a stripline waveguide design. The board stack up for 50 $\Omega$  transmission lines has 10 mil thickness of Rogers 4350 between layer 1 and layer 2, and 10 mil thickness of Rogers 4350 between layer 2 and layer 3.

For the true performance of the PE42420 to be realized, the PCB should be designed in such a way that RF transmission lines and sensitive DC I/O traces are heavily isolated from one another.

Figure 19. Evaluation Board Layout

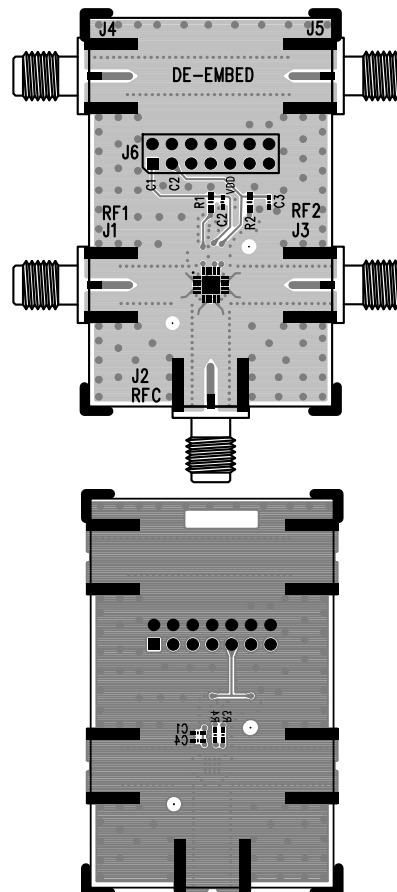

PRT-11505

Figure 20. Evaluation Board Schematic

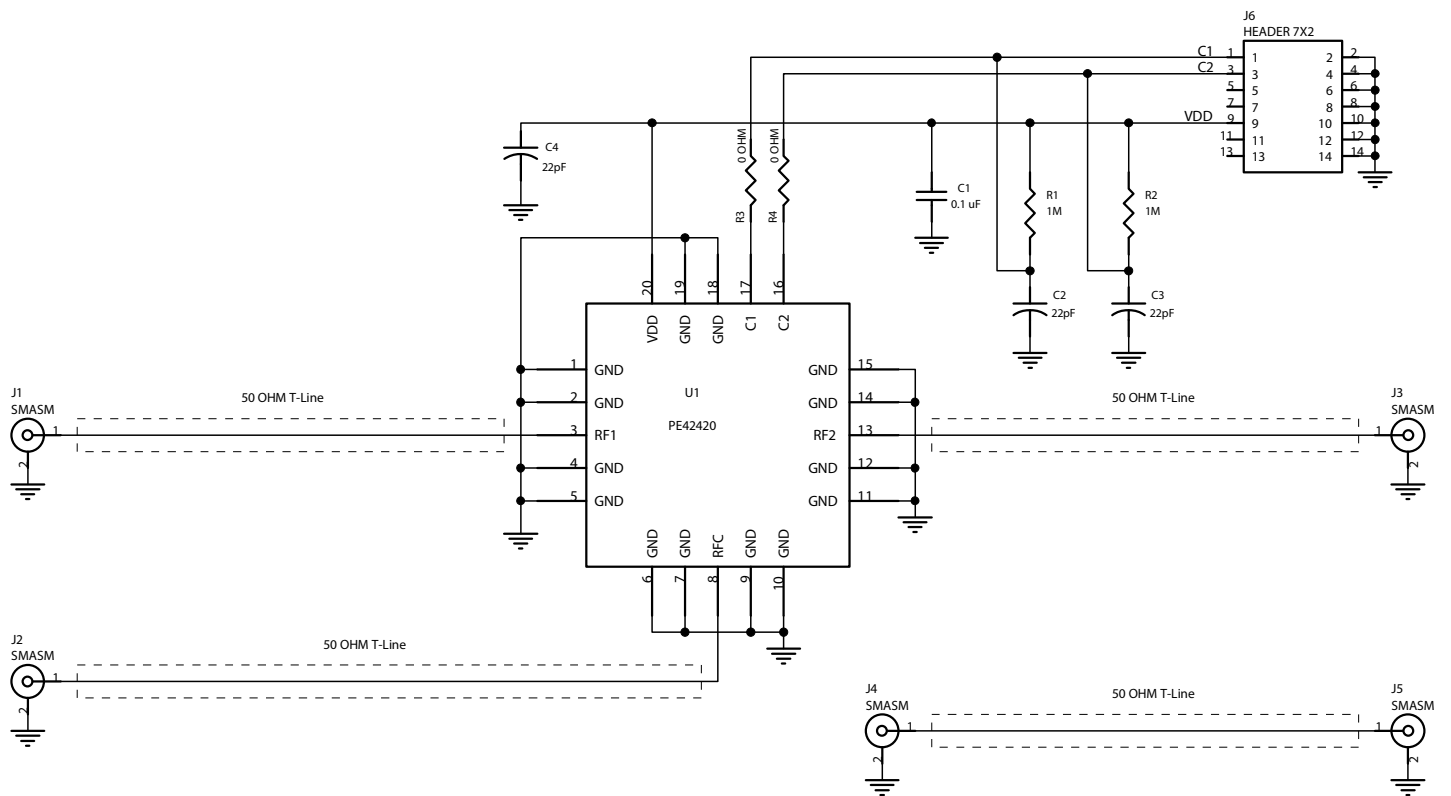

DOC-14527

**Figure 21. Package Drawing**  
20-lead 4 × 4 mm LGA

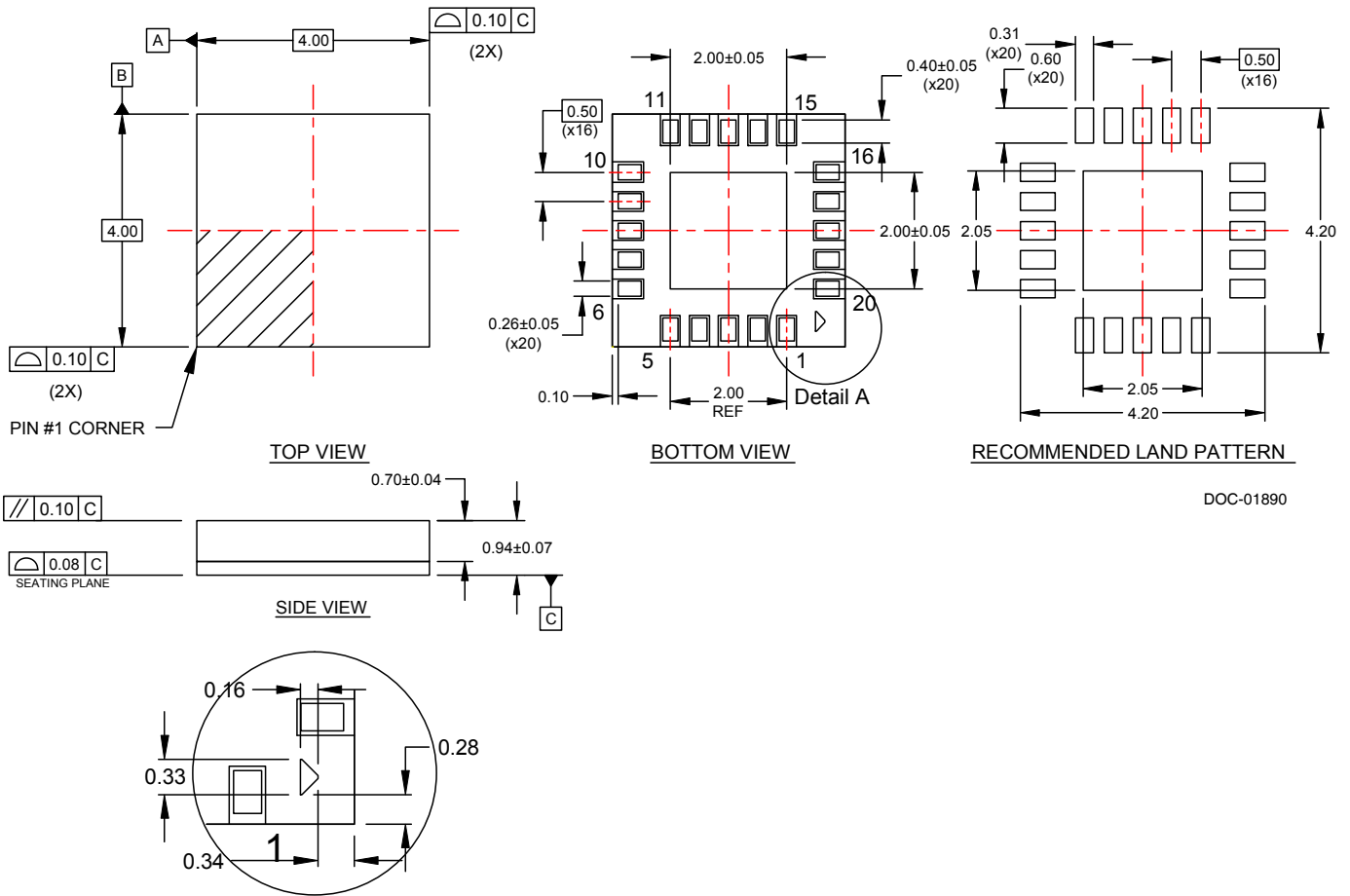

**Figure 22. Top Marking Specifications**

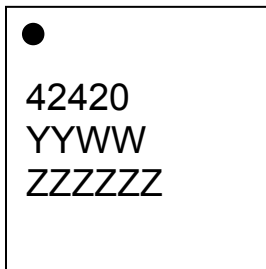

DOC-65737

- = Pin 1 designator
- YYWW = Last 2 digits of assembly year, starting from 2010
- ZZZZZZ = Assembly lot code (max 6 characters)

**Figure 23. Tape and Reel Drawing**

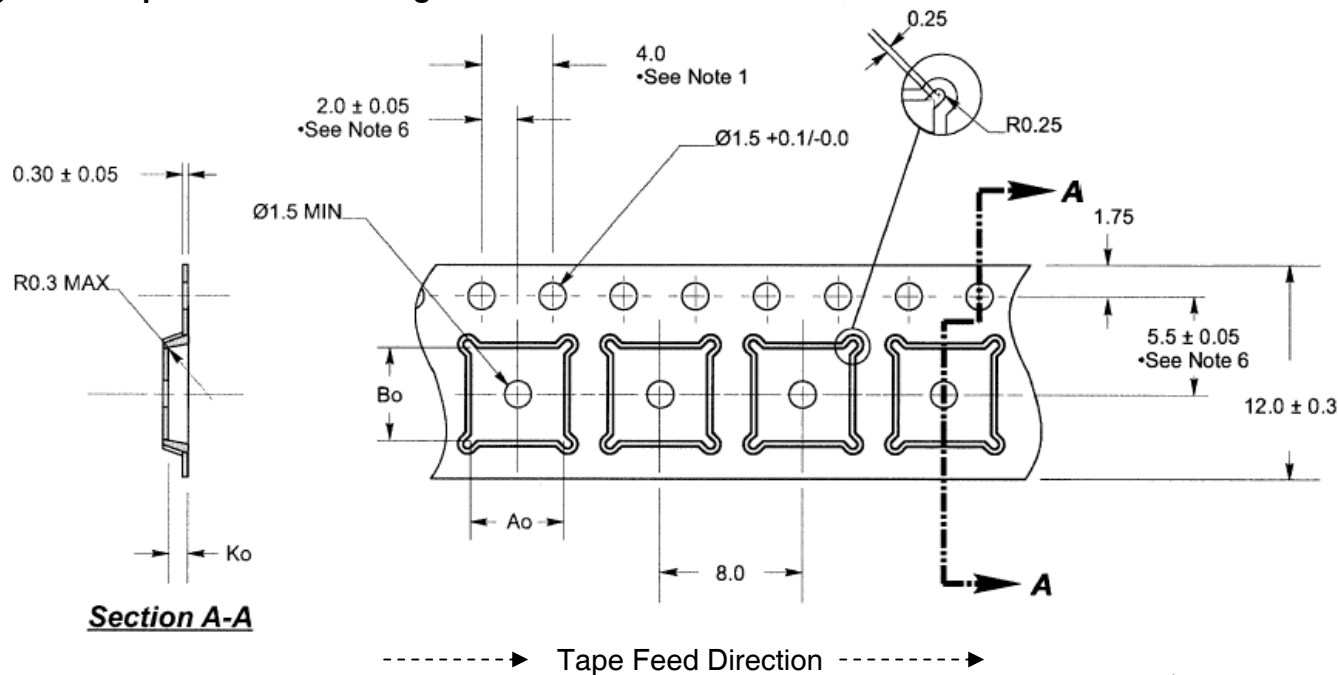

- Notes:
1. 10 sprocket hole pitch cumulative tolerance  $\pm 0.02$ .
  2. Camber not to exceed 1 mm in 100 mm.
  3. Material: PS + C.
  4.  $A_o$  and  $B_o$  measured as indicated.
  5.  $K_o$  measured from a plane on the inside bottom of the pocket to the top surface of the carrier.
  6. Pocket position relative to sprocket hole measured as true position of pocket, not pocket hole.

$A_o = 4.35$  mm  
 $B_o = 4.35$  mm  
 $K_o = 1.1$  mm

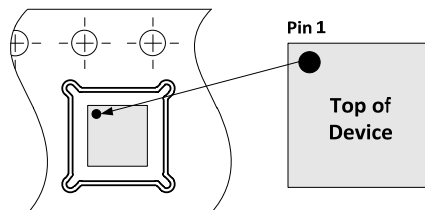

Device Orientation in Tape

**Table 6. Ordering Information**

Order Code	Description	Package	Shipping Method
PE42420C-Z	PE42420 SPDT RF switch	Green 20-lead 4 x 4 mm LGA	3000 units / T&R
EK42420C-02	PE42420 Evaluation kit	Evaluation kit	1 / Box

## Sales Contact and Information

For sales and contact information please visit [www.psemi.com](http://www.psemi.com).

**Advance Information:** The product is in a formative or design stage. The datasheet contains design target specifications for product development. Specifications and features may change in any manner without notice.  
**Preliminary Specification:** The datasheet contains preliminary data. Additional data may be added at a later date. Peregrine reserves the right to change specifications at any time without notice in order to supply the best possible product. **Product Specification:** The datasheet contains final data. In the event Peregrine decides to change the specifications, Peregrine will notify customers of the intended changes by issuing a CNF (Customer Notification Form).  
 The information in this datasheet is believed to be reliable. However, Peregrine assumes no liability for the use of this information. Use shall be entirely at the user's own risk.

No patent rights or licenses to any circuits described in this datasheet are implied or granted to any third party. Peregrine's products are not designed or intended for use in devices or systems intended for surgical implant, or in other applications intended to support or sustain life, or in any application in which the failure of the Peregrine product could create a situation in which personal injury or death might occur. Peregrine assumes no liability for damages, including consequential or incidental damages, arising out of the use of its products in such applications.

The Peregrine name, logo, UltraCMOS and UTSi are registered trademarks and HaRP, MultiSwitch and DuNE are trademarks of Peregrine Semiconductor Corp. Peregrine products are protected under one or more of the following U.S. Patents: <http://patents.psemi.com>.