



**ZEPIR0AxS02MODG**

# **ZMOTION™ Detection Module**

**Product Specification**

PS028408-0312





**Warning:** DO NOT USE IN LIFE SUPPORT SYSTEMS.

---

## **LIFE SUPPORT POLICY**

ZILOG'S PRODUCTS ARE NOT AUTHORIZED FOR USE AS CRITICAL COMPONENTS IN LIFE SUPPORT DEVICES OR SYSTEMS WITHOUT THE EXPRESS PRIOR WRITTEN APPROVAL OF THE PRESIDENT AND GENERAL COUNSEL OF ZILOG CORPORATION.

### **As used herein**

Life support devices or systems are devices which (a) are intended for surgical implant into the body, or (b) support or sustain life and whose failure to perform when properly used in accordance with instructions for use provided in the labeling can be reasonably expected to result in a significant injury to the user. A critical component is any component in a life support device or system whose failure to perform can be reasonably expected to cause the failure of the life support device or system or to affect its safety or effectiveness.

### **Document Disclaimer**

©2012 Zilog, Inc All rights reserved. Information in this publication concerning the devices, applications, or technology described is intended to suggest possible uses and may be superseded. ZILOG, INC. DOES NOT ASSUME LIABILITY FOR OR PROVIDE A REPRESENTATION OF ACCURACY OF THE INFORMATION, DEVICES, OR TECHNOLOGY DESCRIBED IN THIS DOCUMENT. ZILOG ALSO DOES NOT ASSUME LIABILITY FOR INTELLECTUAL PROPERTY INFRINGEMENT RELATED IN ANY MANNER TO USE OF INFORMATION, DEVICES, OR TECHNOLOGY DESCRIBED HEREIN OR OTHERWISE. The information contained within this document has been verified according to the general principles of electrical and mechanical engineering.

ZMOTION and Z8 Encore! XP are trademarks or registered trademarks of Zilog, Inc. (an IXYS Company). All other product or service names are the property of their respective owners.

# Revision History

Each instance in the revision history table reflects a change to this document from its previous revision. For more details, refer to the corresponding pages or appropriate links given in the table below.

Date	Revision Level	Description	Page
Mar 2012	08	Added Rev B part to Ordering Information table.	<a href="#">56</a>
Apr 2011	07	Update to Module photo; correction to Light Gate description.	<a href="#">2, 5</a>
Nov 2010	06	Updated to new Zilog/IXYS logo.	All
Oct 2010	05	Replaced all instances of ePIR with advanced passive infrared.	All
Sep 2010	04	Fixed formatting and pagination issues.	All
Sep 2010	03	Replaced Zilog logos, ePIR with ZMOTION, and Zdots with Module. Updated <a href="#">Figure 11</a> .	All
Oct 2008	02	Updated Related Products section (changed 88-pin SOIC to 28-pin SOIC for Z8FS040AHJ20SG). Removed references to GP and General Purpose.	<a href="#">52</a>
Oct 2008	01	Original issue.	All

# Table of Contents

Revision History .....	iii
List of Figures .....	vi
List of Tables .....	vii
Architectural Overview .....	1
Features .....	1
ZEPiR0AAS02MODG Block Diagram .....	2
Pin Description .....	3
Operational Modes .....	4
Setting Operation Mode .....	4
Signal Descriptions, Hardware Interface Mode .....	5
Ground .....	5
Supply Voltage .....	5
Delay .....	5
Sensitivity .....	6
Motion Detect .....	6
Light Gate .....	6
SLEEP Mode .....	6
Signal Descriptions, Serial Interface Mode .....	7
Ground .....	7
Supply Voltage .....	7
Receive Data .....	7
Transmit Data .....	7
Motion Detect and Reset .....	7
Light Gate .....	8
SLEEP Mode .....	8
Voltage Brown-Out Protection and Power-On Reset .....	8
Operation .....	10
Hardware Interface Mode .....	10
SLEEP Mode in Hardware Interface Mode .....	10
Serial Interface Mode .....	11
SLEEP Mode in Serial Interface Mode .....	11
Serial Interface Commands and Description .....	12
Serial Commands .....	16
Motion Status Command .....	16
Light Gate Level Commands .....	17

MD/RST Pin Configuration .....	19
MD Activation Time .....	21
Hyper Sense .....	22
Hyper Sense Level Setting .....	24
Frequency Response Setting .....	26
Motion Detection Suspend .....	28
Software Revision .....	30
Serial Interface Command Mode .....	31
Motion Detected Unsolicited Mode .....	33
MD Current Active Output Time .....	35
Ping .....	37
Range Setting .....	39
Sensitivity .....	41
Directional Detection .....	43
Module Reset .....	46
Sleep Mode .....	48
Detection Pattern .....	49
Mechanical Information .....	50
ZMOTION Detection Module Schematic .....	52
Related Documents .....	53
Related Products .....	53
Electrical Characteristics .....	54
Absolute Maximum Ratings .....	55
Ordering Information .....	56
Part Numbers .....	56
Appendix A. Hardware Interface Mode .....	57
Appendix B. Serial Interface Mode .....	58
Appendix C. Software Revisions .....	59
Customer Support .....	60

# List of Figures

Figure 1. ZMOTION Block Diagram (ZEPIR0AAS02MODG) . . . . .	2
Figure 2. The ZMOTION Detection Module (Shown: ZEPIR0AAS02MODG) . . . . .	3
Figure 3. Power-On Reset Operation . . . . .	9
Figure 4. Voltage Brown-Out Reset Operation . . . . .	9
Figure 5. Read Command Structure . . . . .	12
Figure 6. Write Command Structure . . . . .	13
Figure 7. Confirmed Command Structure . . . . .	13
Figure 8. Detection Pattern . . . . .	49
Figure 9. Mechanical Drawing of the ZMOTION Detection Module (ZEPIR0AAS02MODG) . . . . .	50
Figure 10. Mechanical Drawing of the ZMOTION Detection Module (ZEPIR0ABS02MODG) . . . . .	51
Figure 11. Schematic of ZMOTION Detection Module . . . . .	52
Figure 12. Application Example, Hardware Interface Mode . . . . .	57
Figure 13. Application Example, Serial Interface Mode . . . . .	58

# List of Tables

Table 1.	Pin Description . . . . .	3
Table 2.	Delay Time and Voltage on DLY . . . . .	5
Table 3.	Summary of Serial Interface Commands . . . . .	15
Table 4.	Shortcuts to Light Gate Level Commands . . . . .	17
Table 5.	MD Output Activation Time Values. . . . .	21
Table 6.	MD Output Activation Time Values. . . . .	31
Table 7.	MD Output Activation Time Values. . . . .	35
Table 8.	Shortcuts to Directional Detection Commands. . . . .	43
Table 9.	Shortcuts to Module Reset Commands. . . . .	46
Table 10.	Electrical Characteristics . . . . .	54
Table 11.	Absolute Maximum Ratings . . . . .	55
Table 12.	Part Numbers . . . . .	56
Table 13.	ZMOTION Detection Module Software Revision (Application Software) . .	59
Table 14.	ZMOTION Software Engine Revision . . . . .	59

# Architectural Overview

Zilog's ZMOTION Detection Module is a complete motion detection solution ideally suited for applications that need to detect a human presence. It is an excellent solution for detecting people as they approach entrances, kiosks, product displays, vending machines, appliances and advertising displays.

The ZMOTION Detection Module is a board-level module that combines the unique features of Zilog's Z8FS040 Motion Detection microcontroller with a pyroelectric sensor and a low-profile lens. The surface-mount pyroelectric sensor and lens combine to provide the lowest possible profile without sacrificing performance. The module is only 25.5 mm x 16.7 mm (and less than 10mm thick) so it can easily fit into many size constrained applications.

The ZMOTION Detection Module is simple to use. It can operate in **HARDWARE Mode** – which simply activates an output signal when motion is detected – or in **SERIAL Mode**, allowing it to *talk* to another processor in your system when greater control over motion detection performance is required. In both modes, sensitivity and output activation time can be controlled to match application requirements. For applications that require ambient light sensing, an input supporting an external light sensor is provided for gating motion detection output.

The ZMOTION Detection Module provides an easy, low-risk solution for your motion detection requirements.

## Features

Key features of the ZMOTION Detection Module include:

- Complete low-profile motion detection solution
- Small form factor: 25.5 mm x 16.7 mm
- Up to 5 m x 5 m, 60-degree detection pattern
- Simple-to-use **HARDWARE Mode** or advanced **SERIAL Mode (UART)**
- Flexible control over sensitivity and output activation time
- **SLEEP Mode** for low power applications
- Support for Ambient Light Sensor input
- Unique Hyper Sense feature automatically increases sensitivity after motion is detected
- Minimal components ensure high reliability
- Application code can be modified to support custom solutions
- Complete evaluation system available
- 8-pin interface connector with two orientations available (right-angle and straight)
- Operates from a 2.7 V to 3.6 V power supply
- Standard operating temperature range: 0°C to 70°C



# ZEPIR0AxS02MODG Block Diagram

Figure 1 displays a block diagram of the ZMOTION Detection Module.



Figure 1. ZMOTION Block Diagram (ZEPIR0AxS02MODG)

Figure 2 displays the ZMOTION Detection Module.

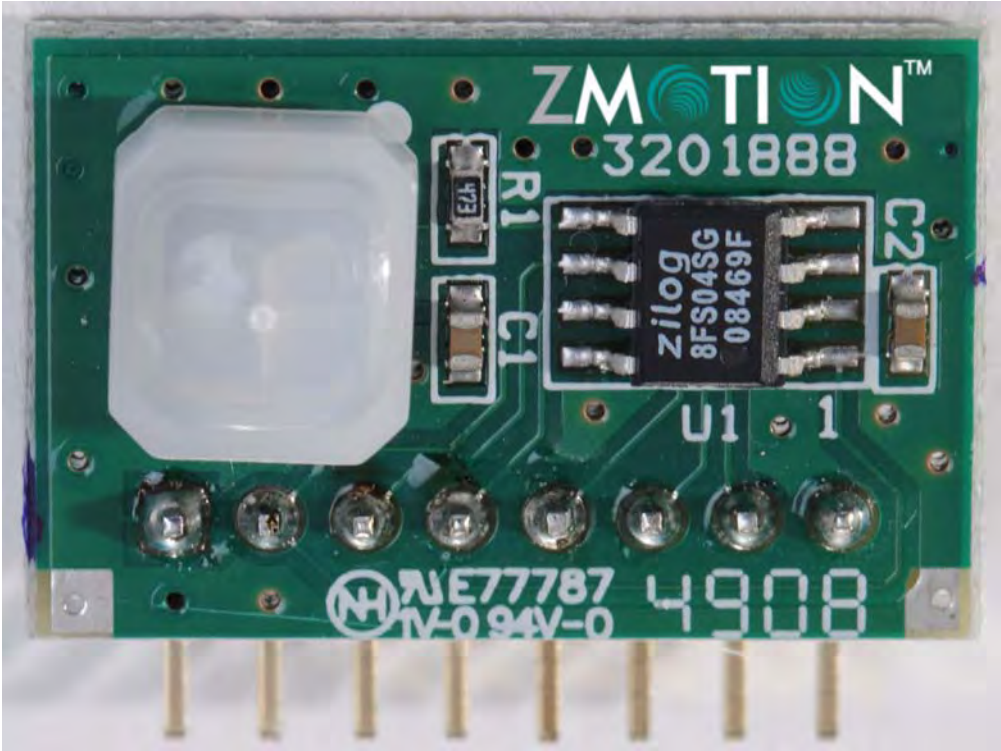

Figure 2. The ZMOTION Detection Module (Shown: ZEPIR0AAS02MODG)

## Pin Description

Table 1 lists the pin and signal descriptions for the ZMOTION Detection Module.

**Table 1. Pin Description**

Pin#	Signal Name	Hardware Interface Mode	Serial Interface Mode	Comments
1	GND	Ground	Ground	—
2	V <sub>DD</sub>	Supply Voltage	Supply Voltage	—
3	RXD/DLY	Delay (DLY; analog input)	RXD — Receive Data (digital input)	—
4	TXD/SNS	Sensitivity (SNS; analog input)	TXD — Transmit Data (digital output)	Mode Select during reset
5	$\overline{\text{MD/RST}}$	Motion Detect (digital output)	Configurable: Reset ( $\overline{\text{RST}}$ ; digital input); Motion Detect (MD; digital input)	Default is Reset ( $\overline{\text{RST}}$ ) in Serial Interface Mode.
6	LG	Light Gate (analog input)	Light Gate (analog input)	If unused, connect to V <sub>DD</sub> .
7	$\overline{\text{SLP/DBG}}$	Sleep ( $\overline{\text{SLP}}$ ; digital input)	Sleep ( $\overline{\text{SLP}}$ ; digital input)	DBG is used for programming and debug.
8	GND	Ground	Ground	—

## Operational Modes

The ZMOTION Detection Module operates in both Hardware Interface and Software Interface modes; each is described in this section.

Hardware Interface Mode:

- Provides basic configuration via the hardware interface pins
- Allows you to adjust sensitivity and delay
- Offers optional ambient light input
- Includes a SLEEP Mode to reduce power consumption

Serial Interface Mode:

- Provides advanced configuration and status via a serial interface
- $\overline{\text{MD}}$ , LG and  $\overline{\text{SLP}}$  remain functional
- The serial interface runs at: 9600 bps, no parity, 8 data bits, 1 stop bit and no flow control

## Setting Operation Mode

This section briefly outlines how to set Module operation in either Serial Interface or Hardware Interface modes.

### Serial Interface Mode Selection

To select Serial Interface Mode, provide a pull up resistor from TXD/SNS to  $V_{DD}$  during power ON or when exiting SLEEP Mode (typically 100K $\Omega$ ). The device detects that the voltage on the pin is greater than 2.5V and enables the TXD and RXD signals.  $\overline{MD}$ , LG and SLP remain active also. This resistor will have no effect on the transmitted data.

### Hardware Interface Mode Selection

The Hardware Interface Mode is selected when TXD/SNS is between 0V and 1.8V during power ON or when exiting SLEEP Mode.

For examples of using the ZMOTION Detection Module in Hardware and Serial Interface Modes, see [Appendix A. Hardware Interface Mode](#) on page 57 and [Appendix B. Serial Interface Mode](#) on page 58.

## Signal Descriptions, Hardware Interface Mode

This section describes the signals for operating in Hardware Interface mode.

### Ground

Both Pin 1 and the Pin 8 ground (GND) signals are tied together on the ZMOTION Detection Module SBC and are connected to power ground.

### Supply Voltage

The supply voltage ( $V_{DD}$ ) provides power to the ZMOTION Detection Module via Pin 2. For power consumption details, see the [Electrical Characteristics](#) chapter on page 54.

### Delay

A high-impedance analog input, Pin 3 (RXD/DLY), sets the duration for the Motion Detect ( $\overline{MD}$ ) pin to remain active when motion has been detected. Provide a voltage between 0V and 2V to select a delay of 2 seconds to 15 minutes (see Table 2). Typically, a simple resistor divider or trim pot is used to set the voltage.

**Table 2. Delay Time and Voltage on DLY**

Delay Time	Voltage on DLY
2 sec	0V
5 sec	0.2V
10 sec	0.4V
30 sec	0.6V
1 min	0.8V
2 min	1.0V
3 min	1.2V
5 min	1.4V
10 min	1.6V
15 min	1.8V

## Sensitivity

A high-impedance analog input, Pin 4 (TXD/SNS) sets the Module's sensitivity to motion. Provide a voltage between 0V and 1.8V to adjust the sensitivity to meet the application requirements. A lower voltage means higher sensitivity. Typically, a simple resistor divider or trim pot is used to set the voltage.

- 1.8V = lowest sensitivity
- 0V = highest sensitivity

This signal also determines the interface mode of the Module. At power ON, and when exiting SLEEP Mode, the signal is sampled; if it is greater than 2.5V (for example, pulled to  $V_{DD}$  via resistor), then the system enters Serial Interface Mode and the pin is converted to TXD. If the signal is between 0V and 1.8V, Hardware Interface Mode is selected.

## Motion Detect

An active Low output, Pin 5 ( $\overline{MD}$ ) is activated when motion is detected. The duration in which this signal remains active is set by the DLY signal. This signal is actively driven High.

- 0 = motion detected
- 1 = no motion detected

## Light Gate

A high-impedance analog input, Pin 6 (LG), should be provided with a voltage that is proportional to the amount of ambient light in the environment (typically provided via a CDS

photocell or similar circuit). The signal is used internally to gate the  $\overline{MD}$  output signal such that it does not activate in the presence of daytime ambient light. When the voltage on this pin is lower than 1.0V, the  $\overline{MD}$  signal will not activate even when motion is detected. If  $\overline{MD}$  is in an active state when LG transitions below 1.0V, the current DLY duration is completed before  $\overline{MD}$  is deactivated. If LG is unused, connect to  $V_{DD}$ .

- GND to 1.0V =  $\overline{MD}$  does not activate when motion is detected
- 1.0V to  $V_{DD}$  =  $\overline{MD}$  is activated when motion is detected

## SLEEP Mode

Pin 7 ( $\overline{SLP}$ ) is an active Low digital input. When at logic '0', the Module enters low-power SLEEP Mode. The Module does not detect any motion and  $\overline{MD}$  is driven inactive. When SLP is at logic '1', the Module exits SLEEP Mode and begins detecting motion. This signal must be held at logic '1' during power ON.

- 0 = module disabled; low-power SLEEP Mode is active
- 1 = normal operation

## Signal Descriptions, Serial Interface Mode

This section describes the signals for operating in Serial Interface mode.

### Ground

Both Pin 1 and Pin 8 ground (GND) signals are tied together on the ZMOTION Detection Module Single Board Computer and are connected to power ground.

### Supply Voltage

The supply voltage ( $V_{DD}$ ) provides power to the Module via Pin 2. For power consumption details, see the [Electrical Characteristics](#) chapter on page 54.

### Receive Data

This Pin 3 (RXD/DLY) input is the asynchronous serial input used for sending commands and configuration to the Module. It operates at 9600 bps, no parity, 8 data bits, 1 stop bit and no flow control. For a list and description of the commands supported, see [Table 3](#) on page 14.

### Transmit Data

This Pin 4 (TXD/SNS) output is the asynchronous serial data output from the Module in response to commands and configuration supplied on the RXD line. It operates at 9600

bps, no parity, 8 data bits and 1 stop bit. For more information about the serial command interface, see the [Serial Interface Commands and Description](#) section on page 11.

This signal also determines the interface mode of the Module. At power ON, and when exiting SLEEP Mode, the signal is sampled; if it is higher than 2.5 V (for example, pulled to  $V_{DD}$  via resistor), then the system enters Serial Interface Mode. If the signal is at a value between 0 V and 1.8 V, Hardware Interface Mode is selected.

## Motion Detect and Reset

An active Low output, Pin 5 ( $\overline{MD}/\overline{RST}$ ), is activated when motion is detected. The duration in which this signal remains active is set by the DLY signal. This signal is actively driven High.

- 0 = motion detected
- 1 = no motion detected

As  $\overline{RST}$ , this pin provides an active Low hardware reset signal for the Module. The function of this pin is selected by the C serial command. The default value for this pin is  $\overline{RST}$ .

## Light Gate

A high-impedance analog input, Pin 6 (LG), is used internally to gate the  $\overline{MD}$  signal such that it does not activate in the presence of daytime ambient light. The voltage applied to this pin should be proportional to the amount of ambient light in the environment (typically provided via a CDS photocell or similar circuit).

- $LG > \text{Light Gate Threshold Register}$  —  $\overline{MD}$  is activated when motion is detected
- $LG < \text{Light Gate Threshold Register}$  —  $\overline{MD}$  does not activate when motion is detected

If  $\overline{MD}$  is in an active state when  $\overline{LG}$  transitions above the programmed value, the current DLY time is completed before  $\overline{MD}$  is deactivated.

If LG is unused, connect to  $V_{DD}$ .

## SLEEP Mode

Pin 7 ( $\overline{SLP}$ ) is an active Low digital input. When at logic 0, the Module enters low-power SLEEP Mode. The Module does not detect any motion and  $\overline{MD}$  is driven inactive. When SLP is at logic 1, the Module exits SLEEP Mode and begins detecting motion. This signal must be held at logic 1 during power ON.

- 0 = module disabled; low-power SLEEP Mode is active
- 1 = normal operation

## Voltage Brown-Out Protection and Power-On Reset

The ZMOTION Detection Module contains an internal Reset Controller with a Power-On Reset (POR) circuit and Voltage Brown-Out (VBO) protection to ensure proper operation. When power is first applied, the POR circuit monitors the supply voltage and holds the Module’s MCU in the Reset state until the supply voltage reaches a safe operating level. After the supply voltage exceeds the POR voltage threshold ( $V_{POR}$ ), the MCU is released and the Module begins operating. A further delay of typically 20 seconds is included to allow the pyroelectric sensor to stabilize. This value varies depending on environmental conditions. After this delay, the system begins to look for motion. Prior to this delay, the MD signal remains inactive.

Figure 3 displays Power-on Reset operation. See the [Electrical Characteristics](#) chapter on page 54 for the POR voltage threshold ( $V_{POR}$ ).

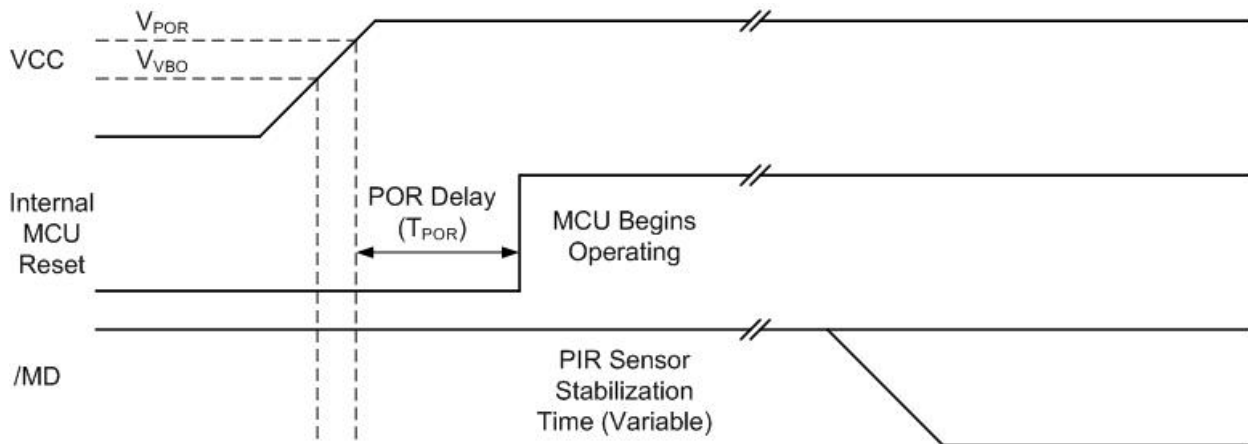

**Figure 3. Power-On Reset Operation**

The ZMOTION Detection Module provides low Voltage Brown-Out protection to ensure proper operation when the supply voltage drops below an unsafe level – below the VBO threshold voltage. The VBO circuit senses this condition and forces the Module into the Reset state. While the supply voltage remains below the POR voltage threshold ( $V_{POR}$ ), the VBO block holds the Module in the Reset.

After the supply voltage again exceeds the Power-On Reset voltage threshold, the Module progresses through a full Power-On Reset sequence, as described in the Power-On Reset section. Figure 4 displays the Voltage Brown-Out operation. See the [Electrical Characteristics](#) chapter on page 54 for the VBO voltage threshold ( $V_{VBO}$ ).

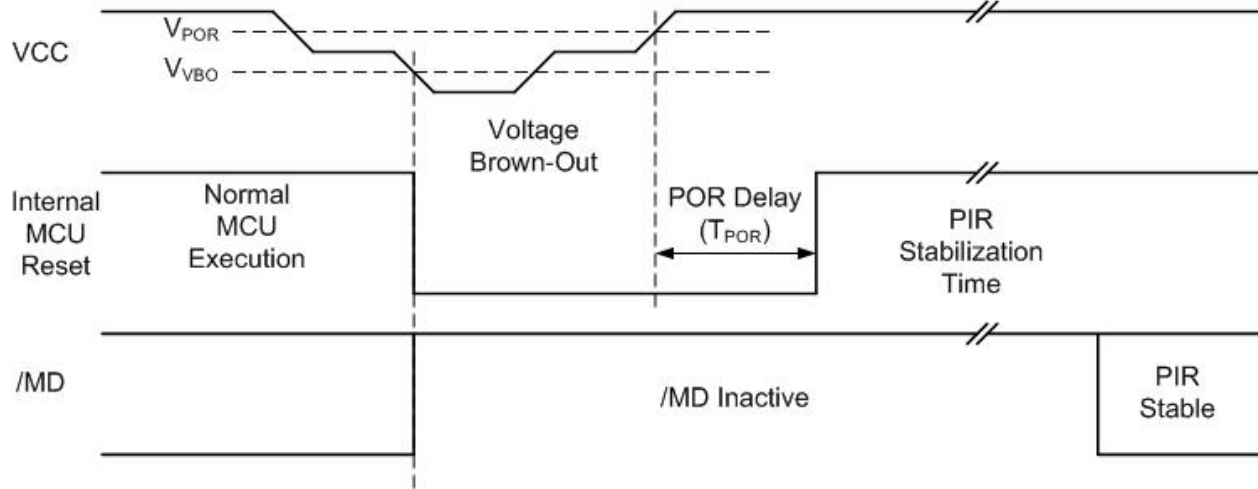

Figure 4. Voltage Brown-Out Reset Operation

## Operation

When power is applied, the TXD/SNS pin is sampled to determine the mode of operation. If the signal is above 2.5V, serial interface mode is entered. If the signal is between 0V and 1.8V hardware interface mode is entered. During this time, the pyroelectric sensor is monitored and the device waits for it to become ready. Once it is stable, the device starts normal operation in the selected mode. In hardware interface mode, the DLY, SNS, LG and  $\overline{SLP}$  signals are sampled regularly. In serial interface mode, TXD/RXD are used to communicate with the device and LG,  $\overline{SLP}$  and  $\overline{MD}$  also provide their defined functions.

## Hardware Interface Mode

This mode of operation is selected when the SNS pin is at a value between 0V and 1.8V during power ON (or after a reset caused by  $V_{BO}$ ). Once Hardware Interface mode has been established, this pin becomes the sensitivity input and accepts a voltage between 0V and 1.8V to set the motion detection sensitivity level.

- 0V = highest sensitivity
- 1.8V = lowest sensitivity

These sensitivity levels are normally achieved with a simple resistor divider or potentiometer resistor divider.



After application of power, the PIR sensor is allowed to stabilize. At this point, the MCU waits for the PIR sensor to stabilize; this period is typically 20 seconds but varies depending on environmental conditions. The software dynamically monitors the pyroelectric sensor during power up and begins detecting motion as soon as the sensor is stable.

The  $\overline{\text{MD}}$  (Motion Detect) pin is driven active (Low) when motion is detected. The duration in which the signal remains active is determined by the voltage on the delay pin and can be set to a value between 2 seconds and 15 minutes. See [Table 2](#) on page 5.

The Light Gate signal acts as a disable (gate) for the  $\overline{\text{MD}}$  signal. In a typical application, this signal is a representation of the ambient light in the environment. If there is light detected, the  $\overline{\text{MD}}$  signal does not activate, even in the presence of motion. For an example showing how to use the ZMOTION Detection Module in Hardware Interface Mode, see [Appendix A. Hardware Interface Mode](#) on page 57.

## SLEEP Mode in Hardware Interface Mode

In applications where motion detection is not always required, the Sleep signal can be used to put the device into a low power mode. The advantage of this feature vs. removing power from the Module is that the PIR stabilization time is much shorter.

If the Sleep ( $\overline{\text{SLP}}$ ) input signal is driven Low, the device enters a low power SLEEP Mode and is awakened by deactivating the signal (driving the signal High).

## Serial Interface Mode

The Serial Interface mode is implemented as a superset of the features available in Hardware interface mode. The interfacing device (Host) has an expanded feature set and more flexibility with many of those features. The interface is designed to be simple to implement on the host processor and use as few resources as possible.

This mode of operation is selected when the SNS pin is above 2.5V during power ON (or after a reset caused by  $V_{\text{BO}}$ ). Typically this signal is tied to  $V_{\text{DD}}$  through a pull-up resistor. Once Serial Interface mode has been established, this pin becomes the Transmit Data (TXD) output and is used to send responses to commands given to the device.

The serial interface is asynchronous and is set to:

- 9600 baud
- No parity
- 8 data bits
- 1 stop bit
- No flow control

In Serial Interface Mode, commands are sent to the device over the RXD input pin and responses are sent from the device over the TXD output pin. The other signals on the device ( $\overline{MD}$ , LG,  $\overline{SLP}$ ) remain active in Serial Interface mode.

Motion Detect ( $\overline{MD}$ ) output is driven active for the time set by the Output Activation Time command when motion is detected. The signal is also gated by the (Light Gate) LG input. For an example of how to use the ZMOTION Detection Module in Serial Interface Mode, see [Appendix A. Hardware Interface Mode](#) on page 57.

## SLEEP Mode in Serial Interface Mode

In applications where motion detection is not always required, the Sleep signal can be used to put the device into a low power mode. The advantage of this feature vs. removing power from the Module is that the PIR stabilization time is much shorter.

If the Sleep ( $\overline{SLP}$ ) input signal is driven Low, the device enters a low-power SLEEP Mode and is awakened by either deactivating the signal (driving the signal High) or sending a character over the serial interface; the character is received and processed.

## Serial Interface Commands and Description

The Serial Interface operates as a Host/Client relationship in which the Module is the client. Commands are sent from the Host and the Module responds with the requested information or confirmation. The only exception is when the Module is configured for  $\overline{MD}$  *Unsolicited* operation. In this mode, the Module will send *Motion Detected* information without first receiving a command from the host. All commands sent to the ZMOTION Detection Module are in ASCII character format; however, the data sent to and from the Module may be in ASCII or decimal formats.

There are three types of command structures accepted by the ZMOTION Detection Module; each is described in this section.

- Read commands
- Write commands
- Confirmation commands

### Read Command Structure

Read commands are used to request information from the ZMOTION Detection Module, and are sent from the Host. The Module responds with the requested data.

- All Read commands are initiated by single lower-case letters.
- When a Read command is received, the Module returns the applicable value, as described in the [Serial Commands](#) section on page 15. See the example in Figure 5.

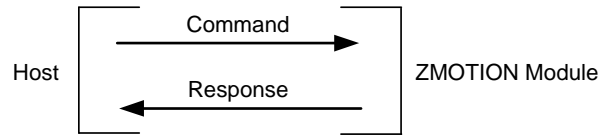

Figure 5. Read Command Structure

### Write Command Structure

Write commands are used to update the configuration of the ZMOTION Detection Module, and are sent from the Host. The Module responds with the current value as an acknowledgment. The Host then sends the new data and the Module responds with an ACK.

- All write commands are initiated by single upper-case letters.
- After a write command is received, the device returns the current value and expects an appropriate single-byte data value.
- When the data value is received, the device returns an ACK. If no data is received after the inactivity time-out period of 2.5 seconds, the device returns a NACK. See the example in Figure 6.

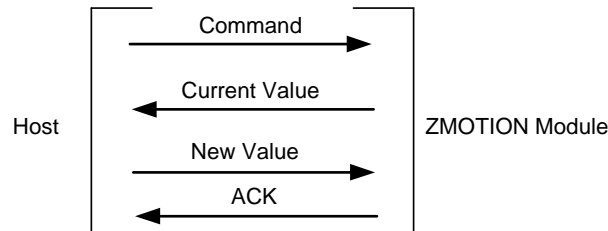

Figure 6. Write Command Structure

### Confirmed Command Structure

Certain commands require a specific sequence of characters to be sent to prevent accidental initiation. These commands require a 4-character confirmation sequence. After a command requiring confirmation is received, the device returns an ACK.

- If the sequence is correct, the device returns an ACK and executes the command.
- If the sequence is incorrect, or if there is an inactivity delay of more than 2.5 seconds between any characters of the sequence, the device immediately sends a NACK and does not execute the command. See the example in Figure 7.

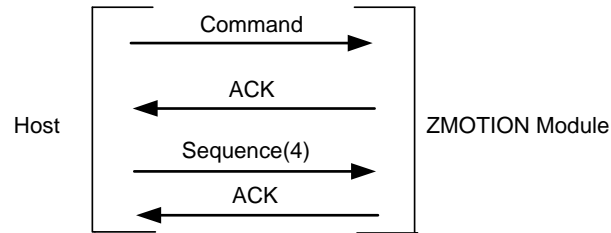

Figure 7. Confirmed Command Structure

---

► **Notes:** ACK = 0x06 (ASCII ACK character).

NACK = 0x15 (ASCII NACK character). The Module will respond with a NACK on all unrecognized commands, and when commands requiring data (that is, Write, Clear, and Confirmation types) do not receive the required data within the inactivity time-out period.

---

Table 3. Summary of Serial Interface Commands

Command	Name	Value [Default]	Command	Name	Value [Default]
0x43-'C'	Write MD/RST Pin Configuration	'M', 'R'	0x64-'d'	Read MD Activation Time	0-255 [2]
0x44-'D'	Write MD Activation Time	0-255	0x65-'e'	Read Hyper Sense Setting	'Y', 'N' [N]
0x45-'E'	Write Hyper Sense Setting	'Y', 'N'	0x66-'f'	Read Frequency Response Setting	'H', 'L' [L]
0x46-'F'	Write Frequency Response Setting	'H', 'L'	0x67-'g'	Read Hyper Sense Level	0-3 [1]
0x47-'G'	Write Hyper Sense Level	0-3	0x68-'h'	Read Motion Detection Suspend Setting	'Y', 'N' [N]
0x48-'H'	Write Motion Detection Suspend Setting	'Y', 'N'	0x69-'i'	Read Module Software Revision	0-255, 0-255 [6,4]
0x4B-'K'	Write Serial Interface Command Mode	'D', 'A'	0x6B-'k'	Read Serial Interface Command Mode	'D', 'A' [D]
0x4C-'L'	Write Light Gate Threshold	0-255	0x6C-'l'	Read Light Gate Threshold	0-255 [100]
0x4F-'O'	Write MD Output State	0-255	0x6D-'m'	Read Motion Detected Unsolicited Mode	'Y', 'N' [N]
0x50-'P'	Write Ping Value	0-255	0x4D-'M'	Write Motion Detected Unsolicited Mode	'Y', 'N'
0x52-'R'	Write Range Setting	0-7	0x6F-'o'	Read MD Current Output Active Time	0-255 [0]
0x53-'S'	Write Sensitivity	0-255	0x70-'p'	Read Ping Value	0-255 [1]
0x55-'U'	Write Dual Directional Mode	'Y', 'N'	0x72-'r'	Read Range Setting	0-7 [2]
0x58-'X'	Module Reset	'1', '2', '3', '4'	0x73-'s'	Read Sensitivity	0-255 [16]
0x59-'Y'	Write Sleep Time	0-255	0x75-'u'	Read Dual Directional Mode	'Y', 'N' [N]
0x5A-'Z'	SLEEP Mode	'1', '2', '3', '4'	0x76-'v'	Read Single Directional Mode	'A', '+', '-' [A]
0x61-'a'	Read Motion Status	'Y', 'N', 'U'	0x56-'V'	Write Single Directional Mode	'A', '+', '-'
0x62-'b'	Read Current Light Gate Input Level	0-255	0x79-'y'	Read Sleep Time	0-255 [0]
0x63-'c'	Read MD/RST Pin Configuration	'M', 'R' [R]			

## Serial Commands

The Serial Interface commands summarized in Table 3 are each described in this section.

### Motion Status Command

The current status of detected motion can be read and cleared through this command. When motion has been detected the value is set to 'Y' and latched until read with the 'a' command. Once cleared, the status remains at 'N' until motion is again detected.

#### *Read Motion Status*

##### Command

'a' (0x61)

##### Description

The Read Motion Status command returns the current status of detected motion. The current status is set to 'N' when read.

##### Return Values

'Y' = Motion detected

'N' = No motion detected

'U' = PIR Sensor has not stabilized after power-up

##### Normal Command Sequence

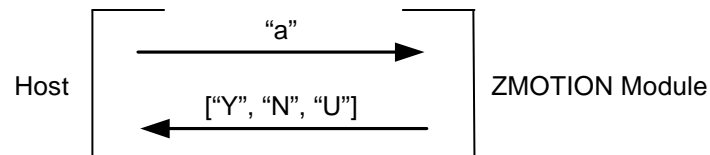

---

► **Note:** The returned value ('Y', 'N', 'U') is independent of the  $\overline{MD}$  output state or the  $\overline{MD}$  Activation Time (see commands 'o'/'O' and 'd'/'D').

---

## Light Gate Level Commands

Light Gate Level commands control and monitor the signal associated with the Light Gate (LG) pin, and they are typically relative to the ambient light detected by an externally connected CDS photocell. The range is 0 to 255, with 0 indicating maximum ambient light and, 255 indicating minimum ambient light. See [Appendix A. Hardware Interface Mode](#) on page 57 and [Appendix B. Serial Interface Mode](#) on page 58 for recommended CDS photocell connections. The 'b' command reads the current signal level present on the pin.

The 'L' command sets the Light Gate Threshold value. This value is used in conjunction with the signal on the LG pin to internally gate the  $\overline{MD}$  signal such that it does not activate in the presence of ambient light. When the signal on the Light Gate (LG) pin is below this value, the  $\overline{MD}$  output signal remains inactive even when motion has been detected. When the signal on the Light Gate (LG) pin is above this value, the  $\overline{MD}$  signal activates normally when motion has been detected.

Table 4 lists the pages in this section that describe their respective commands.

**Table 4. Shortcuts to Light Gate Level Commands**

Name	Command	Page
Read Current Light Gate Input Level	'b' (0x62)	<a href="#">16</a>
Read Light Gate Threshold	'l' (0x6C)	<a href="#">17</a>
Write Light Gate Threshold	'L' (0x4C)	<a href="#">17</a>

### *Read Current Light Gate Input Level*

#### Command

'b' (0x62)

#### Description

The 'b' command returns the current signal level present on the Light Gate (LG) pin.

#### Return Values

0–255 (decimal)

#### Normal Command Sequence

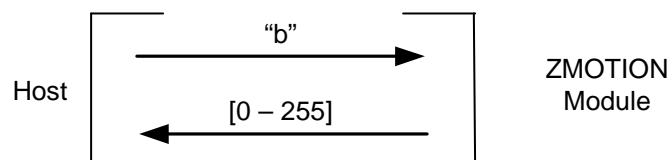

## Read Light Gate Threshold

### Command

'1' (0x6C)

### Description

The '1' command returns the current Light Gate threshold value set by the Write Light Gate Threshold command.

### Return Values

0-255 (decimal)

### Normal Command Sequence

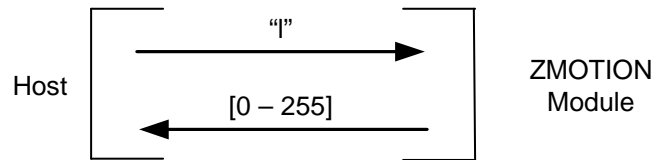

## Write Light Gate Threshold

### Command

'L' (0x4C)

### Description

The 'L' command sets the Light Gate Threshold value.

### Input Values

0-255 (decimal)

### Normal Command Sequence

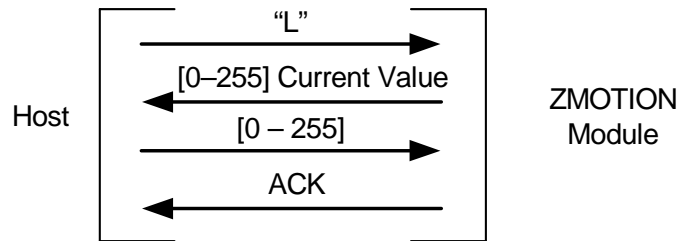



## $\overline{\text{MD}}/\overline{\text{RST}}$ Pin Configuration

The  $\overline{\text{MD}}/\overline{\text{RST}}$  pin can be configured to function as either the Motion Detect output or the Reset input. This command selects between the two modes. As  $\overline{\text{RST}}$ , a Low on this pin causes the Module to perform a full hardware reset. See [Signal Descriptions, Serial Interface Mode](#) on page 6 for more information.

### Read $\overline{\text{MD}}/\overline{\text{RST}}$ Pin Configuration

#### Command

'c' (0x63)

#### Description

This Read command returns the configuration mode of the  $\overline{\text{MD}}/\overline{\text{RST}}$  pin as set by the 'C' command.

#### Return Values

'M' =  $\overline{\text{MD}}/\overline{\text{RST}}$  pin configured as  $\overline{\text{MD}}$

'R' =  $\overline{\text{MD}}/\overline{\text{RST}}$  pin configured as  $\overline{\text{RST}}$

#### Normal Command Sequence

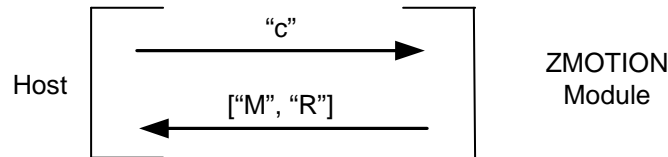

### Write $\overline{\text{MD}}/\overline{\text{RST}}$ Pin Configuration

#### Command

'C' (0x43)

#### Description

Configures the  $\overline{\text{MD}}/\overline{\text{RST}}$  pin as either Motion Detect output ( $\overline{\text{MD}}$ ) or Module Reset ( $\overline{\text{RST}}$ ).

#### Input Values

'M' = Configure  $\overline{\text{MD}}/\overline{\text{RST}}$  pin as  $\overline{\text{MD}}$

'R' = Configure  $\overline{\text{MD}}/\overline{\text{RST}}$  pin as  $\overline{\text{RST}}$

Normal Command Sequence

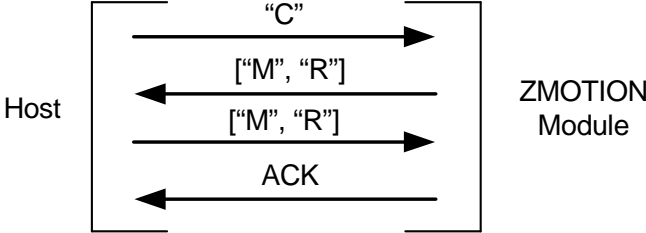

## $\overline{\text{MD}}$ Activation Time

The duration in which the  $\overline{\text{MD}}$  pin is held active when motion is detected is configured by this command. See Table 5 for corresponding values.

**Table 5.  $\overline{\text{MD}}$  Output Activation Time Values**

Command Value	$\overline{\text{MD}}$ Output Activation Time
0	Output does not activate upon motion.
1–127	1–127 seconds.
128	Output does not activate upon motion.
129–255	1–128 minutes.

### *Read MD Activation Time*

#### Command

'd' (0x64)

#### Description

Returns the  $\overline{\text{MD}}$  pin output activation time value used when motion is detected.

#### Return Values

0–255 (decimal); see Table 5.

#### Normal Command Sequence

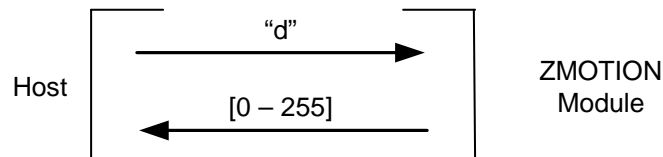

### *Write MD Activation Time*

#### Command

'D' (0x44)

#### Description

Selects the  $\overline{\text{MD}}$  pin output activation time value used when motion is detected.

### Input Values

0–255 (decimal); see Table 5.

### Normal Command Sequence

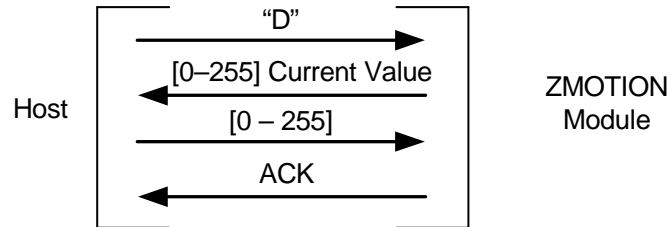

### Hyper Sense

Hyper Sense Mode allows smaller signal changes to be considered valid motion events. This mode significantly increases sensitivity at the cost of more potential false motion detections. The typical application for this mode is in occupancy sensing where it is enabled after valid 'normal' motion has already been detected.

### *Read Hyper Sense Setting*

#### Command

'e' (0x65)

#### Description

This command returns the current status of the Hyper Sense setting.

#### Return Values

'Y' = Hyper Sense Enabled

'N' = Hyper Sense Disabled

### Normal Command Sequence

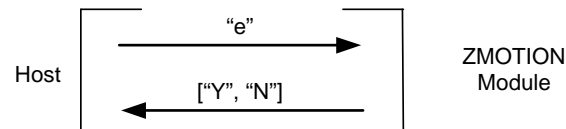

### Write Hyper Sense Setting

#### Command

'E' (0x45)

#### Description

This command enables and disables Hyper Sense mode.

#### Input Values

'Y' = Hyper Sense Enabled

'N' = Hyper Sense Disabled

#### Normal Command Sequence

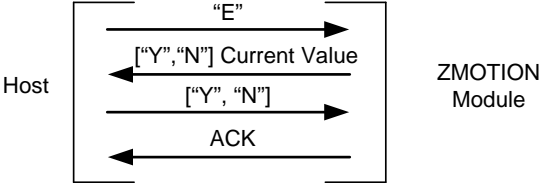

## Hyper Sense Level Setting

This command defines the Hyper Sense sensitivity level when the mode is enabled via the 'E' command. The purpose of the Hyper Sense mode is to increase the detectors sensitivity to more subtle motion events. A value of 0 to 3 is used to set the level. Setting the level to 0 has the same effect as disabling Hyper Sense with the 'E' command (setting it to 'N'). Setting it to any other level can cause the occasional false detection, so this mode should only be used when the occasional false detection is tolerable.

### *Read Hyper Sense Level Setting*

#### Command

'g' (0x67)

#### Description

This command returns the current Hyper Sense level that will be used when the Hyper Sense mode is enabled via the 'E' command. 0 is the lowest setting and corresponds to off, while 3 is the most sensitive setting.

#### Return Values

0-3 (decimal)

#### Normal Command Sequence

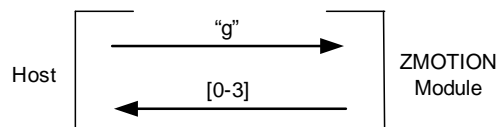

### *Write Hyper Sense Level Setting*

#### Command

'G' (0x47)

#### Description

This command sets the Hyper Sense level used when it is enabled via the 'E' command. If Hyper Sense is currently on ('E' set to 'Y') when a new level is written, the new level is automatically used.

**Input Values**

0-3 (decimal)

**Normal Command Sequence**

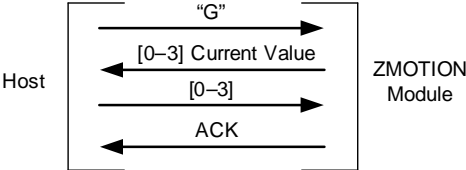

## Frequency Response Setting

The Frequency Response setting controls sensitivity to targets producing lower frequencies. When set to 'H', sensitivity to targets producing lower frequencies is reduced. This reduced sensitivity also has the effect of reducing the distance over which the ZMOTION Detection Module can detect motion.

### *Read Frequency Response Setting*

#### Command

'f' (0x66)

#### Description

This command returns the current frequency response setting of the Module.

#### Return Values

L = low and high frequency targets detected

H = low frequency target sensitivity reduced

#### Normal Command Sequence

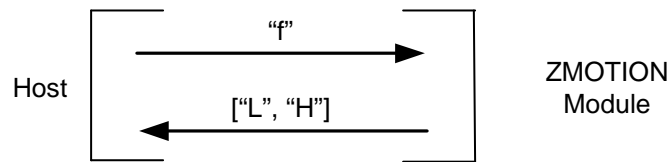

### *Write Frequency Response Setting*

#### Command

'F' (0x46)

#### Description

This command sets the Frequency Response of the Module.

#### Input Values

L = low and high frequency targets detected

H = low frequency target sensitivity reduced



Normal Command Sequence

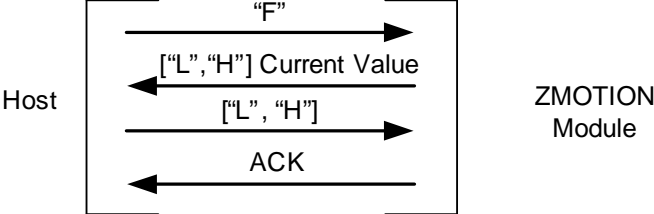

## Motion Detection Suspend

This command enables and disables motion detection by the ZMOTION Detection Module. When set to 'N', the Module detects motion. When set to 'Y', motion detection is suspended. While Motion Detection Suspend is a method to temporarily disable motion detection, the MD pin may still be *manually* driven active/inactive via the 'O' (Write MD Output State) command.

### *Read Motion Detection Suspend Setting*

#### Command

'h' (0x68)

#### Description

This read command returns the current Motion Detection Suspend setting.

#### Return Values

Y = Motion Detection is suspended

N = Motion Detection is active

#### Normal Command Sequence

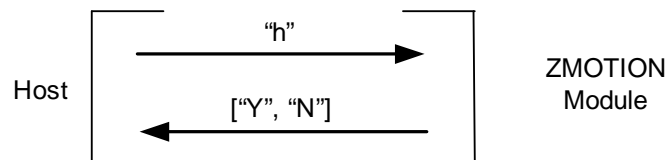

### *Write Motion Detection Suspend Setting*

#### Command

'H' (0x48)

#### Description

This write command enables and disables motion detection by the ZMOTION Detection Module.

#### Input Values

Y = Motion detection is suspended

N = Motion detection is active

**Normal Command Sequence**

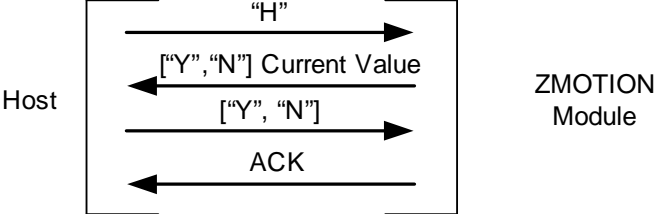

## Software Revision

The software in the ZMOTION Detection Module is made up of two parts:

- Advanced passive infrared software engine
- Application software

The S/W Revision command returns the revisions of this software.

The advanced passive infrared software engine is locked into the device and cannot be changed. This software provides all of the algorithms and processing functions required for motion detection—Refer to product specification for the Z8FS040 ZMOTION MCU for more details on the operation of this software.

The application software provides the Serial and H/W Interface Mode functionality. It uses the services provided by the advanced passive infrared software engine for all of the motion detection functions. This application software is available for download and can be modified for custom applications. Please see the Zilog Web Site to obtain the application software project.

See [Appendix C. Software Revisions](#) on page 59 for version information.

### Software Revision

#### Command

'i' (0x69)

#### Description

The 'i' command returns the revision of the software programmed into the ZMOTION Detection Module. The first value returned is the application software revision. The second value returned is the advanced passive infrared software engine revision. See [Table 13](#) and [Table 14](#) in Appendix C for a description of software revisions.

#### Return Values

VAL1 = 0–255 (decimal); Application Software Version

VAL2 = 0–255 (decimal); ZMOTION Software Engine Version

#### Normal Command Sequence

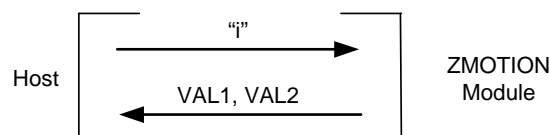

## Serial Interface Command Mode

The serial interface can operate in either ASCII or ASCII/Decimal modes. The default is ASCII/Decimal where commands are sent as ASCII characters, but numeric values sent and returned are decimal. In ASCII mode, all commands and numeric values are sent and returned in ASCII, which is useful for demonstration purposes or when using a terminal to control and monitor the ZMOTION Detection Module (see Table 6).

For example, the data for the Sensitivity command is a value from 0 to 255. In ASCII/Decimal mode, this data would be sent as a single byte (0x00 to 0xFF). In ASCII mode, this data would be sent as 3 bytes: '0','0','0' to '2','5','5'. All values are sent as 3 characters.

**Table 6. MD Output Activation Time Values**

Command Value	MD Output Activation Time
0	Output does not activate upon motion.
1–127	1–127 seconds.
128	Output does not activate upon motion.
129–255	1–128 minutes.

### Read Serial Interface Command Mode

#### Command

'k' (0x6B)

#### Description

This command returns the current command interface mode.

#### Return Values

'A' = ASCII Mode enabled

'D' = ASCII/Decimal Mode enabled (default)

#### Normal Command Sequence

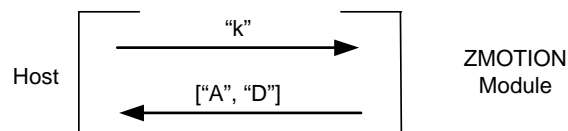

### Write Serial Interface Command Mode

#### Command

"K" (0x4B)

#### Description

This command selects the command interface mode.

#### Input Values

'A' = ASCII Mode enabled

'D' = ASCII/Decimal Mode enabled

#### Normal Command Sequence

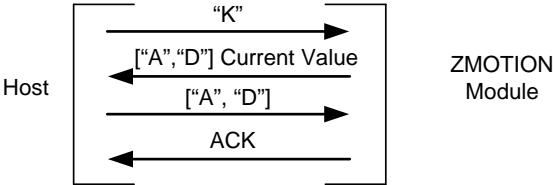

## Motion Detected Unsolicited Mode

This mode allows the ZMOTION Detection Module to send motion detection status to the Host unsolicited (without first sending the 'a' command). The Module will send an 'M' to the Host every time motion is detected. When Unsolicited mode is not used, the Host must poll the Module using the 'a' command or read the Current Output Active Time using the 'o' to determine motion detection status.

### *Read Motion Detected Unsolicited Mode*

#### Command

'm' (0x6D)

#### Description

This read command returns the Motion Detected Unsolicited Mode currently selected.

#### Return Values

'Y' = Unsolicited Mode is enabled; the Module sends an 'M' each time motion is detected.

'N' = Unsolicited Mode is disabled.

#### Normal Command Sequence

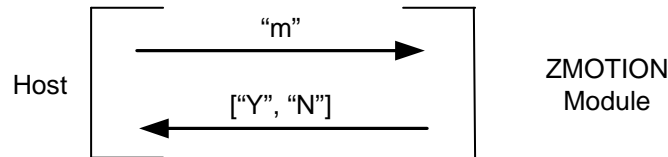

### *Write Motion Detected Unsolicited Mode*

#### Command

'M' (0x4D)

#### Description

Enable/disable Motion Detected Unsolicited Mode.

#### Input Values

'Y' = Unsolicited Mode is enabled; the Module sends an 'M' each time motion is detected.

'N' = Unsolicited Mode is disabled.

Normal Command Sequence

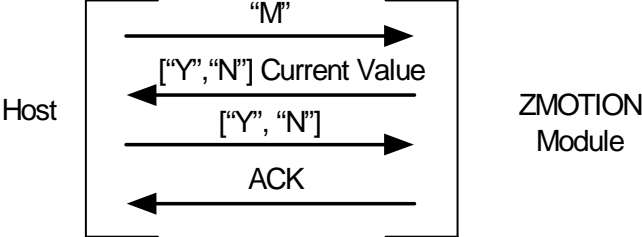



## $\overline{\text{MD}}$ Current Active Output Time

This command directly controls the  $\overline{\text{MD}}$  output pin. The ‘O’ command activates the  $\overline{\text{MD}}$  output pin for the amount of time specified in the command; it is a manual override of the current state of  $\overline{\text{MD}}$  and is independent of motion detection. The valid range is listed in Table 7. The ‘o’ command is used to read the remaining time in which  $\overline{\text{MD}}$  will be held active—as initiated by this command or by detected motion. If motion is detected after the ‘O’ command is given, the  $\overline{\text{MD}}$  output time restarts at the  $\overline{\text{MD}}$  Activation Time set by the ‘D’ command.

Table 7.  $\overline{\text{MD}}$  Output Activation Time Values

Command Value	$\overline{\text{MD}}$ Output Activation Time
0	Output does not activate upon motion.
1–127	1–127 seconds.
128	Output does not activate upon motion.
129–255	1–128 minutes.

## Read $\overline{\text{MD}}$ Current Output Active Time

### Command

‘o’ (0x6F)

### Description

Returns the remaining time in which the  $\overline{\text{MD}}$  output pin will be held active.

### Return Values

0–255 (decimal); see Table 7.

### Normal Command Sequence

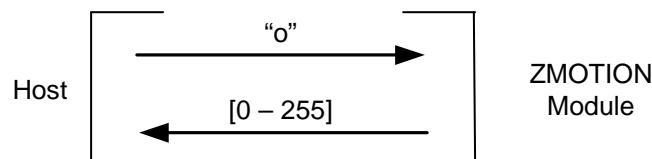

► **Note:** This command is still valid if the  $\overline{\text{MD}}$  pin is configured for  $\overline{\text{RST}}$ . The command returns the state of  $\overline{\text{MD}}$  pin as if it was configured to indicate motion.

## Write $\overline{MD}$ Output State

### Command

'O' (0x4F)

### Description

Activates the  $\overline{MD}$  output pin for the duration of activation time required.

### Input Values

0–255 (decimal);  $\overline{MD}$  activated for a selected duration of time; see [Table 7](#).

### Normal Command Sequence

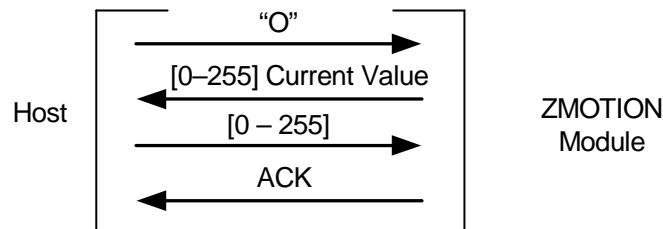

- 
- **Notes:** This command does not affect the Read Motion Status command ('a') or the Clear Motion Status command ('A').

If the  $\overline{MD}$  pin is configured as Reset, the value is saved as if the  $\overline{MD}$  pin is configured to indicate motion.

---

## Ping

This command provides a simple method to ping the ZMOTION Detection Module to ensure it is responding to commands. The ‘P’ command writes a value (typically a 1 or a 2) that can be read back using the ‘p’ command. The ‘P’ command only accepts a single written character whether it is in ASCII mode or ASCII/Decimal mode (‘K’ command). For example, sending the command ‘P’, ‘1’ will return ‘0’, ‘4’, ‘9’ in ASCII mode and 0x31 (49 decimal) in ASCII/Decimal mode.

### *Read Ping Value*

#### Command

‘p’ (0x70)

#### Description

This command returns the last written Ping value.

#### Return Values

Last value written using the ‘P’ command. The default value is 1.

#### Normal Command Sequence

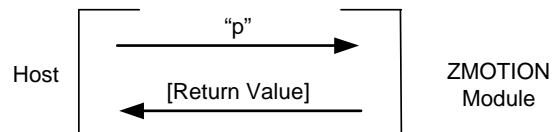

### *Write Ping Value*

#### Command

‘P’ (0x50)

#### Description

This write command stores a value that can be read by the ‘p’ command.

#### Input Values

0–255 (decimal); a value is stored and read by the ‘p’ command.

Normal Command Sequence

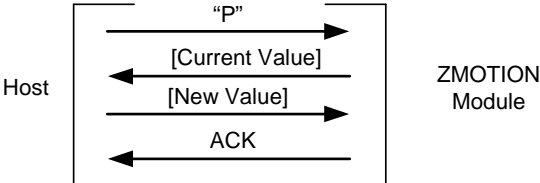

## Range Setting

This command determines the relative range of motion detection. Larger values decrease the range of detection. Range is also dependent on target size, speed and relative temperature. For example, a range control setting that rejects one target of a particular size at a given distance does not guarantee that a larger target will be rejected at the same distance.

### *Read Range Setting*

#### Command

'r' (0x72)

#### Description

This command returns the current range setting.

#### Return Values

0-7 (decimal)

#### Normal Command Sequence

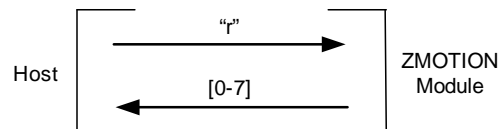

### *Write Range Setting*

#### Command

'R' (0x52)

#### Description

This command sets the Range value.

#### Input Values

0-7 (decimal)

**Normal Command Sequence**

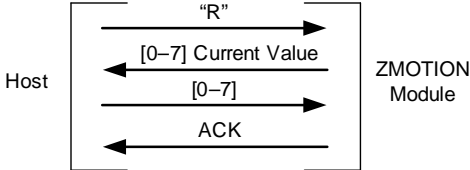

## Sensitivity

This command controls how sensitive the ZMOTION Detection Module is to motion. Larger values provide lower sensitivity and also have the effect of reducing the range. Smaller values provide higher sensitivity.

### *Read Sensitivity*

#### Command

`'s'` (0x73)

#### Description

This command returns the current motion detection sensitivity setting.

#### Return Values

0–255 (decimal)

#### Normal Command Sequence

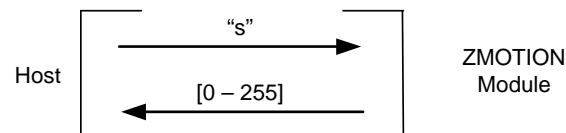

### *Write Sensitivity*

#### Command

`'S'` (0x53)

#### Description

This command sets the motion detection sensitivity.

#### Input Values

0–255 (decimal)

Normal Command Sequence

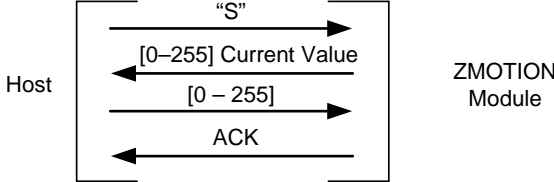



## Directional Detection

Directional Detection places the ZMOTION Detection Module in a mode that detects both positive and negative motion directions. When Dual Direction Mode is enabled via the 'U' command, motion is detected in either direction and the 'a' and 'M' commands are enhanced to respond with a '+' or '-' to indicate the direction of the motion target. Single Direction Mode is enabled via the 'V' command and is similar to the 'U' command except motion is detected in only one of the '+' or '-' directions as set when the 'V' command is issued. The 'a' and 'M' commands are not modified when in Single Direction Mode.

The signal generated by the pyroelectric sensor used to discern direction can vary from device to device, but is consistent for a particular device. Therefore, the '+' and '-' direction settings can mean either left to right or right to left motion, but will always be the same for that particular device. Each device can be calibrated simply by creating motion in one or both directions and observing the results. Other factors such as where the target starts motion will affect the directional detection capabilities of the ZMOTION Detection Module. Directional detection works best when the target moves horizontally starting from outside of the range (left or right side) of Module and through the beams of the detection pattern. If the target begins motion while inside the Module detection pattern area, an incorrect direction can be reported.

Table 8 lists the pages in this section that describe their respective commands.

**Table 8. Shortcuts to Directional Detection Commands**

Name	Command	Page
Read Dual Direction Mode	'u' (0x75)	<a href="#">42</a>
Write Dual Direction Mode	'U' (0x55)	<a href="#">43</a>
Read Single Direction Mode	'v' (0x76)	<a href="#">43</a>
Write Single Direction Mode	'V' (0x56)	<a href="#">44</a>

### ***Read Dual Direction Mode***

#### **Command**

'u' (0x75)

#### **Description**

The 'u' command returns the current Dual Direction Mode setting.

#### **Return Values**

'N' = Dual Direction Mode disabled.

'Y' = Dual Direction Mode enabled.

### Normal Command Sequence

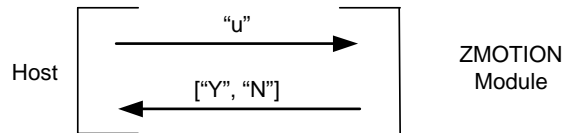

### Write Dual Direction Mode

#### Command

'U' (0x55)

#### Description

Enable directional detection in both '+' and '-' directions.

When Dual Direction mode is enabled, the 'a' command (Read Motion Status) and 'M' command (Motion Detected Unsolicited Mode) provide the directional information:

'+' = Motion detected in the '+' direction.

'-' = Motion detected in the '-' direction.

#### Input Values

'N' = Dual Direction Mode disabled.

'Y' = Dual Direction Mode enabled.

### Normal Command Sequence

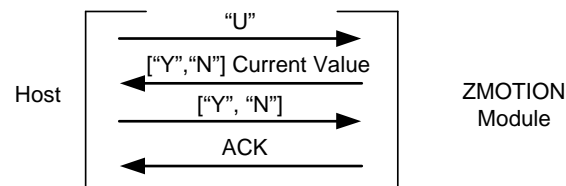

### Read Single Direction Mode

#### Command

'v' (0x76)

#### Description

The 'v' command returns the current setting of the Single Direction Mode.

### Return Values

'A' = Single Direction Mode disabled.

'+' = Single direction mode set to detect motion only in the '+' direction.

'-' = Single direction mode set to detect motion only in the '-' direction.

### Normal Command Sequence

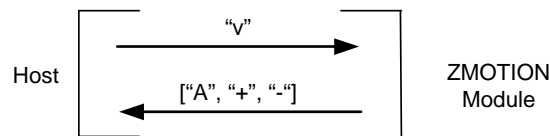

### Write Single Direction Mode

#### Command

'V' (0x56)

#### Description

The 'V' command selects the direction of motion to be detected. When Single Direction Mode is enabled, motion status is reported only when motion is detected in the direction specified. For example, if the '+' direction is specified, then the 'a' command (Read Motion Status) will return a 'Y' only when motion is detected in the '+' direction. If motion is detected in the '-' direction, the 'a' command would return 'N'.

#### Input Values

'A' = Single Direction Mode disabled.

'+' = Detect motion only in the '+' direction.

'-' = Detect motion only in the '-' direction.

### Normal Command Sequence

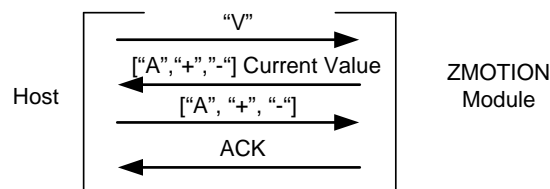

## Module Reset

This command forces the ZMOTION Detection Module to perform a reset. All configuration and status are returned to default values; see [Table 3](#) on page 14.

This is a special command that requires confirmation. After 'X' is received, the Module sends an ACK and expects the 4-digit confirmation sequence (1, 2, 3, 4).

Once this sequence is received the device sends an 'ACK' and performs a reset. If the confirm sequence is incorrect or the inactivity time-out is exceeded, the device will send a 'NACK' and ignore the reset request.

Table 9 lists the pages in this section that describe their respective commands.

**Table 9. Shortcuts to Module Reset Commands**

Name	Command	Page
Module Reset	'X' (0x58)	<a href="#">45</a>
Read Sleep Time	'y' (0x79)	<a href="#">46</a>
Write Sleep Time	'Y' (0x79)	<a href="#">46</a>

### Module Reset

#### Command

'X' (0x58)

#### Description

Reset the ZMOTION Detection Module.

#### Return Values

ACK = Reset command accepted.

NACK = Reset command not accepted.

#### Normal Command Sequence

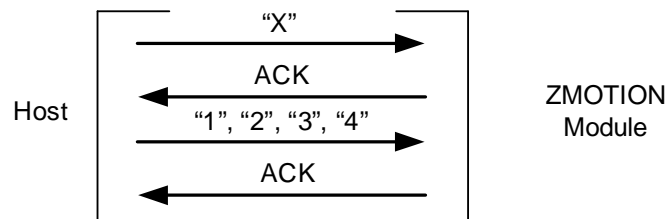

## Read Sleep Time

### Command

'Y' (0x79)

### Description

This command returns the current sleep time setting in seconds.

### Return Values

0-255 (decimal)

### Normal Command Sequence

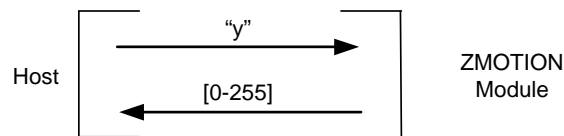

## Write Sleep Time

### Command

'Y' (0x79)

### Description

This command sets the Sleep duration in seconds. A value of 0 disables the sleep timer, and wake-up is initiated only by a transition on the SLP pin or when a character is received over the serial interface (i.e., the character is received and processed).

### Input Values

0-255 (decimal)

### Normal Command Sequence

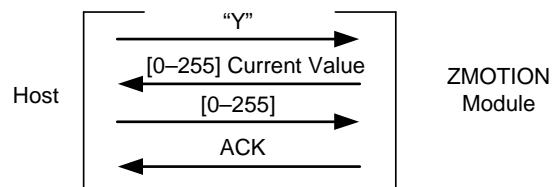

## Sleep Mode

This command places ZMOTION Detection Module into SLEEP Mode. SLEEP Mode Enable is a special command that requires confirmation. After the 'Z' is received, the Module sends an ACK and expects the 4-digit confirmation sequence (1, 2, 3, 4). After this sequence is received, the device sends an ACK and enters low power SLEEP Mode for the number of seconds set by the 'Y' (Write Sleep Time) command. If the confirm sequence is incorrect or the inactivity time-out is exceeded, the device will send a NACK and ignore the reset request.

Sleep Mode is exited automatically when the sleep time expires or by a transition on the SLP pin or by sending a character over the serial interface—this character is ignored. A value of 0 for sleep time disables the sleep timer.

### *Sleep Mode Enable*

#### Command

'Z' (0x5A)

#### Description

The 'Z' command places the ZMOTION Detection Module into low-power Sleep Mode.

#### Return Values

ACK = Sleep command accepted.

NACK = Sleep command not accepted.

#### Normal Command Sequence

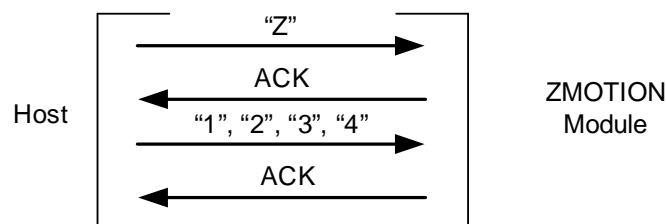

## Detection Pattern

The Fresnel lens directs the infrared energy from the target on to the pyroelectric sensor. Figure 8 shows the coverage area provided by the ZMOTION Detection Module. It provides a 60-degree cone with 4 beams; the two inner beams provide greater range than the two outer beams. The actual range is affected by ambient temperature and the settings provided to the Module; Sensitivity, Range, Hyper Sense and Frequency Response all contribute to the range performance.

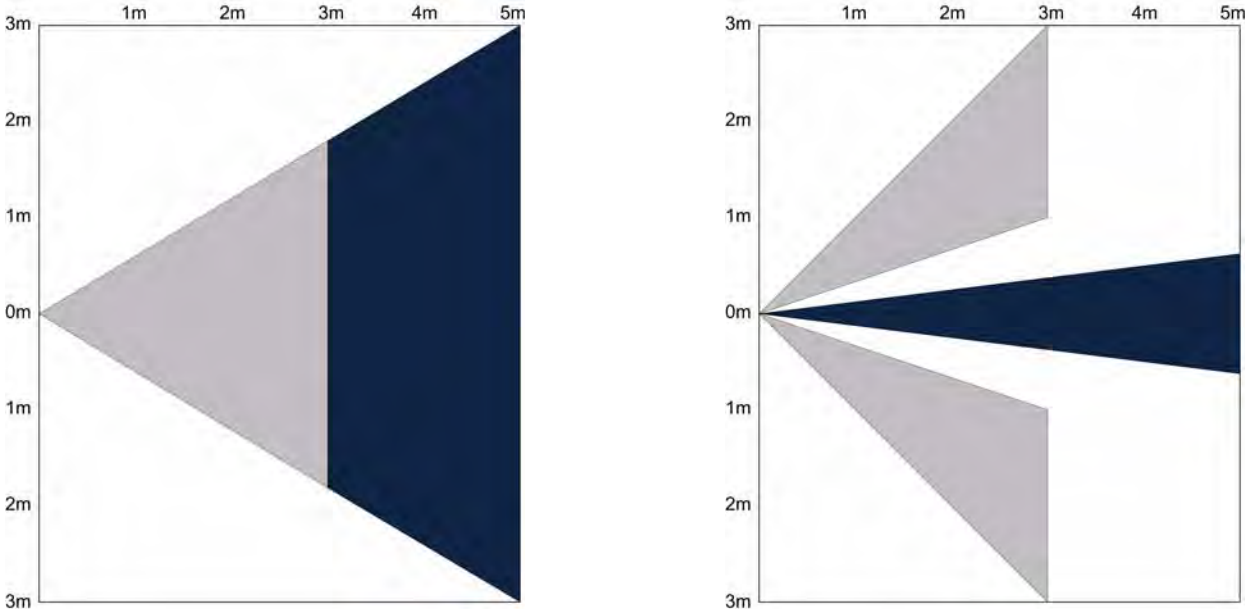

Figure 8. Detection Pattern

### Mechanical Information

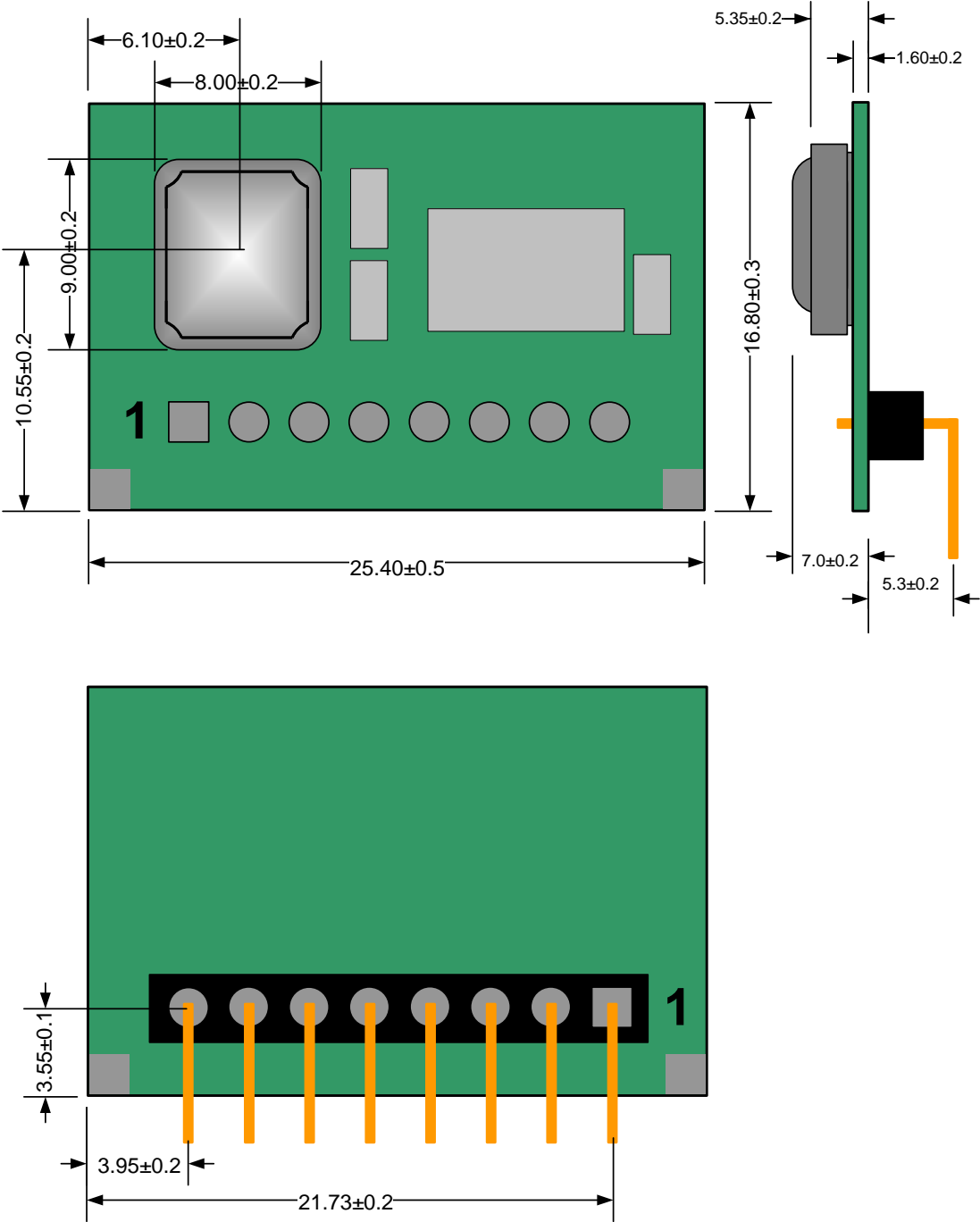
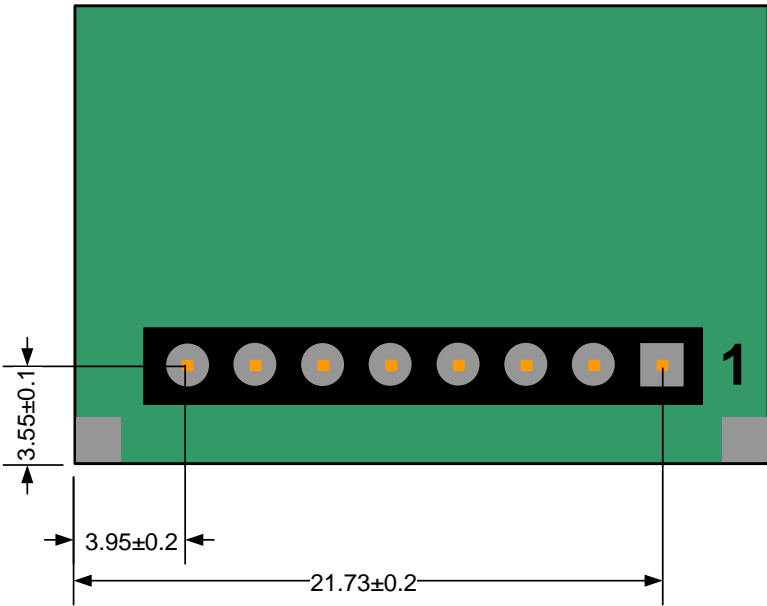
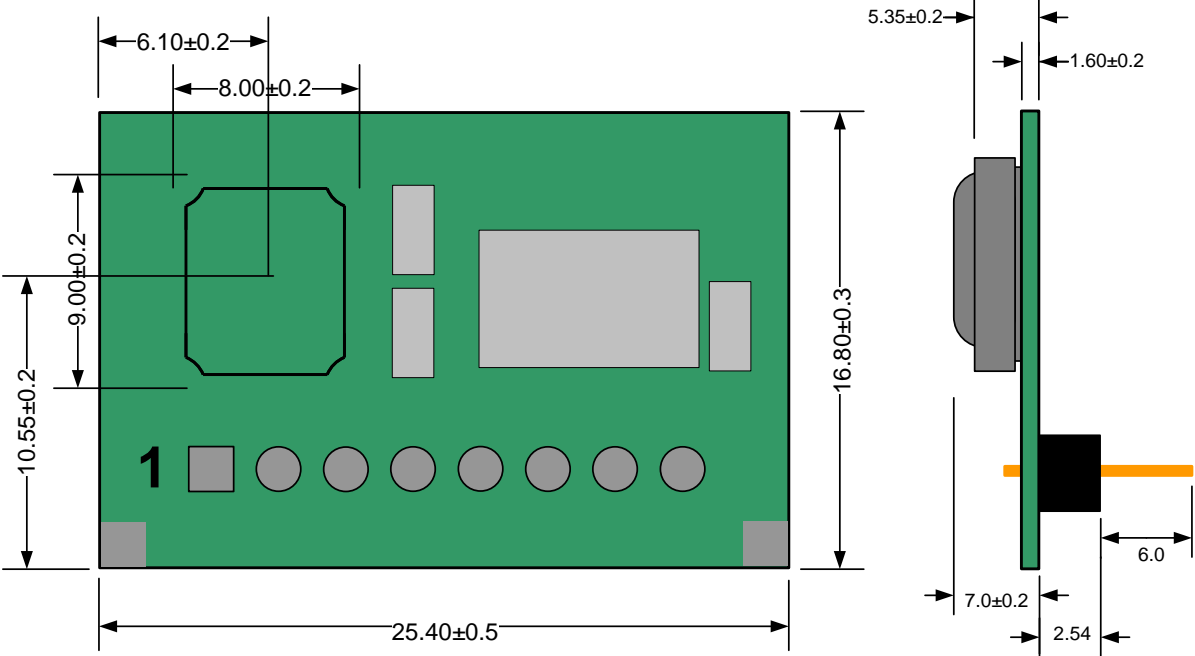

Figure 9. Mechanical Drawing of the ZMOTION Detection Module (ZEPIR0AAS02MODG)





Note: All dimensions in mm

Figure 10. Mechanical Drawing of the ZMOTION Detection Module (ZEPIR0ABS02MODG)

# ZMOTION Detection Module Schematic

Figure 11 displays a schematic representation of the ZMOTION Detection Module.

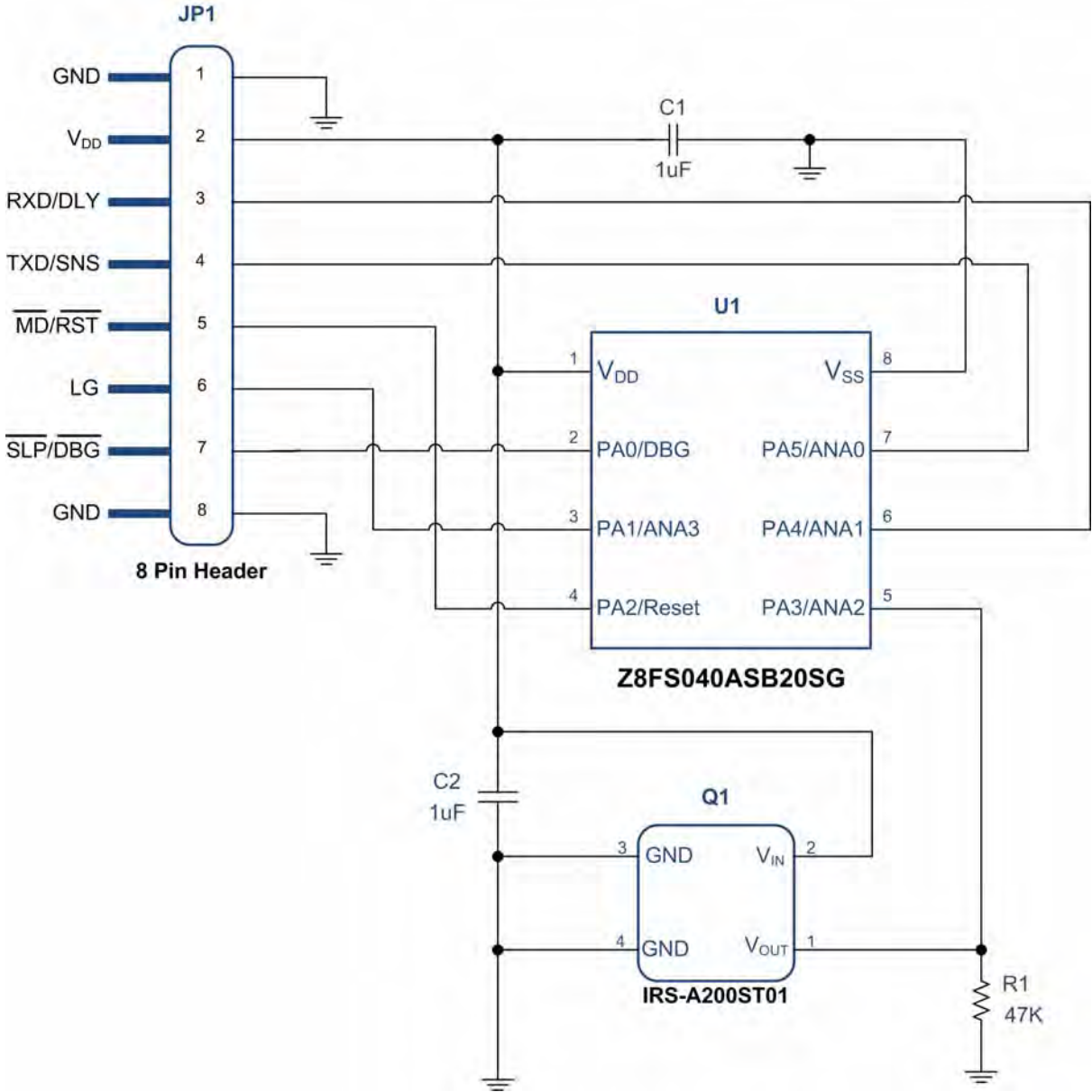

Figure 11. Schematic of ZMOTION Detection Module

## Related Documents

Additional information related to the ZMOTION Detection Module can be found in the following documents.

- Z8 Encore! XP<sup>®</sup> F082A Series Product Specification (PS0228)
- ZMOTION Detection Module Product Brief (PB0223)
- ZMOTION Detection Module Development Kit Quick Start Guide (QS0073)
- ZMOTION Detection Module Development Kit User Manual (UM0223)
- ZMOTION Detection Module Application Walkthrough (AN0307)
- ZMOTION: A New PIR Motion Detection Architecture White Paper (WP0017)
- Power Management and Customer Sensing with Zilog's ZMOTION Detection Module (AN0301)
- ZMOTION Detection and Control Family Featuring PIR Technology Product Specification (PS0285)

## Related Products

The table below lists the products related with ZMOTION Detection Module.

Product Number	Product Description
Z8FS040BSB20EG	ZMOTION MCU (8 pin SOIC)*
Z8FS040BHH20EG	ZMOTION MCU (20 pin SOIC)*
Z8FS040BHJ20EG	ZMOTION MCU (28 pin SOIC)*
ZEPIR000102ZCOG	ZMOTION Detection Module Development Kit

Note: \*See Zilog's ZMOTION Detection and Control Product Specification (PS0285), available on Zilog.com.

# Electrical Characteristics

The data in this chapter is prequalification and precharacterization and is subject to change. For additional electrical characteristics, refer to the Z8 Encore! XP<sup>®</sup> F082A Series Product Specification (PS0228).

**Table 10. Electrical Characteristics**

Symbol	Parameter	Min	Typ	Max	Units	Conditions
V <sub>POR</sub>	Power-on Reset Voltage Threshold	2.20	2.45	2.70	V	V <sub>DD</sub> = V <sub>POR</sub>
V <sub>VBO</sub>	Voltage Brown-Out Reset Voltage Threshold	2.15	2.40	2.65	V	V <sub>DD</sub> = V <sub>POR</sub>
T <sub>RAMP</sub>	Time for V <sub>DD</sub> to transition from V <sub>SS</sub> to V <sub>POR</sub> to ensure valid Reset	0.10	—	100	ms	—
T <sub>POR</sub>	Power-on Reset Digital Delay	—	1.0	—	ms	—
V <sub>DD</sub>	Supply Voltage	2.7	—	3.6	V	—
V <sub>IL1</sub>	Low Level Input Voltage	-0.3	—	0.3*V <sub>DD</sub>	V	RXD, /RST, SLP
V <sub>IH1</sub>	High Level Input Voltage	0.7*V <sub>DD</sub>	—	5.5	V	RXD, /RST, SLP
V <sub>OL1</sub>	Low Level Output Voltage	—	—	0.4	V	I <sub>OL</sub> = 2 mA; V <sub>DD</sub> = 3.0V TXD, MD
V <sub>OL2</sub>	Low Level Output Voltage	—	—	0.6	V	I <sub>OL</sub> = 20 mA; V <sub>DD</sub> = 3.3V TXD, MD
V <sub>OH1</sub>	High Level Output Voltage	2.4	—	—	V	I <sub>OH</sub> = -2 mA; V <sub>DD</sub> = 3.0V TXD, MD
V <sub>OH2</sub>	High Level Output Voltage	2.4	—	—	V	I <sub>OH</sub> = -20 mA; V <sub>DD</sub> = 3.3V TXD, MD
I <sub>DD</sub> Active	Supply Current in Active Mode	—	8.9mA	—	—	V <sub>DD</sub> = 3.3V
I <sub>DD</sub> Sleep	Supply Current in Sleep Mode	—	450μA (Typ)	—	—	V <sub>DD</sub> = 3.3V
T <sub>PIR</sub>	PIR Stabilization Time	—	20	—	seconds	—
Z <sub>IN</sub>	Analog Pin Input Impedance	—	550	—	KΩ	DLY, SNS, LG
	Serial Interface Inactivity Time-out	—	2.5	—	seconds	—

## Absolute Maximum Ratings

Stresses greater than those listed in Table 11 can cause permanent damage to the device. These ratings are stress ratings only. Operation of the device at any condition outside those indicated in the operational sections of these specifications is not implied. Exposure to absolute maximum rating conditions for extended periods may affect device reliability.

**Table 11. Absolute Maximum Ratings**

Parameter	Min	Max	Units
Ambient Temperature Under Bias	0	70	°C
Storage Temperature	-65	+150	°C
Voltage on Any Pin with respect to $V_{SS}$	-0.3	+5.5	V
Voltage on $V_{DD}$ Pin with respect to $V_{SS}$	-0.3	+3.6	V
Maximum Output Current from Active Output Pin	-25	+25	mA

# Ordering Information

You can order the ZMOTION Detection Module from Zilog® or any of our authorized distributors using the following part numbers. For more information on ordering, please consult your local Zilog sales office. The Zilog website ([www.zilog.com](http://www.zilog.com)) lists all regional offices and provides additional information about the ZMOTION Detection Module product line.

## Part Numbers

Table 12 lists the part numbers for ZMOTION Detection Module and a brief description of each part.

**Table 12. Part Numbers**

Part Number	Description
ZEPIR0AAS02MODG	ZMOTION Detection Module (right-angle connector)
ZEPIR0ABS02MODG	ZMOTION Detection Module (straight connector)
ZEPIR000102ZCOG	ZMOTION Detection Module Development Kit

## Appendix A. Hardware Interface Mode

The schematic in Figure 11 shows a typical application example of how to use the Module in Hardware Interface Mode.

Hardware Interface Mode is selected because the Sense pin is between 0V and 1.8V. In this example, the DLY and SNS signals are connected to trim pots for control of the  $\overline{MD}$  output activation time and the Motion Detection sensitivity respectively. These connections can also be replaced with fixed resistor values in an application where adjustments are not necessary. The Sleep feature is not being used so the  $\overline{SLP}$  input is left unconnected as there is an internal pull-up resistor to ensure this pin remains inactive. It is also acceptable to tie this pin to  $V_{DD}$ . The  $\overline{MD}$  signal directly drives a solid state relay and is active low. The Light Gate (LG) signal is connected to a CDS photocell in a divider configuration with a potentiometer to adjust the light level. The signal is used by the Module to gate the  $\overline{MD}$  signal such that it does not activate in the presence of daytime ambient light. When the voltage on this pin is lower than 1.0V, the  $\overline{MD}$  signal will not activate even when motion is detected.

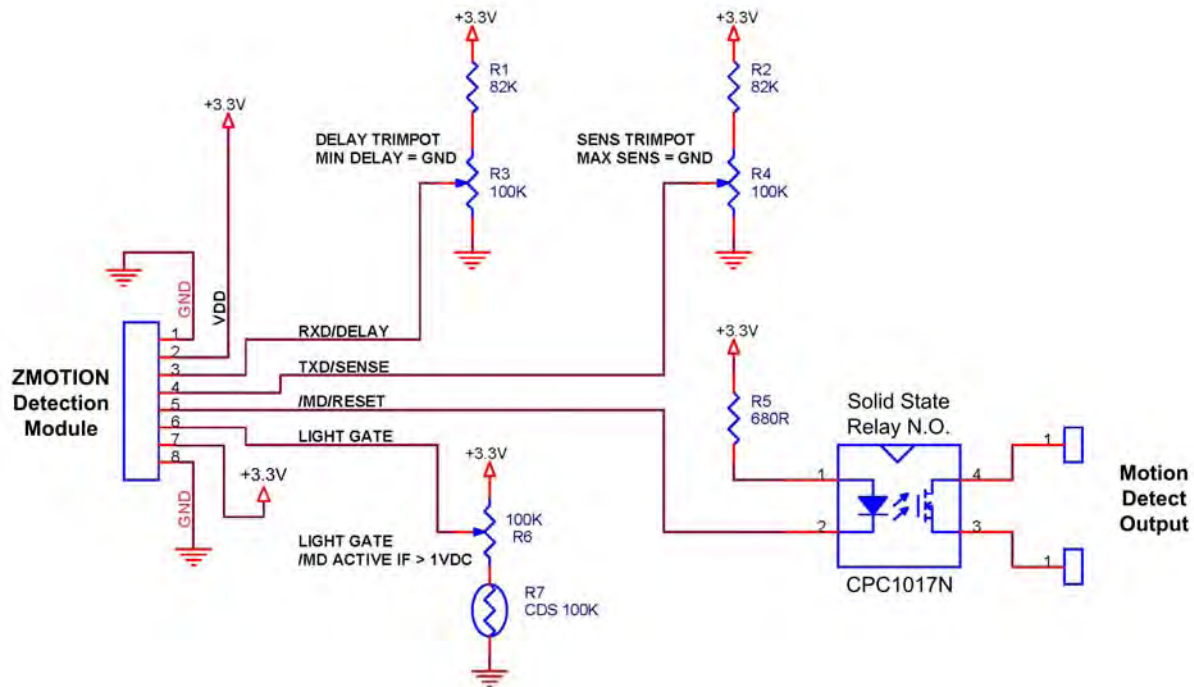

Figure 11. Application Example, Hardware Interface Mode

## Appendix B. Serial Interface Mode

The schematic in Figure 12 shows a typical application example of how to use the module in Serial Interface Mode.

Serial Interface Mode is selected because the TXD pin is pulled High via the 10KΩ resistor R1. This High state is only required to be guaranteed during power up. In this example, the RXD and TXD signals are connected to the TXD and RXD signals (respectively) of the Z8F1680. Since the  $\overline{MD}$  and  $\overline{SLP}$  signals are still active in the Serial Interface Mode, they are also connected to the host MCU. If they were not connected to the MCU,  $\overline{MD}$  would typically drive the control circuitry similar the Hardware Interface Mode and  $\overline{SLP}$  either left unconnected or tied high.  $\overline{SLP}$  has an internal pull-up to ensure proper operation. The Light Gate (LG) signal is connected to a CDS photocell in a divider configuration with a potentiometer to adjust the light level. The signal is used by the Module to gate the  $\overline{MD}$  signal such that it does not activate in the presence of daytime ambient light. When the signal on this pin is lower than the value programmed into the Light Gate Threshold register, the  $\overline{MD}$  signal will not activate even when motion is detected.

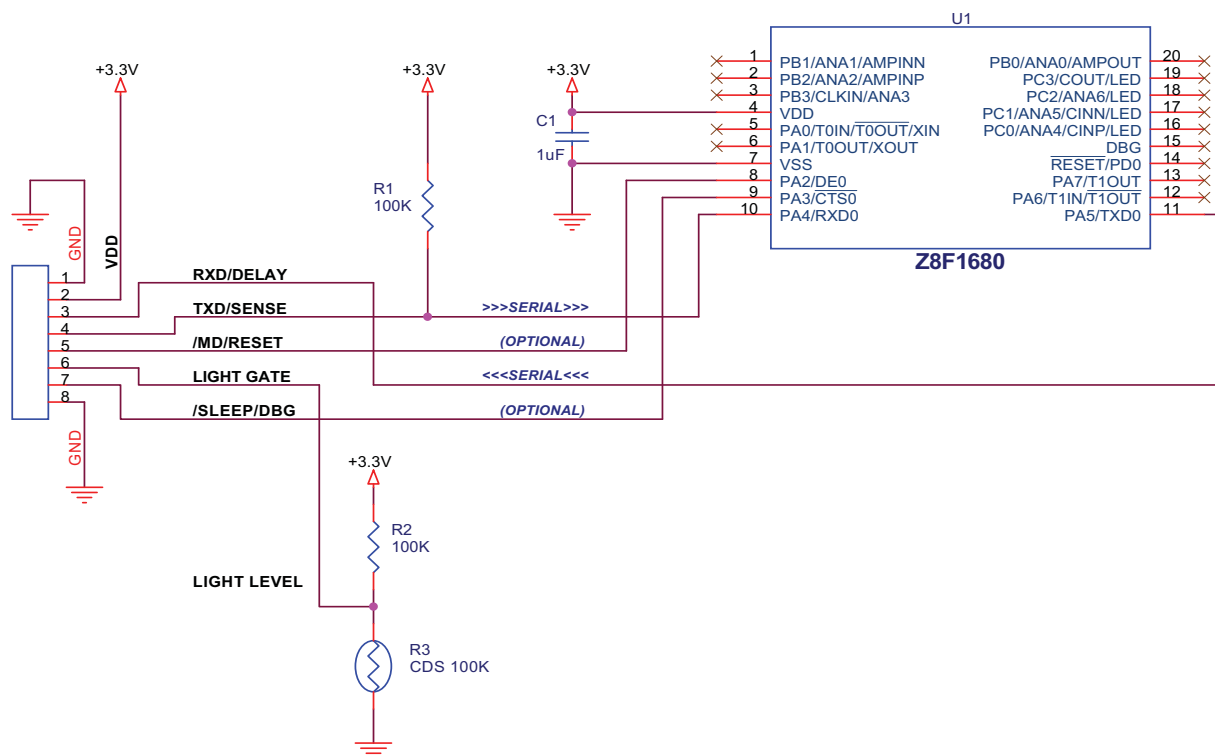

Figure 12. Application Example, Serial Interface Mode



## Appendix C. Software Revisions

**Table 13. ZMOTION Detection Module Software Revision (Application Software)**

Returned Value ('i' command)	S/W Revision	Changes/Updates
1	1.0	Initial Production Release.
2	2.0	Support for additional features in the ZMOTION Detection Module. Added ASCII serial mode, RAM R/W, and sleep timer. Improved SLEEP Mode current.
4	2.0	Support for additional features in the ZMOTION Detection Module. Added ASCII serial mode and sleep timer. Improved SLEEP Mode current.
6	3.0	Fixed issue with 'L' command. Added 'G' and 'g' commands. Fixed range value issue. Fixed issue with LG input when delay is 3 minutes or greater. Added command for Hyper Sense level.

**Table 14. ZMOTION Software Engine Revision**

Returned Value ('i' command)	S/W Revision	Changes/Updates
1	1.0	Initial Production Release.
2	2.0	Release of the ZMOTION Detection MCU. Improved detection/stability. Added Range, Low Power, Hyper Sense, advanced API features.

# Customer Support

To share comments, get your technical questions answered, or report issues you may be experiencing with our products, please visit Zilog's Technical Support page at <http://support.zilog.com>.

To learn more about this product, find additional documentation, or to discover other facets about Zilog product offerings, please visit the Zilog Knowledge Base at <http://zilog.com/kb> or consider participating in the Zilog Forum at <http://zilog.com/forum>.

This publication is subject to replacement by a later edition. To determine whether a later edition exists, please visit the Zilog website at <http://www.zilog.com>.