

# AMMP-6630

## 5 – 30 GHz Variable Attenuator

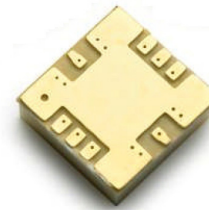

### Data Sheet



#### Description

The AMMP-6630 MMIC is a monolithic, voltage variable, GaAs IC attenuator that operates from 5-30 GHz. It is fabricated using Avago Technologies enhancement mode MMIC process with backside ground vias, and gate lengths of approximately 0.25um. The attenuator has a distributed topology and it helps to absorb parasitic effects of its series and shunt FETs to make it broadband.

#### Package Diagram

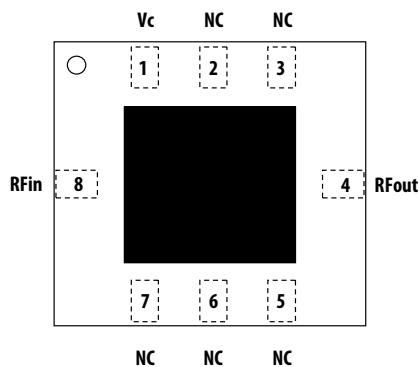

#### Features

- Surface Mount Package, 5.0 x 5.0 x 2 mm
- Wide Frequency Range 5-30 GHz
- Attenuation Range 20dB
- Single Positive Bias Supply
- Unconditionally Stable

#### Applications

- Microwave Radio Systems
- Satellite VSAT, DBS Up / Down Link
- LMDS & Pt – Pt mmW Long Haul
- Broadband Wireless Access (including 802.16 and 802.20 WiMax)
- WLL and MMDS loops

#### Functional Block Diagram

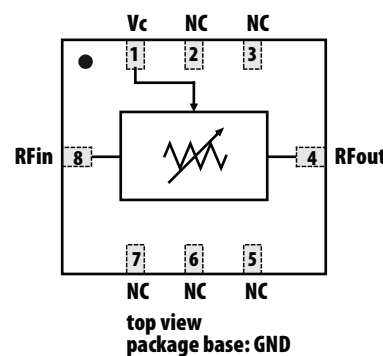

Pin	Function
1	Vc
2	NC
3	NC
4	RFout
5	NC
6	NC
7	NC
8	RFin



**Attention: Observe Precautions for handling electrostatic sensitive devices.**  
 ESD Machine Model (Class A): 70V  
 ESD Human Body Model (Class 1A): 400V  
 Refer to Avago Application Note A004R: Electrostatic Discharge Damage and Control.

Note: MSL Rating = Level 2A

## Electrical Specifications

1. Small/Large -signal data measured in a fully de-embedded test fixture form TA = 25°C.
2. Pre-assembly into package performance verified 100% on-wafer per AMMC-6530 published specifications.
3. This final package part performance is verified by a functional test correlated to actual performance at one or more frequencies.
4. Specifications are derived from measurements in a 50 Ω test environment. Aspects of the amplifier performance may be improved over a more narrow bandwidth by application of additional conjugate, linearity, or low noise (Γopt) matching.
5. NF is measure on-wafer. Additional bond wires (-0.2nH) at Input could improve NF at some frequencies.

**Table 1. RF Electrical Characteristics [1,2]**

TA=25°C, Zo=50 Ω

Parameter	Frequency =7GHz	Frequency =16GHz	Frequency =25GHz	Frequency =34GHz	Unit	Comment
Minimum Attenuation (Reference State)	5	2.5	3.5	3.5	dB	Small Signal S21 Vc=0V
Maximum Attenuation	23.0	22.0	22.5	23.5	dB	Small Signal S21 Vc=0V
Frequency <45 Typical						
RLin and RLout at Reference State	10		dB	Vc=0V		
RLin and RLout at Maximum State	10		dB	Vc=1.0V		

Notes:

1. All tested parameters guaranteed with measurement accuracy ±2.5dB for Min Attenuation of 7GHz , ±1 for Min Attenuation of 16, 25GHz & 34GHz, ±3 for Max Attenuation of 7GHz, and ±2 for Max Attenuation of 16GHz, 25GHz &34GHz.

**Table 2. Recommended Operating Range**

1. Ambient operational temperature TA = 25°C unless otherwise noted.
2. Data obtained from on-wafer measurement

Description	Min.	Typical	Max.	Unit	Test Condition
VC Control Current (Min Attenuation), Ic_ref		0		uA	Vc=0V
VC Control Current (Max Attenuation), Ic_ref		150		uA	Vc=1.0V

**Table 3. Absolute Minimum and Maximum Ratings [1]**

Parameter	Min.	Max.	Unit	Comments
Voltage to Control Attenuation, Vc	0	1.6	V	
RF Input Power, Pin		27	dBm	
Operating Channel Temperature, Tch		+150	dB	
Storage Temperature, Tstg	-40	+150	°C	
Maximum Assembly Temperature, Tmax		300	°C	60 second maximum

Notes:

1. Operation in excess of any one of these conditions may result in permanent damage to this device. The absolute maximum ratings for VC and Pin were determined at an ambient temperature of 25°C unless noted otherwise..

**AMMP-6630 Typical Performance ( $T_A = 25^\circ\text{C}$ ,  $Z_{in} = Z_{out} = 50 \Omega$ )**

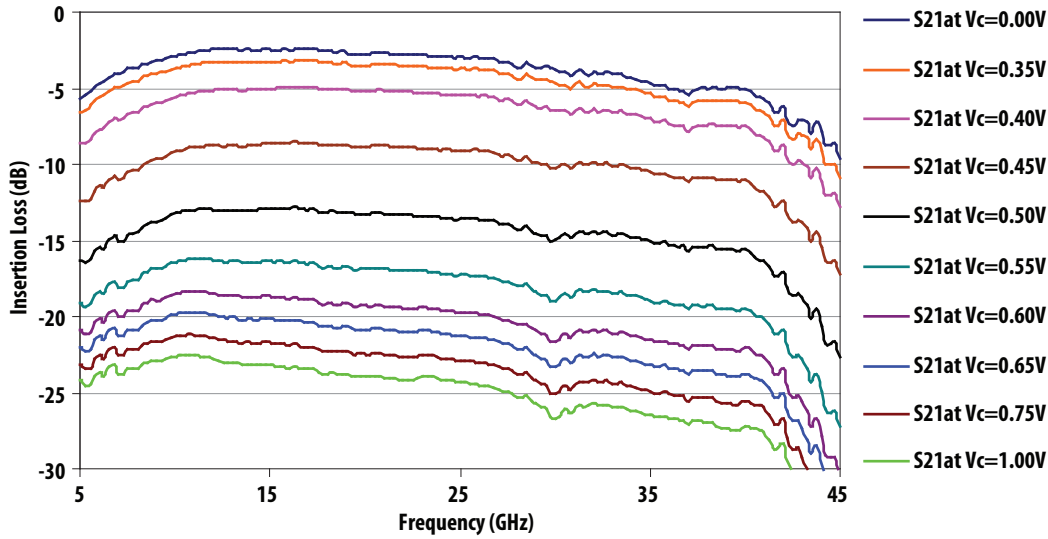

Figure 9. Insertion Loss vs Frequency

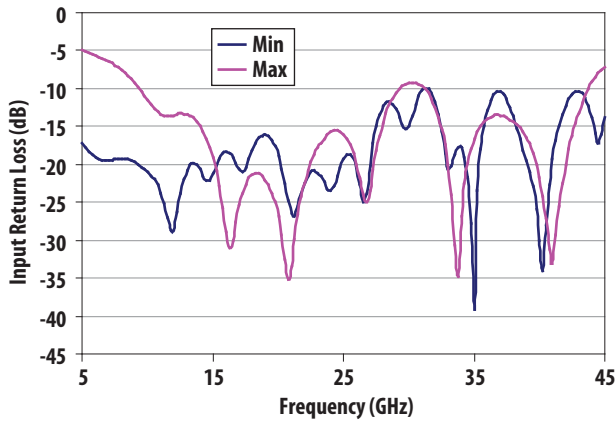

Figure 10. Output Return Loss vs Frequency at Min Attenuation

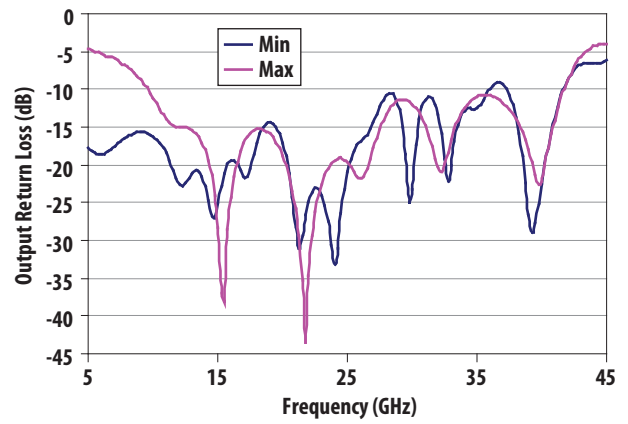

Figure 11. Input Return Loss vs Frequency at Max Attenuation

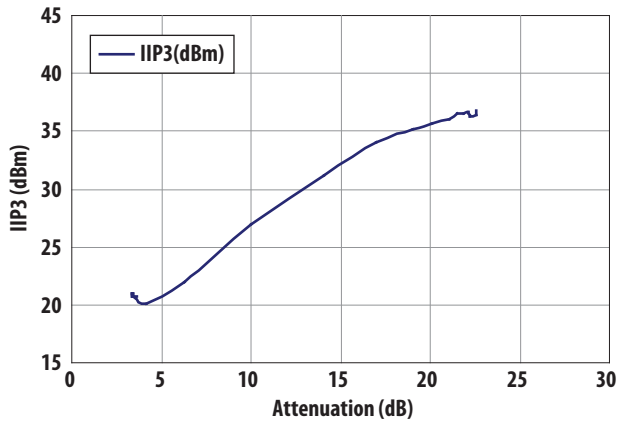

Figure 12a. IIP3 vs Attenuation (Frequency = 7 GHz, Input Power = -10dBm)

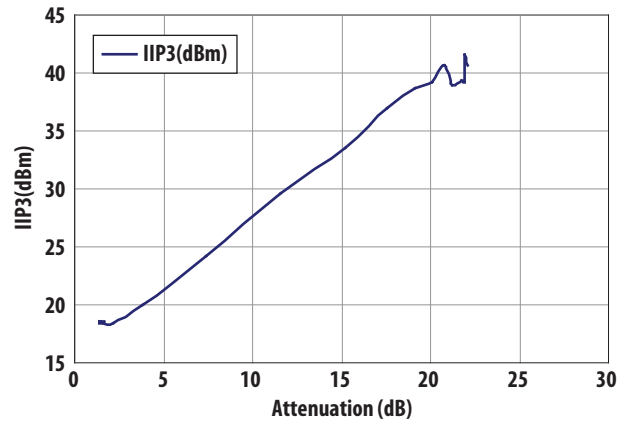

Figure 12b. IIP3 vs Attenuation (Frequency = 16 GHz, Input Power = -10dBm)

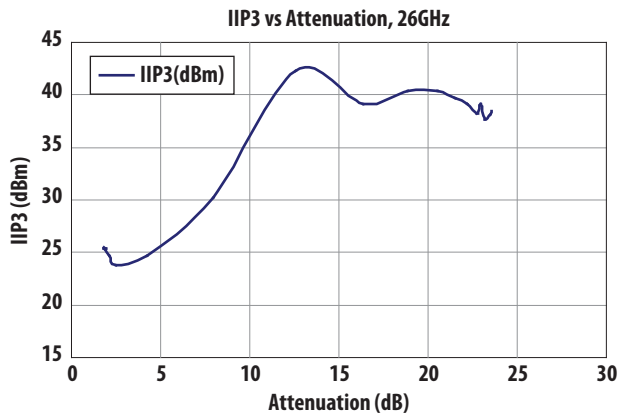

Figure 12c. IIP3 vs Attenuation (Frequency = 25 GHz, Input Power = -10dBm)

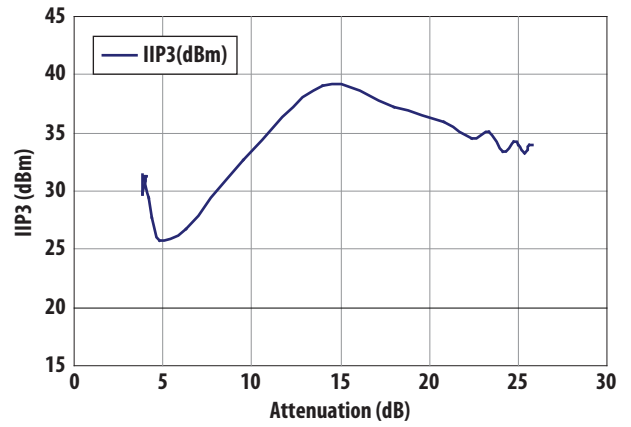

Figure 12d. IIP3 vs Attenuation (Frequency = 34 GHz, Input Power = -13dBm)

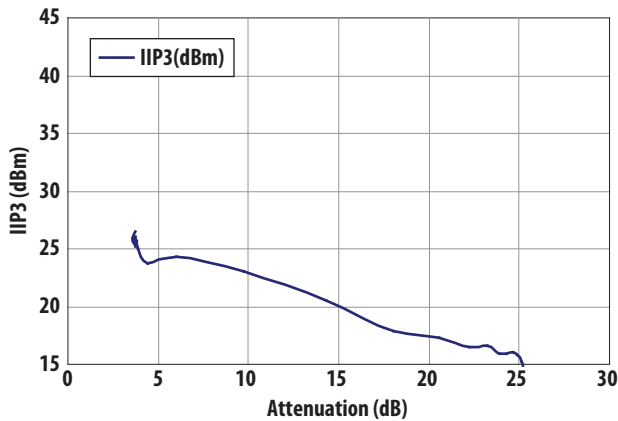

Figure 12e. IIP3 vs Attenuation (Frequency = 42 GHz, Input Power = -16dBm)

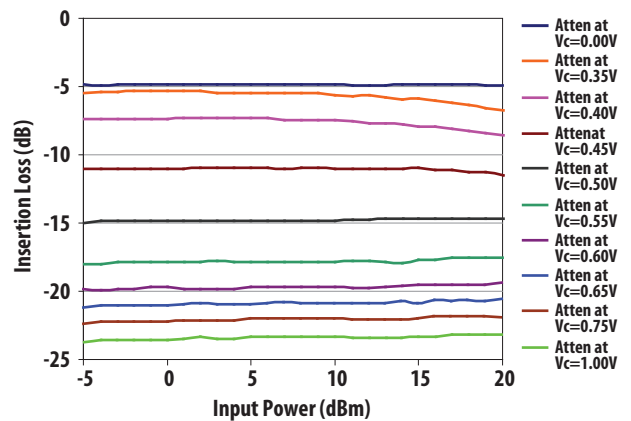

Figure 13a. Attenuation vs Input Power (Frequency = 7 GHz)

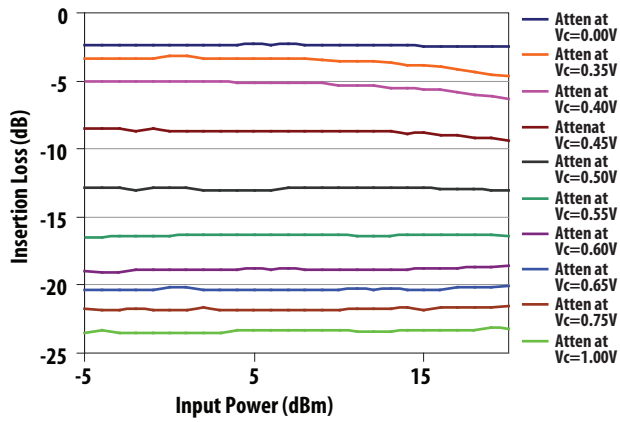

Figure 13b. Attenuation vs Input Power (Frequency = 16 GHz)

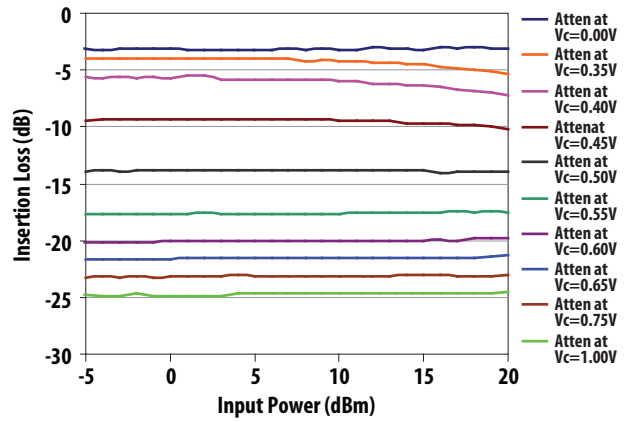

Figure 13c. Attenuation vs Input Power (Frequency = 25 GHz)

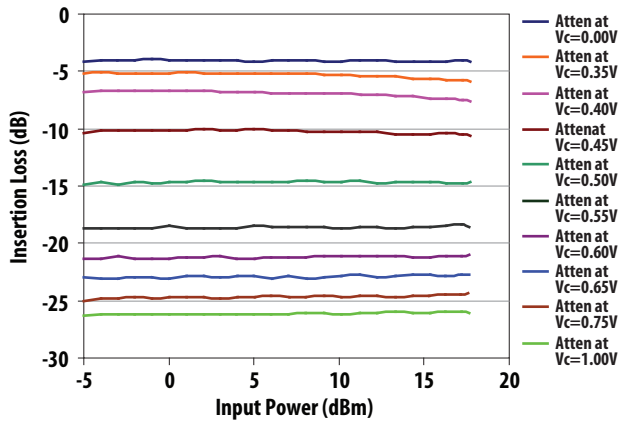

Figure 13d. Attenuation vs Input Power (Frequency = 34 GHz)

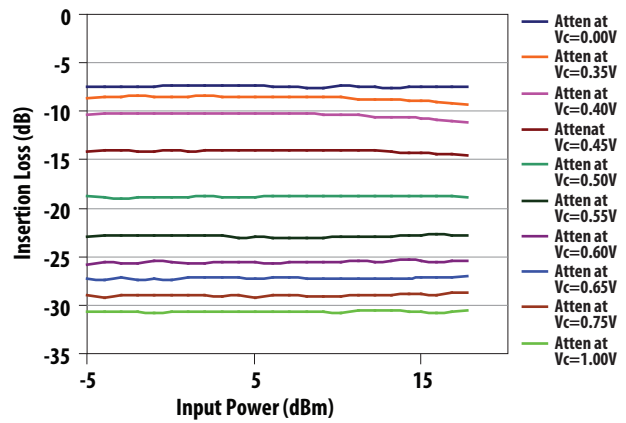

Figure 13e. Attenuation vs Input Power (Frequency = 42 GHz)

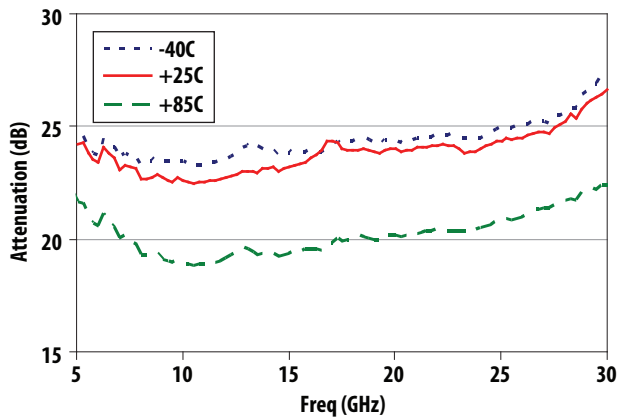

Figure 14. Attenuation vs Frequency (Max Attenuation)

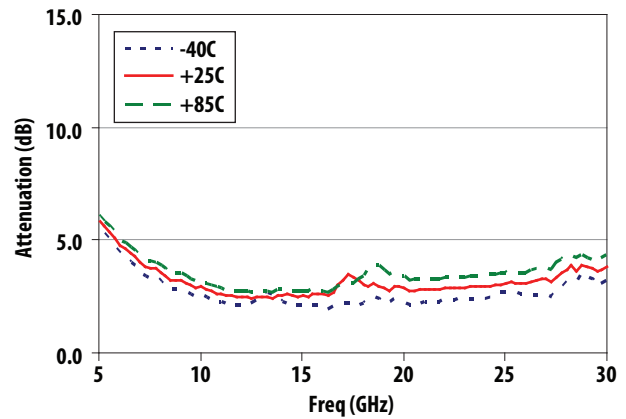

Figure 15. Attenuation vs Frequency (Min Attenuation)

Notes for Figure 12 ~ 13:

1. Attenuation is a positive number, whereas insertion loss  $S_{21}$  measured on a network analyzer is a negative number.

## AMMP-6630 Biasing and Operation

The recommended DC control voltage range is  $V_c=0$  to 1 volt. A simplified schematic for the MMIC die in the package is shown in Figure 16.

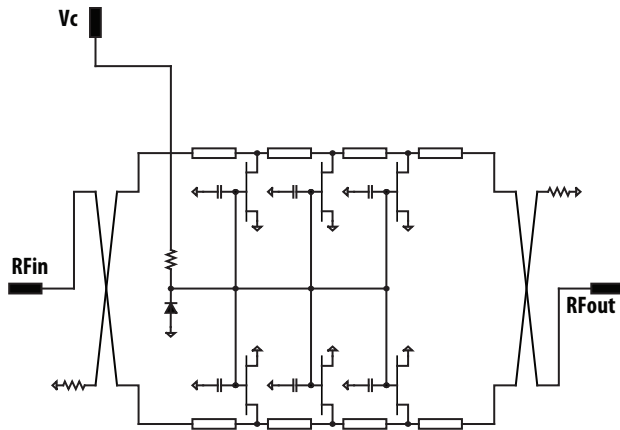

Figure 16. Simplified schematic

## Ordering Information

Part Number	Devices Per Container	Container
AMMP-6630-BLKG	10	Antistatic bag
AMMP-6630-TR1G	100	7" Reel
AMMP-6630-TR2G	500	7" Reel

## Package Dimension, PCB Layout and Tape and Reel information

Please refer to Avago Technologies Application Note 5520, AMxP-xxxx production Assembly Process (Land Pattern A).

For product information and a complete list of distributors, please go to our web site: [www.avagotech.com](http://www.avagotech.com)

Avago, Avago Technologies, and the A logo are trademarks of Avago Technologies in the United States and other countries. Data subject to change. Copyright © 2005-2013 Avago Technologies. All rights reserved. AV02-1753EN - July 9, 2013

**Avago**  
TECHNOLOGIES