

PROJECT NO. SIMILAR ITEM EDP NO. ENG. NO. SD 35272-0610

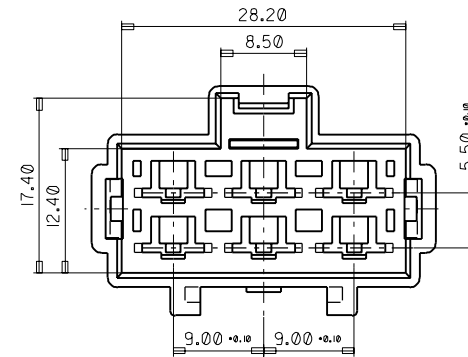
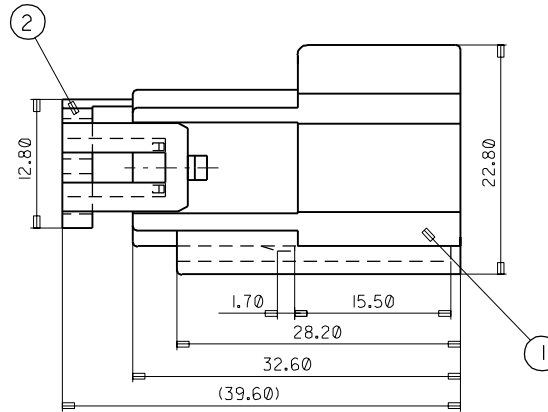
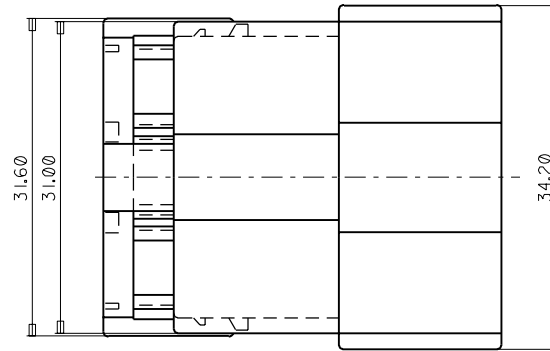
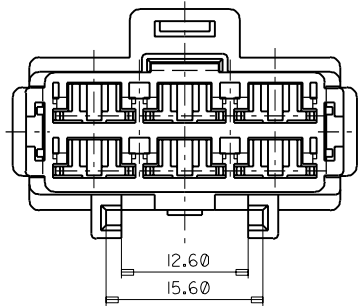

	P/N.O.	PART NAME	MATERIAL
①	35272-0690	POWERMATE MALE HSG 6P	PBT
②	35273-0680	POWERMATE MALE TPA 6P	PBT

* APPLICABLE TERMINAL : 35725-30**,18**,19**

			MATERIAL SEE TABLE		MOLEX-KOREA CO.,LTD.	
			GENERAL TOLERANCE DIMENSION : *0.20		DRAWN BY 961119 J.K.OH	
			ANGLE :		CHK'D BY	
			DIMENSION CLASSIFICATION		APP'D BY	
			▽ : CRITICAL ▼ : MAJOR		SCALE 2 : 1	
			() : REFERENCE		TITLE :	
A NEW RELEASE			KOR1997-0153	971120	POWERMATE MALE ASSY 6P	
LTR REVISION RECORD			ECN	DATE	SHEET 1/1	
REVISE ONLY ON CAD SYSTEM					ENG. NO. SD 35272-0610	
					REV A	