



Mallory Sonalert Products, Inc.

Part #:

SCH648R

Sales Outline Drawing

Revision:

D

Specifications:

HAZARDOUS LOCATION ALARM

Sound Level Category	Medium
Mode of Operation	Continuous
Voltage Rating	10 to 48 VDC
Frequency	2900 ± 500 Hz
Loudness @ 2 FT	68 to 80 dB(A) Typ.
Current Draw	5-22mA
Housing Material	6/6 Nylon, Color: Black
Storage Temperature	-40° to +85° C
Operating Temperature	-30° to +65° C
Environmental Approvals	NEMA 3R, 4X & 12; IP-66; CSA C22.2 No. 94; CSA C22.2 No. 213-M1987; Hazardous Loc. Class I, Div II, Grps A, B, C & D
Panel Mounting	Recommended hole size is 1.25"(31.75mm). Thread front will fit standard 30mm(1.181") hole.
Mounting (see note B)	Gasket (included with alarm) must be used to ensure compliance to all environmental approvals.
Weight (Typical)	1.6 oz (45g)
Options	Please contact factory.

Dimensions:

Inches (mm)

cUL Recognized

ROHS Compliant

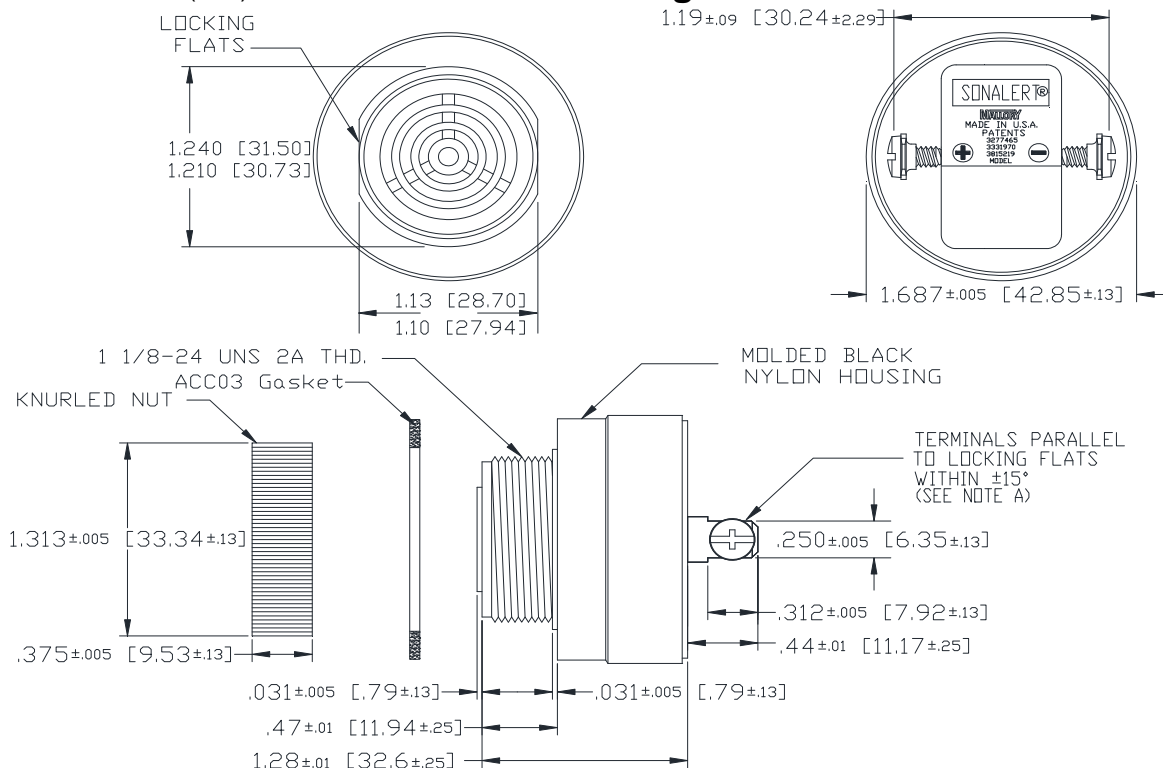

NOTE A: TERMINALS-.032 BRASS TIN PLATED, TAPPED FOR #6-32 SCREW. TWO #6-32 NICKEL PLATED BRASS SCREWS INCLUDED. WILL ACCEPT 1/4" QUICK CONNECT.

NOTE B: MOUNTING- REMOVE BLACK PLASTIC NUT AND ASSEMBLE ACCO3 GASKET ONTO THREADED NECK. INSERT THREADED FRONT THROUGH 1.25" HOLE PUNCHED IN PANEL, IF ORIENTATION IS NEEDED, NOTE LOCKING FLATS ON DRAWING. SCREW NUT BACK ON. HAND TIGHTEN ONLY.